

Digital Edition

Digital Editions of selected Intel Press books are in addition to and complement the printed books.

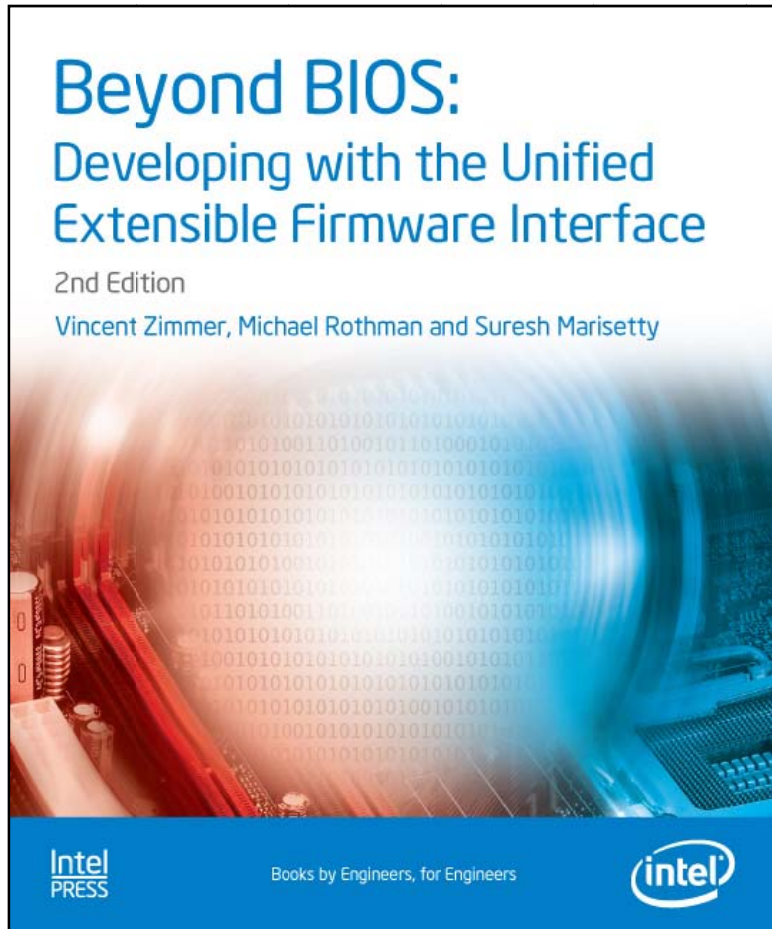

Click the icon to access information on other essential books for Developers and IT Professionals

Visit our website at www.intel.com/intelpress

Beyond BIOS

Developing with the Unified Extensible
Firmware Interface

Second Edition

Vincent Zimmer
Michael Rothman
Suresh Marisetty

Intel

PRESS

Copyright © 2010 Intel Corporation. All rights reserved.
ISBN 13 978-1-934053-29-4

This publication is designed to provide accurate and authoritative information in regard to the subject matter covered. It is sold with the understanding that the publisher is not engaged in professional services. If professional advice or other expert assistance is required, the services of a competent professional person should be sought.

Intel Corporation may have patents or pending patent applications, trademarks, copyrights, or other intellectual property rights that relate to the presented subject matter. The furnishing of documents and other materials and information does not provide any license, express or implied, by estoppel or otherwise, to any such patents, trademarks, copyrights, or other intellectual property rights.

Intel may make changes to specifications, product descriptions, and plans at any time, without notice.

Fictitious names of companies, products, people, characters, and/or data mentioned herein are not intended to represent any real individual, company, product, or event.

Intel products are not intended for use in medical, life saving, life sustaining, critical control or safety systems, or in nuclear facility applications.

Intel, the Intel logo, Celeron, Intel Centrino, Intel NetBurst, Intel Xeon, Itanium, Pentium, MMX, and VTune are trademarks or registered trademarks of Intel Corporation or its subsidiaries in the United States and other countries.

† Other names and brands may be claimed as the property of others.

This book is printed on acid-free paper. ♻️

Publisher: Richard Bowles

Editor: David J. Clark

Program Manager: Stuart Douglas

Text Design & Composition: InfoPros

Graphic Art: Ted Cyrek (cover) InfoPros (illustrations)

Library of Congress Cataloging in Publication Data:

10 9 8 7 6 5 4 3 2 1

First printing, November 2010

To my wife Jan, and my daughters Ally and Zoe, without whose love this book would not have been possible. To my parents Stanley and Joann, and my sister Natalie, who have helped me on my journey through life.

—Vincent Zimmer

To my wife Sandi for having infinite patience in allowing me to find the “spare” time for this endeavor, and to my sons Ryan and Aaron who keep me grounded in what life is really about.

—Mike Rothman

To my very supporting spouse Anitha, my son Ketan and daughter Manisha for being the source of inspiration in my life.

—Suresh Marisetty

Contents

Contents v

Foreword to the First Edition xi

Foreword to the Second Edition xv

Preface xix

Chapter 1 Introduction 1

Terminology 5

A Short History of EFI 6

EFI Becomes UEFI—The UEFI Forum 7

PIWG and USWG 10

Platform Trust/Security 14

Embedded Systems: The New Challenge 17

Summary 19

Chapter 2 Basic UEFI Architecture 21

Objects Managed by UEFI-based Firmware 22

UEFI System Table 22

Handle Database 23

Protocols 26

Working with Protocols 30

Tag GUID 31

- UEFI Images 31
- Events and Task Priority Levels 37
- Summary 41

Chapter 3 UEFI Driver Model 43

- Why a Driver Model Prior to OS Booting? 44
- Driver Initialization 44
- Host Bus Controllers 46
- Device Drivers 48
- Bus Drivers 50
- Platform Components 52
- Hot Plug Events 53
- Additional Innovations 63
- Summary 67

Chapter 4 Protocols You Should Know 69

- EFI OS Loaders 71
- Device Path and Image Information of the OS Loader 74
- Accessing Files in the Device Path of the OS Loader 75
- Finding the OS Partition 76
- Getting the Current System Configuration 77
- Getting the Current Memory Map 78
- Getting Environment Variables 79
- Transitioning to an OS Kernel 80
- Summary 81

Chapter 5 UEFI Runtime 83

- Isn't There Only One Kind of Memory? 85
- How Are Runtime Services Exposed? 88
- Time Services 89
- Virtual Memory Services 92
- Variable Services 94
- Miscellaneous Services 98
- Summary 101

Chapter 6	UEFI Console Services	103
	Simple Text Input Protocol	106
	Simple Text Input Ex Protocol	109
	Simple Text Output Protocol	110
	Remote Console Support	113
	Console Splitter	116
	Network Consoles	118
	Summary	120
Chapter 7	Different Types of Platforms	121
	Summary	138
Chapter 8	DXE Basics: Core, Dispatching, and Drivers	139
	DXE Core	141
	Global Coherency Domain Services	152
	DXE Dispatcher	157
	DXE Drivers	162
	Boot Device Selection (BDS) Phase	163
	Summary	166
Chapter 9	Some Common UEFI and PI Functions	167
	Architectural Protocol Examples	168
	PCI Protocols	177
	Block I/O	188
	Disk I/O	190
	Simple File System	192
	Configuration Infrastructure	194
	Using the Configuration Infrastructure	196
	Driver Model Interactions	197
	Provisioning the Platform	201
	Summary	203

Chapter 10 Platform Security and Trust 205

- Trust Overview 206
- Trusted Platform Module (TPM) and Measured Boot 209
- UEFI Secure Boot 221
- UEFI Executable Verification 222
- UEFI Networking 224
- UEFI User Identification (UID) 227
- Hardware Evolution: SRTM-to-DRTM 228
- Platform Manufacturer 229
- Vulnerability Classification 231
- Roots of Trust/Guards 232
- Summary 232

Chapter 11 Boot Device Selection 235

- Firmware Boot Manager 238
- Globally-Defined Variables 242
- Default Behavior for Boot Option Variables 245
- Boot Mechanisms 246
- Summary 248

Chapter 12 Boot Flows 249

- Defined Boot Modes 250
- Priority of Boot Paths 251
- Reset Boot Paths 253
- Normal Boot Paths 254
- Recovery Paths 257
- Special Boot Path Topics 259
- Architectural Boot Mode PPIs 264
- Recovery 265
- Summary 266

Chapter 13 Pre-EFI Initialization (PEI) 267

- Scope 268
- Rationale 268

Phase Prerequisites 273

Concepts 274

Operation 279

Summary 289

Chapter 14 Putting It All Together—Firmware Emulation 291

Virtual Platform 292

Hardware Pass-Through 300

Summary 302

Chapter 15 Reducing Platform Boot Times 303

Proof of Concept 308

Marketing Requirements 309

Additional Details 315

Summary 320

Chapter 16 Embedded Boot Solution 323

CE Device Landscape 324

CE Device Boot Challenges 325

In-Vehicle Infotainment 328

Other Embedded Platforms 331

Generic Requirements 332

Boot Strategies 335

Power Management 337

Boot Storage Devices 337

Security 340

Manageability 344

Summary 345

Chapter 17 Manageability 347

Overall Management Framework 348

UEFI Error Format Standardization 351

Windows Hardware Error Architecture and the Role of UEFI 358

x ■ Beyond BIOS: Developing with the Unified Extensible Firmware Interface

Technology Intercepts: UEFI, IPMI, Intel® AMT, WS-MAN 364

The UEFI/IPMI/Intel® AMT/WS-MAN Bridge 370

Summary 372

Data Types 373

Status Codes 377

Index 381

Foreword to the First Edition

Beyond BIOS. Those two words began to circulate through the elite firmware architects and developers in the industry standard computing circle around 1998, when Intel, Microsoft, HP and a number of other companies began to lay out the plan for bringing up the first Intel® Itanium® systems. The plan was originally called IBI, the Intel Boot Initiative. Mainstream PCs had been using BIOS ever since the beginning of the IBM PC. Its drawbacks and limitations were magnified in the “big iron” machines based on the Itanium processors. For example, BIOS depends on many of the PC-AT hardware such as the 8254 timer and 8259 interrupt controller, which were not designed to scale to larger servers like the HP Integrity Superdome[†] servers. Worse, BIOS assumes a 1MB execution memory limit and has very limited memory space to execute the Option ROMs on the add-in cards. BIOS’ 16-bit nature stifles the platform advancement for Itanium systems that are 64-bit based.

There have been non-BIOS solutions in the more proprietary vertical integrated systems design, such as Open Firmware used by IBM Power[†], SUN SPARC[†], and Apple PowerPC[†]; ARCS[†] by DEC Alpha, and PDC/IODC[†] by HP PA-RISC. Open Firmware is Forth-based, it is difficult to find the talent, and its specifications have not kept up with the evolution of the technology. ARCS lacks the driver model to support add-in cards. With BIOS hitting the wall and no clear alternative that can be brought into the industry standard arena, Intel spearheaded the IBI, which at this stage is named Extensible Firmware Interface (EFI), to reflect objective of the effort. EFI brought the modern computer software architectural concepts into firmware. EFI enables firmware development in high-level languages like C, provides proper

abstraction of hardware, and enables extensibility through the GUID concept. The benefits of EFI were so convincing that Microsoft and the industry made it the only boot mechanism for the Itanium-based systems.

Now that the IA-32 processors are also extended to 64-bit via Intel® 64, the industry is working on Unified EFI (UEFI) as the standard pre-boot firmware infrastructure going forward. Intel also spearheaded the effort on the Intel Platform Innovation Framework for EFI (Framework). The Framework is Intel's implementation of EFI, and it is also the starting point for the industry to define the Platform Initialization (PI) specifications that establish the firmware internal interface architecture as well as firmware-to-silicon interfaces that enable silicon driver modularity and interoperability. With Framework's implementation of UEFI and PI, Intel has completed the task of replacing BIOS, thus enabling the industry to move beyond BIOS.

This book is a landmark in the development of the UEFI and PI firmware. It couples a powerful, modern firmware infrastructure with a unique look into the mind of a few UEFI/PI architects who have made the Framework implementation into reality and as a reference. It's accessible to the student in firmware development, yet conveys a deep technical understanding of the UEFI/PI architecture and the Framework implementation. It covers all major areas of the Framework implementation that the firmware developers need to understand. Using this book along with the EFI Development Kit (EDK) code on the TianoCore.org open source project would be an excellent tutorial for the firmware engineers to move *beyond BIOS*.

Vincent Zimmer has been running the PI Working Group meetings and Michael Rothman has been running the UEFI Specification Working Group meetings, helping the Chair of both groups, Mark Doran. Vincent has also been very involved in the Trusted Computing Group, defining security related extensions for EFI. Michael Rothman and Robert Hale are also the lead forces in the development of the Human Interface Infrastructure coming up in the next generation of the UEFI Specification. These authors are some of the elite EFI architects who have helped bring the dream of moving beyond BIOS into reality, thus among the best possible teachers of this subject matter.

This book is for you if you'd like to understand the UEFI/PI architecture and the Framework implementation; that is, to understand how to move beyond BIOS. It gives you all the technical background to understand Bill Gates' WINHEC 2006 Keynote Speech when he said: "There are changes across the board, in terms of how hardware and software work together. If we think about

boot, we're finally moving away from the old BIOS to this unified extensible firmware interface, and that gives us new flexibility and capability, and it's got a rich API set to build on, so many of you are working with us on that." For any student in this field, this book provides an important bridge between normative specifications and the informative details of the development.

Today, Itanium-based systems are no longer the only machines supporting EFI. All the Intel®-based Apple Mac[†] systems are supporting EFI. Systems based on Intel® 64 IA-32 processors are also in the process of supporting UEFI. Embedded systems are also making use of the UEFI/PI architecture in its specialized environment. Operating systems, such as Windows[†], Linux[†], HP-UX[†], Open VMS, FreeBSD, and so on are already EFI-based on Itanium-based systems. Windows, Linux and OS-X[†] are in the process of supporting UEFI on Intel® 64 IA-32 processor-based systems. Currently OS-X already supports EFI on the IA-32 processor-based Mac systems.

This book is the first to describe in detail the Framework implementation of UEFI and PI architecture. I am very pleased to recommend this new must-read to you who may have been living in the BIOS world for so long to see the life beyond BIOS as envisioned by Bill Gates. I also recommend that readers take full advantage of the open source TianoCore.org. Sample code is worth a thousand words. The EDK is a great companion for the book.

Dong Wei

Vice President and Chief Executive, the Unified Forum

HP Distinguished Technologist

Granite Bay, California

June 18, 2006

Foreword to the Second Edition

One weekend this summer in the Silicon Valley, I was at a party hosted by an executive from a hard disk drive manufacturer. Many of the people there are in the computer industry. Inevitably the conversations were around the hot topics in the industry, most notably cloud computing. While people were busy explaining what they know about the cloud and all the \$aaS (everything as a service), the executive declared that he would be happy as long as cloud means more demands for the storage capacity. He said his company is ready to ship hard disk drives with 3 TB, but he claims that the industry is not entirely ready to support these storage devices. The room went quiet. Not all the people there understood what he was talking about, but all wanted to know why the industry that is seemingly able to support all the grandiose concepts human beings can think of has difficulty handling this seemingly easy task. What he said next excited me.

“Beyond BIOS.” The executive spoke of these two words. My moment came to explain to the crowd the root of the problem. It is amazing to see the ah-hah moment when they see the definition of the Master Boot Record (MBR) that we have been using to boot a PC from a hard disk drive since the dawn of PC. It allows for partition size of up to 2 TiB (or 2.2 TB), assuming today’s 512-byte sector size. “How come our high-paying architects have not solved this simple problem?” one asked. I told them that a solution based on the Unified Extensible Firmware Interface (UEFI) GUID-Partition Table (GPT) disk format has been in existence for over a decade now (support for GPT disks is available for all Itanium-based systems) and Windows[†] has supported GPT data disks since Windows XP and GPT boot disks since Windows Vista SP1

on x64. “Then why are we not entirely ready and how do we get the industry entirely ready?” asked another. The best approach is to have all the computers support the UEFI boot from GPT format hard disk drives! I mentioned this book to the crowd. The crowd started to get the terms, UEFI, GPT...

Time is ripe for the second edition of this book. Tremendous progresses have been made since the publication of the first edition more than four years ago. Time went by fast. It would have been hard to believe then, but the majority of the x64 systems are now based on the UEFI technology (even though some may not have exposed the UEFI boot interface). Many vendors spearheaded the support for the UEFI boot on their systems, among them, Apple iMac[†], HP commercial notebooks, IBM System X[†] servers and Dell PowerEdge[†] servers. The UEFI Forum has also defined support for many new UEFI interfaces including network boot over IPv6, ARM[†] processor binding, security enhancements, human interface infrastructure enhancements, and so on. In addition, the UEFI Forum also evolved what was known as “Framework” to Platform Initialization (PI) to define the phases of control from the platform reset into the UEFI environment and to establish the firmware internal interface architecture as well as firmware-to-silicon interfaces that enable silicon driver modularity and interoperability. The resulting modularity made PI the preferred implementation of UEFI. In the mean time, the open source implementation of UEFI has gone through some changes. With the evolution of Framework to PI, EFI Development Kit (EDK) II was introduced to better realize the modularity and reuse. EDK II also contains the ARM and Itanium port, in addition to the x64 port. Going forward, it is foreseeable that EDK II will become the common converged firmware infrastructure across the compute continuum. More recently, Intel named a release of EDK II as UDK2010. It signifies that there is a UEFI Development Kit now matching the UEFI Specifications as of January 2010 (namely UEFI v2.3 and PI v1.2). As a matter of fact, IBM System X servers as well as HP Superdome[†] 2 and Integrity[†] servers have been leading the way in transitioning to EDK II and are in the process of updating to UDK2010 as we speak. This is the perfect time to update the book.

This book is for you if you’d like to understand the UEFI/PI architecture; that is, to understand how to move beyond BIOS. This book provides an important bridge between normative specifications and the informative details of the development. Now it has been updated to match the latest UEFI Specifications and the EDK II codebase along with its UDK2010 release. I am very pleased to recommend this new must-read to you, and please take full advantage of the open source EDK II code base hosted by SourceForge.

EDK II is a great companion of this book. This book is a landmark in the development of the UEFI and PI firmware. It couples a powerful, modern firmware infrastructure with a unique look into the mind of a few UEFI/PI architects.

Vincent Zimmer and Michael Rothman were the original authors I introduced; they continue to be the driving forces behind UEFI and PI Specifications and significantly contributed to the update of this book. For example, Vincent, as the chair of the UEFI Networking Sub-team, took the lead to work with the Internet Engineering Task Force (IETF) to define the network boot over IPv6, as the IPv4 addresses run out. Michael, as the chair of the UEFI Shell Sub-team, led the effort for the standardization of the UEFI Shell. Suresh Marisetty is a new author but he is anything but new to this field. He worked on Itanium machine check code and subsequently Windows Hardware Error Architecture (WHEA), and most recently has been involved with the end-to-end boot solution for the embedded market.

The move beyond BIOS to UEFI/PI brings many benefits. GPT formatted hard disk drives allow for partition size of up to 8 ZiB (or 9.4 TB), assuming today's 512-byte sector size, and can support more than 4 partitions. 64-bit code architecture removed the 1 MB and 4 GB execution memory limit associated with BIOS, along with the 192 KB limited memory space for the boot drivers on the add-in cards. Adapter vendors are enabled to easily add functions. The time has come for the computers to support UEFI boot. A Compatibility Support Module (CSM) can still be provided on a UEFI system to support booting the legacy operating systems, but its role is fading, so the authors have decided to leave it out of this second edition. Moving UEFI/PI to the embedded market is promising, in addition to the natural application to the systems based on the x64 embedded processors such as Intel Atom[†]. EDK II has been ported to ARM BeagleBoard as a reference, Apple devices and HP printers are already using the UEFI technology—obviously the opportunities there are endless. Let's now embrace the UEFI/PI technology fully and explore what more value-add features will be possible on the horizon. FaaS (firmware as a service), anyone?

Dong Wei

Vice President (Chief Executive), the UEFI Forum

Secretary, the ACPI SIG

Chair, The PCI SIG Firmware WG

Preface

There are two mistakes one can make on the road to truth... not going all the way, and not starting.

— Buddha

This is a book about a new way to solve an old set of problems that are persistent as well as fundamental, but not always well understood: How should you boot a computer? What sits at the reset vector? What can the operating system count on when it is loaded and initially receives control? What should the internal structures be between these two endpoints? How can the same basic structure work for handhelds and megaservers? How do we convince ourselves today's design will work 10 or 20 years from now? How much will it cost to switch? How much will it cost steady state? What comes after BIOS (Basic Input/Output System)?

Beyond BIOS is a book about a largely invisible subject. The general user, if they have any view of BIOS at all, tends to view it as ten unnecessary seconds on the way to booting the operating system or as setup. The community that knows and uses the BIOS has tended to view it as an uncontrolled place of kludge, myth, bug, and legend. The very small community of BIOS developers has viewed their code not only as highly mutable and embodying much of the compatibility that has made the PC and its offspring so successful, but also as their livelihood.

This is a book that is about what comes after BIOS, which we call the Unified Extensible Firmware Interface (UEFI) and Platform Initialization (PI). In doing so, it must also be a book at least partly about what a BIOS or its replacement is called upon to do. It is not a cookbook on how to port the PI from platform to platform. It is not a rehash of the specifications. Instead, it

tries to fit in the middle ground between specifications and cookbook. It tries to focus on the concepts and constructs that are cross-platform and implied, if not stated, by the architecture. It is supposed to help to get to some of the “why” behind the specs and make the porting work make some sense.

This book is a child of its time. Both the UEFI and the PI are under the control of the UEFI Forum, an industry-wide group in which you are encouraged to participate. *Beyond BIOS* mainly focuses on the current state of the PI and UEFI since the 2005 formation of the Forum, its working groups, and its sub-teams. This is not to say that this is only a history book or a simple summary of the standard. Instead, we believe it remains valuable as an introduction to the newer versions of the specifications no matter who “has the pen.”

The Chapters

Chapter 1 provides a description of the evolution.

This rest of the book is organized into two major sections. The earlier chapters present an introduction to UEFI, and the later chapters cover the Platform Initialization.

Chapter 2 provides an overview of the basic UEFI architecture. This is a must-read for anyone seeking an understanding of the Unified Extensible Firmware Interface (UEFI).

Chapter 3 describes the UEFI driver model. This is important for vendors writing device drivers for output devices (such as video), input devices (such as keyboards or mice), networking adapters, and block devices. These drivers can be stored in the host-bus adapter, the platform ROM, or loaded from the UEFI system partition.

Chapter 4 describes of series of commonly used UEFI protocols. This chapter complements the earlier two chapters and includes data on additional boot services application interfaces.

Chapter 5 includes information on the UEFI runtime operational environment. This chapter is important for operating system vendors who need to interact with the platform during the operating system execution.

Chapter 6 describes UEFI input and output console services. This chapter provides details on the particular capabilities, interfaces, and relationships of the console services.

Chapter 7 includes a list of different platforms and the Platform Initialization-based implementations. This chapter demonstrates the flexibility

of the Platform Initialization by mapping the infrastructure to widely varying hardware platforms.

Chapter 8 describes the basics of the Platform Initialization Driver Execution Environment (DXE). This is important to read for anyone working on the phase of execution prior to UEFI service availability but after early Pre-EFI initialization (PEI).

Chapter 9 describes some common UEFI interfaces. This chapter includes information on interfaces that are important for both UEFI and DXE development.

Chapter 10 describes UEFI and platform initialization issues around security and platform trust. This is important because beyond the basic UEFI and Platform Initialization specifications, which describe mechanism, further discussion is included on composition and construction of technology.

Chapter 11 describes Boot Device Selection (BDS). This includes the policy by which Framework platforms decide look-and-feel, in addition to how to boot.

Chapter 12 describes the various boot flows that can occur within a platform. These include power-event restarts, and so on.

Chapter 13 describes the Pre-EFI Initialization environment. This is the phase of execution that occurs after reset and is responsible for the early hardware state and memory initialization.

Chapter 14 includes information on emulation of a firmware environment within an operating system.

Chapter 15 describes mechanisms and capabilities for reducing platform boot time. Since “visible” firmware is often broken firmware, decreasing time for a system restart is key.

Chapter 16 describes the application of firmware for an embedded boot solution. The bulk of shipping systems are embedded computing environments, so the use of UEFI and Platform Initialization for this class of system is becoming more important.

Chapter 17 includes details on manageability. The platform and firmware play a pivotal role in both bare-metal, OS-absent scenarios and also as a complement to OS runtime manageability usages.

The Appendixes include source code data types and commonly-used interfaces.

Acknowledgements

The authors recognize the efforts and contribution of the two men and a dog: Mark Doran, Ken Reneris, and Andrew Fish, who conceived and hatched EFI.

The authors recognize and thank the other original Framework (Tiano) architects Andrew Fish, Bob Hale, Mike Kinney, Barnes Cooper, Will Stevens, Krithivas, ER Uber, Mahesh Natu, Rahul Khanna, Jim Ewertz, Kirk Brannock, and others whose names are lost to time and the team's intrepid leader, Mark Doran. We thank Isaac Oram, John Lambino, and the entire Tiano Architecture Team (TAT) team for fleshing out and enhancing the architecture. Thank you to the Tiano engineering team for their patience while implementing the first versions and to our internal and external customers. The innovation in this book is from these fertile brains. Also, many of this team will recall over ten years of "design discussions" at R&R.

We thank our managers, past and present, for giving us the chance and the time to work on the architecture and this book including Doug Fisher, Richard Wirt, Stu Goossen, Mike Richmond, Kah Loh, Jeff Griffen, Michael Greene, Ju Lu, and Ron Story.

We acknowledge the ever-supportive marketing team: Shala, Laurie, Harry, Fadi, Elmer, and Bailey.

No Intel Press book is published without peer review. We'd like to thank all the reviewers for identifying errors and for providing valuable insight and encouragement along the way. Without their help, this book would not have been a success. From Intel, these individuals participated, at one time or another, in the review of this project: Rob Branch, Mallik Bulusu, Brad Davis, Michael Krau, John Suresh Kumar, Matthew Parrish, Mike Richmond, Lee Rosenbaum, and Sudhakar Otturu. Other reviewers included Cameron Esfahani from Apple Computer Corporation, Todd Greene from QLogic Corporation, Penny Huang from MicroStar International Company, Limited, Jimmy Hwang from American Megatrends, Incorporated, and Dong Wei from Hewlett-Packard Development Company, L.P.

A book like this describes the efforts of a large number of talented individuals. The authors would like to thank all of them for their efforts and support. Please accept our apologies if we missed you. We can only say that space is as limited here as it is in ROMs and time as limited here as it is in schedules. We'll try to fix it in the next release.

Finally, we'd like to thank the team from Intel Press. Stuart Douglas was the content architect for this project—his steady guidance and ability to find resources as we needed them kept this book on track. David Clark was the editor on the project, and helped take our engineering prose and turn it into a real book.

Chapter 1

Introduction

The suddenness of the leap from hardware to software cannot but produce a period of anarchy and collapse, especially in the developed countries.

—Marshall McLuhan

This chapter provides an overview of the evolution of the Extensible Firmware Interface (EFI) to the Unified Extensible Firmware Interface (UEFI) and from the Intel Framework specifications to the UEFI Platform Initialization (PI) specifications. Note the omission of the word “Framework” from the title of the present volume. Some of the changes that have occurred since the first edition of this book include the migration of much of the Intel Framework specification content into the five volumes of the UEFI Platform Initialization (PI) specifications, which are presently at revision 1.2 and can be found at the Web site www.uefi.org. In addition to the PI evolution from Framework, additional capabilities have evolved in both the PI building-block specifications and in the UEFI specification. The UEFI specification itself has evolved to revision 2.3 in the time since the first edition of this text, as well.

When we discuss UEFI, we need to emphasize that UEFI is a pure interface specification that does not dictate how the platform firmware is built; the “how” is relegated to PI. The consumers of UEFI include but are not limited to operating system loaders, installers, adapter ROMs from boot devices, pre-OS diagnostics, utilities, and OS runtimes (for the small set of UEFI runtime services). In general, though, UEFI is about *booting*, or passing control to a successive layer of control, namely an operating system loader, as shown in Figure 1.1. UEFI offers many interesting capabilities and can exist

as a limited runtime for some application set, in lieu of loading a full, shrink-wrapped multi-address space operating system like Microsoft Windows[†], Apple OS X[†], HP-UX[†], or Linux, but that is not the primary design goal.

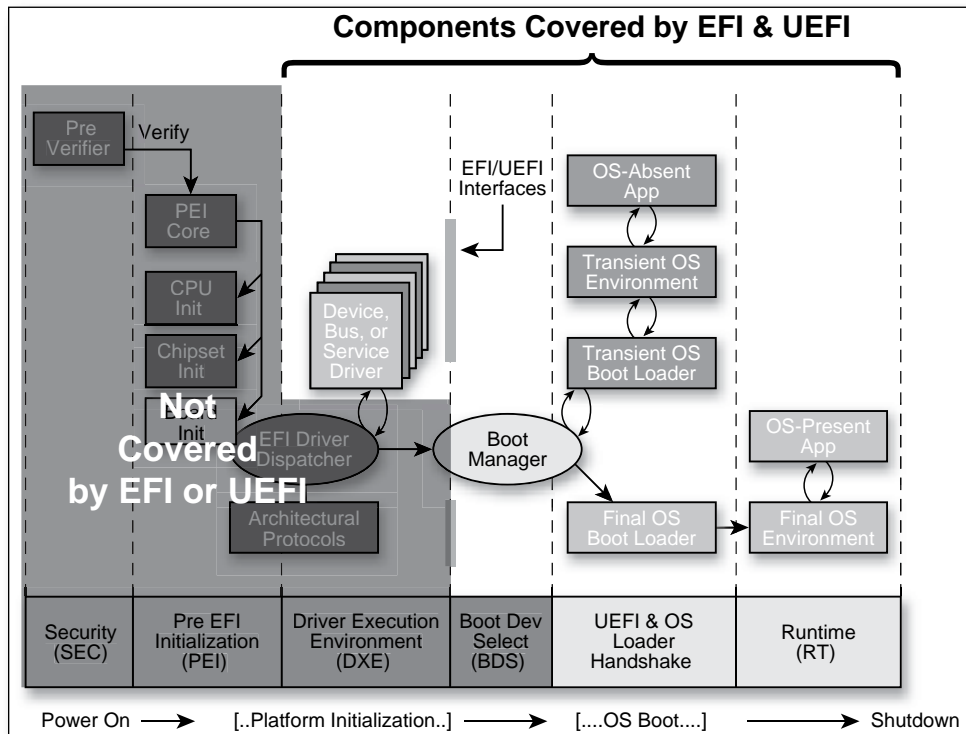

Figure 1.1 Where EFI and UEFI Fit into the Platform Boot Flow

PI, on the other hand, should be largely opaque to the pre-OS boot devices, operating systems, and their loaders since it covers many software aspects of platform construction that are irrelevant to those consumers. PI instead describes the phases of control from the platform reset and into the success phase of operation, including an environment compatible with UEFI, as shown in Figure 1.2. In fact, the PI DXE component is the preferred UEFI core implementation.

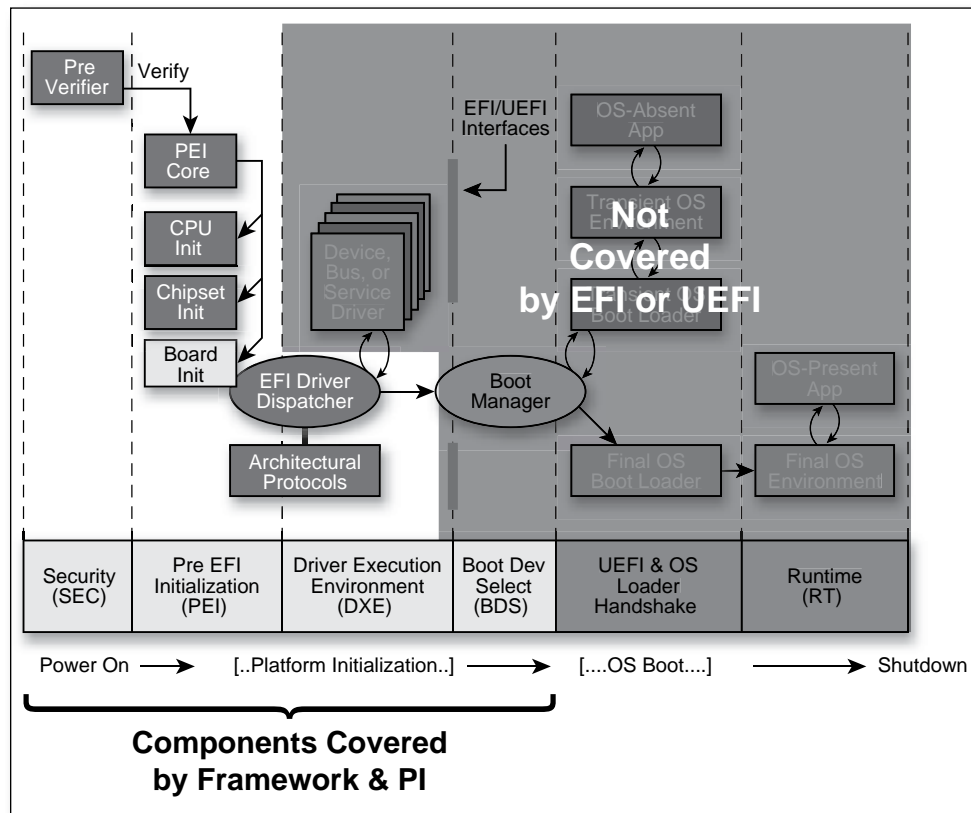

Figure 1.2 Where PI and Framework Fit into the Platform Boot Flow

Within the evolution of Framework to PI, some things were omitted from inclusion in the PI specifications. As a result of these omissions, some subjects that were discussed in the first edition of *Beyond BIOS*, such as the compatibility support module (CSM), have been removed from the second edition in order to provide space to describe the newer PI and UEFI capabilities. This omission is both from a scope perspective, namely that the PI specification didn't want to codify or include the CSM, but also from a long-term perspective. Specifically, the CSM specification abstracted booting on a PC/AT system. This requires an x86 processor, PC/AT hardware complex (for example, 8254, 8259, RTC). The CSM also inherited other conventional BIOS boot limitations, such as the 2.2-TB disk limit of Master Boot Record (MBR) partition tables. For a world of PI and UEFI, you get all of the x86 capabilities (IA-32 and x64,

respectively), ARM[†], Itanium[®], and future CPU bindings. Also, via the polled driver model design, UEFI APIs, and the PI DXE architectural protocols, the platform and component hardware details are abstracted from all consumer software. Other minor omissions also include data hub support. The latter has been replaced by purpose-built infrastructure to fill the role of data hub in Framework-based implementations, such as SMBIOS table creation and agents to log report status code actions.

What has happened in PI beyond Framework, though, includes the addition of a multiprocessor protocol, Itanium E-SAL and MCA support, the above-listed report-status code listener and SMBIOS protocol, an ACPI editing protocol, and an SIO protocol. With Framework collateral that moved to PI, a significant update was made to the System Management Mode (SMM) protocol and infrastructure to abstract out various CPU and chipset implementations from the more generic components. On the DXE front, small cleanup was added in consideration of UEFI 2.3 incompatibility. Some additions occurred in the PEI foundation for the latest evolution in buses, such as PCI Express[†]. In all of these cases, the revisions of the SMM, PEI, and DXE service tables were adjusted to ease migration of any SMM drivers, DXE drivers, and PEI module (PEIM) sources to PI. In the case of the firmware file system and volumes, the headers were expanded to comprehend larger file and alternate file system encodings, respectively. Unlike the case for SMM drivers, PEIMs, and DXE drivers, these present a new binary encoding that isn't compatible with a pure Framework implementation.

The notable aspect of the PI is the participation of the various members of the UEFI Forum, which will be described below. These participants represent the consumers and producers of PI technology. The ultimate consumer of a PI component is the vendor shipping a system board, including multinational companies such as Apple, Dell, HP, IBM, Lenovo, and many others. The producers of PI components include generic infrastructure producers such as the independent BIOS vendors (IBVs) like AMI, Insyde, Phoenix, and others. And finally, the vendors producing chipsets, CPUs, and other hardware devices like AMD, ARM, and Intel would produce drivers for their respective hardware. The IBVs and the OEMs would use the silicon drivers, for example. If it were not for this business-to-business transaction, the discoverable binary interfaces and separate executable modules (such as PEIMs and DXE drivers) would not be of interest. This is especially true since publishing GUID-based APIs, marshalling interfaces, discovering and dispatching code, and so on take some

overhead in system board ROM storage and boot time. Given that there's never enough ROM space, and also in light of the customer requirements for boot-time such as the need to be “instantly on,” this overhead must be balanced by the business value of PI module enabling. If only one vendor had access to all of the source and intellectual property to construct a platform, a statically bound implementation would be more efficient, for example. But in the twenty-first century with the various hardware and software participants in the computing industry, software technology such as PI is key to getting business done in light of the ever-shrinking resource and time-to-market constraints facing all of the UEFI forum members.

There is a large body of Framework-based source-code implementations, such as those derived or dependent upon EDK I (EFI Developer Kit version 1), which can be found on www.tianocore.org. These software artifacts can be recompiled into a UEFI 2.3, PI 1.2-compliant core, such as UDK2010 (the UEFI Developer Kit revision 2010), via the EDK Compatibility Package (ECP). For new development, though, the recommendation is to build native PI 1.2, UEFI 2.3 modules in the UDK2010 since these are the specifications against which long-term silicon enabling and operating system support will occur, respectively.

Terminology

The following list provides a quick overview of some of the terms that may be encountered later in the book and have existed in the industry associated with the BIOS standardization efforts.

- *UEFI Forum.* The industry body which produces UEFI, Platform Initialization (PI), and other specifications.
- *UEFI Specification.* The firmware-OS interface specification.
- *EDK.* The EFI Development Kit, an open sourced project that provides a basic implementation of UEFI, Framework, and other industry standards. It is not however, a complete BIOS solution. An example of this can be found at www.tianocore.org.

- *UDK*. The UEFI Development Kit is the second generation of the EDK (EDK II), which has added a variety of codebase related capabilities and enhancements. The inaugural UDK is UDK2010, with the number designating the instance of the release.
- *Framework*. A deprecated term for a set of specifications that define interfaces and how various platform components work together. What this term referred to is now effectively replaced by the PI specifications.
- *Tiano*. An obsolete codename for an Intel codebase that implemented the Framework specifications.

A Short History of EFI

The Extensible Firmware interface (EFI) project was developed by Intel, with the initial specification released in 1999. At the time, it was designed as the means by which to boot Itanium-based systems. The original proposal for booting Itanium was the SAL (System Architectural Layer) SAL_PROC interface, with an encapsulation of the PC/AT BIOS registers as the arguments and parameters. Specifically, the means to access the disk in the SAL_PROC proposal was “SAL_PROC (0x13, 0x2, ...)”, which is aligned with the PC/AT conventional BIOS call of “int13h.”

Given the opportunity to clean up the boot interface, various proposals were provided. These included but were not limited to Open Firmware and Advanced RISC Computing (ARC). Ultimately, though, EFI prevailed and its architecture-neutral interface was adopted.

The initial EFI specification included both an Itanium and IA-32 binding. EFI evolved from the EFI 1.02 interface into EFI1.10 in 2001. EFI1.10 introduced the EFI Driver model.

With the advent of 64-bit computing on IA-32 (for example, x64) and the industry’s need to have a commonly owned specification, the UEFI 2.0 specification appeared in 2005. UEFI 2.0 is largely the same as EFI 1.0, but also included the modular networking stack APIs for IPv4 and the x64 binding.

In Figure 1.3 we illustrate the evolution of the BIOS from its legacy days through 2010.

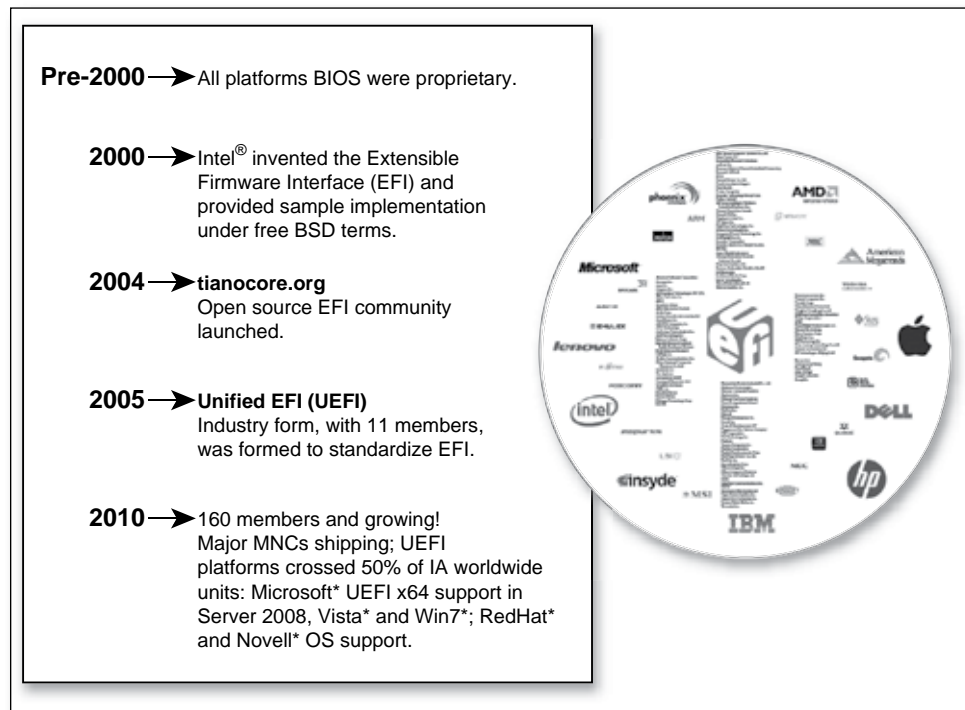

Figure 1.3 BIOS Evolution Timeline

EFI Becomes UEFI—The UEFI Forum

Regarding the UEFI Forum, there are various aspects to how it manages both the UEFI and PI specifications. Specifically, the UEFI forum is responsible for creating the UEFI and PI specifications.

When the UEFI Forum first formed, a variety of factors and steps were part of the creation process of the first specification:

- The UEFI forum stakeholders agree on EFI direction
- Industry commitment drives need for broader governance on specification
- Intel and Microsoft contribute seed material for updated specification

- EFI 1.10 components provide starting drafts

- Intel agrees to contribute EFI test suite

As this had established the framework of the specification material that was produced which the industry used, the forum itself was formed with several thoughts in mind:

- The UEFI Forum is established as a Washington non-profit Corporation

- Develops, promotes and manages evolution of Unified EFI Specification
- Continue to drive low barrier for adoption

- The Promoter members for the UEFI forum are:

- AMD, AMI, Apple, Dell, HP, IBM, Insyde, Intel, Lenovo, Microsoft, Phoenix

- The UEFI Forum has a form of tiered Membership:

- Promoters, Contributors and Adopters
- More information on the membership tiers can be found at: www.uefi.org

- The UEFI Forum has several work groups:

- Figure 1.4 illustrates the basic makeup of the forum and the corresponding roles.

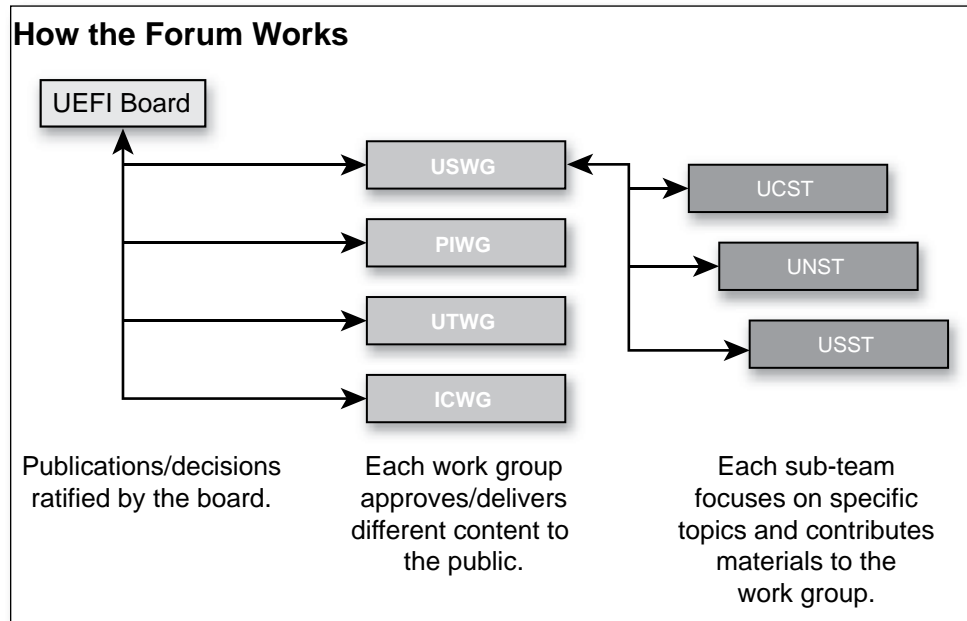

Figure 1.4 Forum group hierarchy

- Sub-teams are created in the main owning workgroup when a topic of sufficient depth requires a lot of discussion with interested parties or experts in a particular domain. These teams are collaborations amongst many companies who are responsible for addressing the topic in question and bringing back to the work-group either a response or material for purposes of inclusion in the main working specification. Some examples of sub-teams that have been created are as follows as of this book publication:

- UCST – UEFI Configuration Sub-team
 - Chaired by Michael Rothman (Intel)
 - Responsible for all configuration related material and the team has been responsible for the creation of the UEFI configuration infrastructure commonly known as HII, which is in the UEFI Specification.

- UNST – UEFI Networking Sub-team
 - Chaired by Vincent Zimmer (Intel)
 - Responsible for all network related material and the team has been responsible for the update/inclusion of the network related material in the UEFI specification, most notably the IPv6 network infrastructure.
- USST – UEFI Security Sub-team
 - Chaired by Tim Lewis (Phoenix)
 - Responsible for all security related material and the team has been responsible for the added security infrastructure in the UEFI specification.

PIWG and USWG

The Platform Initialization Working Group (PIWG) is the portion of the UEFI forum that defines the various specifications in the PI corpus. The UEFI Specification Working Group (USWG) is the group that evolves the main UEFI specification. Figure 1.5 illustrates the layers of the platform and what the scope that the USWG and PIWG cover.

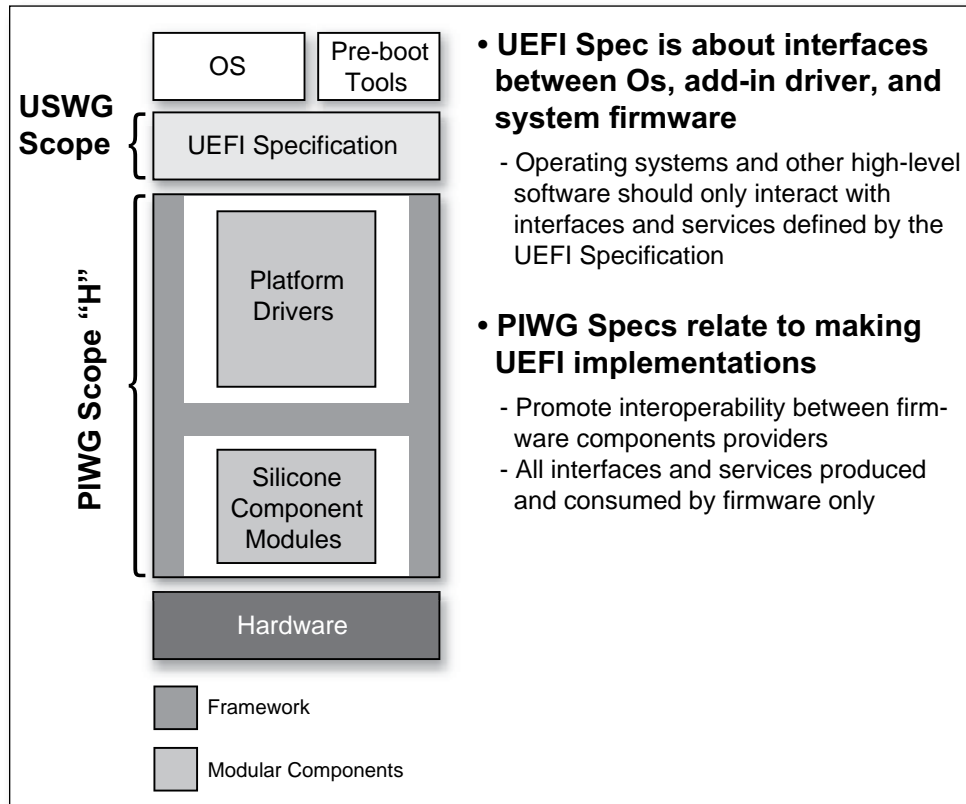

Figure 1.5 PI/UEFI layering

Over time, these specifications have evolved. Below we enumerate the recent history of specifications and the work associated with each:

■ UEFI 2.1

- Roughly one year of Specification work
 - Builds on UEFI 2.0
- New content area highlights:
 - Human Interface Infrastructure
 - Hardware Error Record Support
 - Authenticated Variable Support

- Simple Text Input Extensions
- Absolute Pointer Support
- UEFI 2.2
 - Follow-on material from existing 2.1 content
 - Backlog that needed more gestation time
 - Security/Integrity related enhancements
 - Provide service interfaces for UEFI drivers that want to operate with high integrity implementations of UEFI
 - Human Interface Infrastructure enhancements
 - Further enhancements pending to help interaction/configuration of platforms with standards-based methodologies.
 - Networking
 - IPv6, PXE+, IPsec
 - Various other subject areas possible
 - More boot devices, more authentication support, more networking updates, etc.
- UEFI2.3
 - ARM binding
 - Firmware management protocol

To complement the layering picture in Figure 1.5, Figure 1.6 shows how the PI elements evolve into the UEFI. The left half of the diagram with SEC, PEI, and DXE are described by the PI specifications. BDS, UEFI+OS Loader handshake, and RT are the province of the UEFI specification.

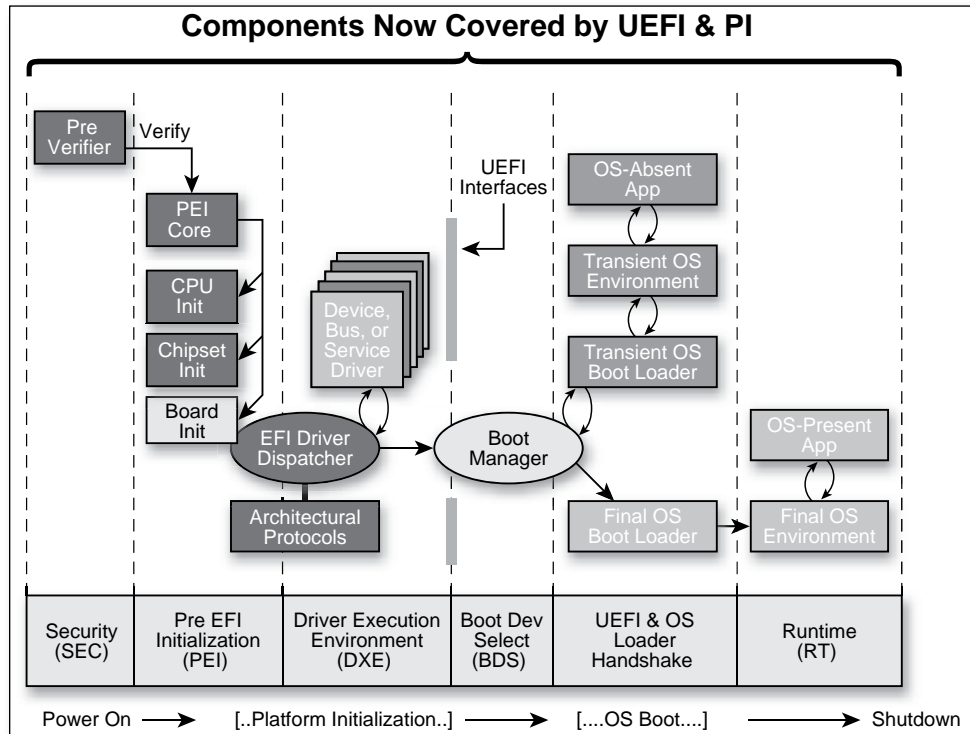

Figure 1.6 Where PI and Framework Fit into the Platform Boot Flow

In addition, as time has elapsed, the specifications have evolved. Figure 1.7 is a time line for the specifications and the implementations associated with them.

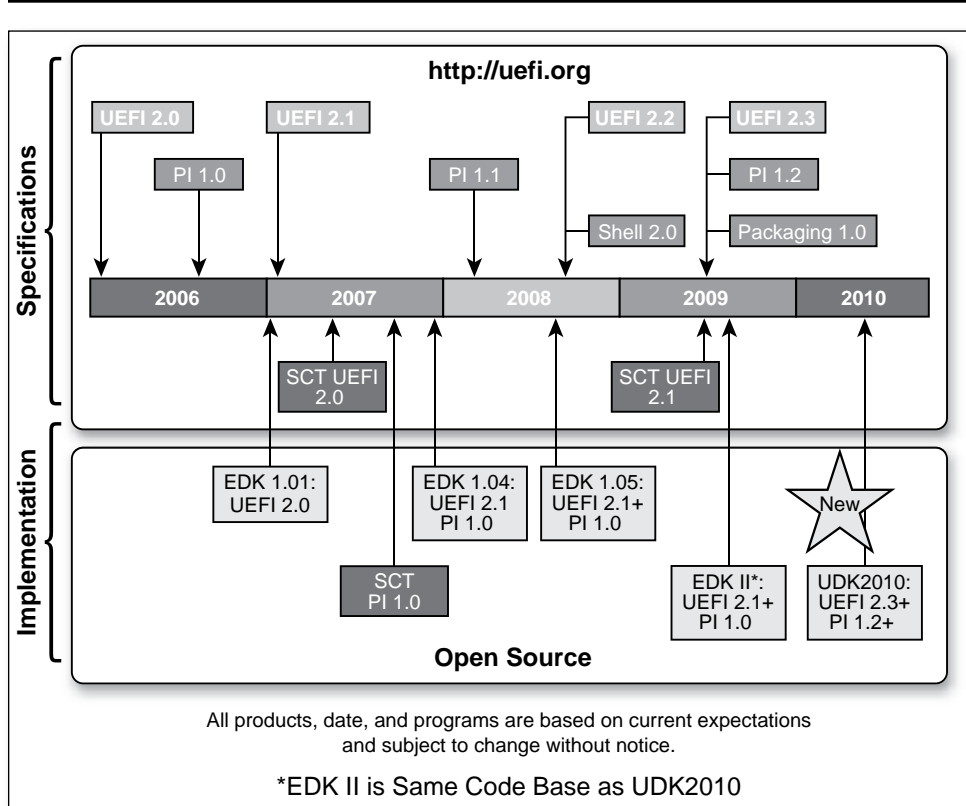

Figure 1.7 Specification and Codebase Timeline

Platform Trust/Security

Recall that PI allowed for business-to-business engagements between component providers and system builders. UEFI, on the other hand, has a broader set of participants. These include the operating system vendors that built the OS installers and UEFI-based runtimes; BIOS vendors who provide UEFI implementations; platform manufacturers, such as multi-national corporations who ship UEFI-compliant boards; independent software vendors who create UEFI applications and diagnostics; independent hardware vendors who create drivers for their adapter cards; and platform owners, whether a home PC user or corporate IT, who must administer the UEFI-based system.

PI differs from UEFI in the sense that the PI components are delivered under the authority of the platform manufacturer and are not typically extensible by third parties. UEFI, on the other hand, has a mutable file system partition, boot variables, a driver load list, support of discoverable option ROMs in host-bus adapters (HBAs), and so on. As such, PI and UEFI offer different issues with respect to security. Chapter 10 treats this topic in more detail, but in general, the security dimension of the respective domains include the following: PI must ensure that the PI elements are only updateable by the platform manufacturer, recovery, and PI is a secure implementation of UEFI features, including security; UEFI provides infrastructure to authenticate the user, validate the source and integrity of UEFI executables, network authentication and transport security, audit (including hardware-based measured boot), and administrative controls across UEFI policy objects, including write-protected UEFI variables.

A fusion of these security elements in a PI implementation is shown in Figure 1.8.

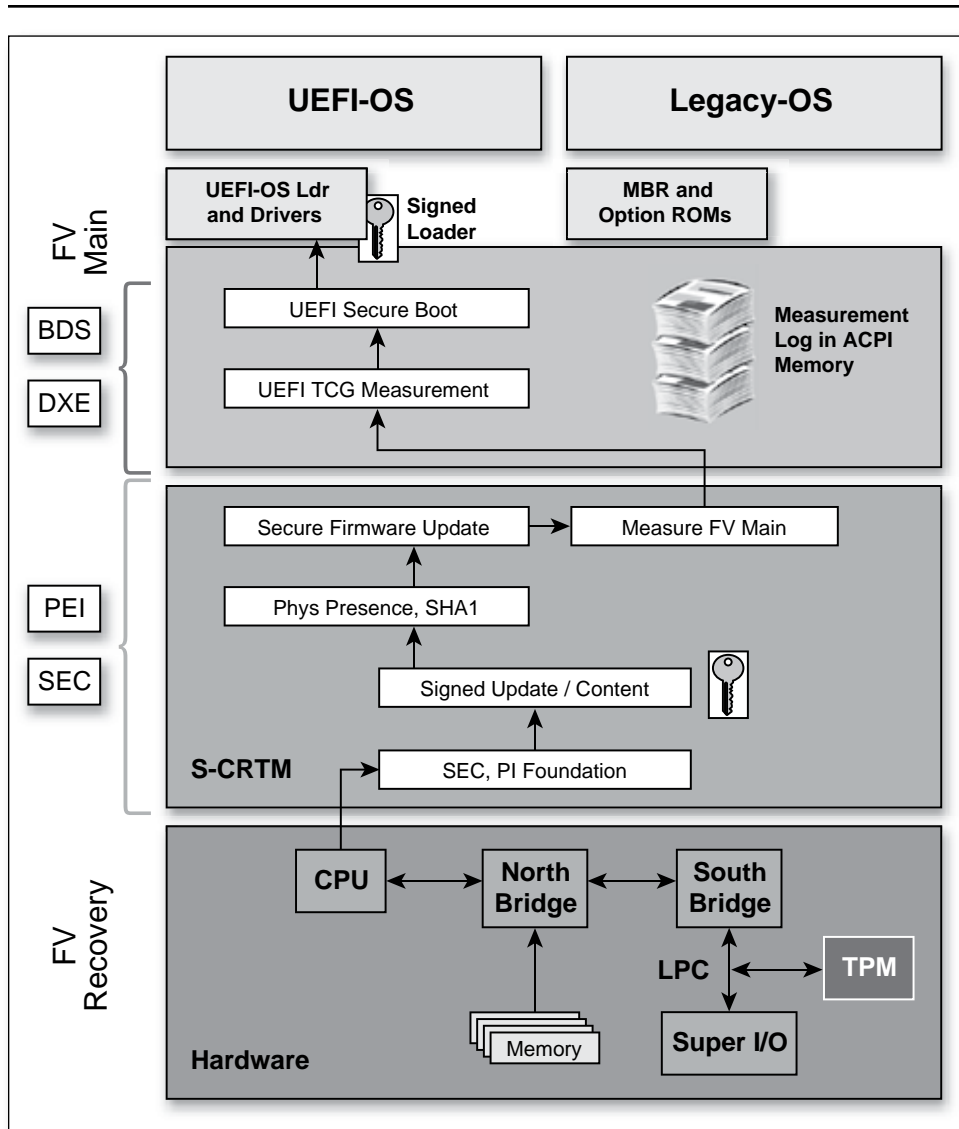

Figure 1.8 Trusted UEFI/PI stack

Embedded Systems: The New Challenge

As the UEFI took off and became pervasive, a new challenge has been taking shape in the form of the PC platform evolution to take on the embedded devices, more specifically the consumer electronic devices, with a completely different set of requirements driven by user experience factors like instant power-on for various embedded operating systems. Many of these operating systems required customized firmware with OS-specific firmware interfaces and did not fit well into the PC firmware ecosystem model.

The challenge now is to make the embedded platform firmware have similar capabilities to the traditional model such as the being OS-agnostic, being scalable across different platform hardware, and being able to lessen the development time to port and to leverage the UEFI standards.

How the Boot Process Differs between a Normal Boot and an Optimized/Embedded Boot

Figure 1.9 indicates that between the normal boot and an optimized boot, there are no design differences from a UEFI architecture point of view. Optimizing a platform's performance does *not* mean that one has to violate any of the design specifications. It should also be noted that to comply with UEFI, one does not need to encompass all of the standard PC architecture, but instead the design can limit itself to the components that are necessary for the initialization of the platform itself. Chapter 2 in the *UEFI 2.3 specification* does enumerate the various components and conditions that comprise UEFI compliance.

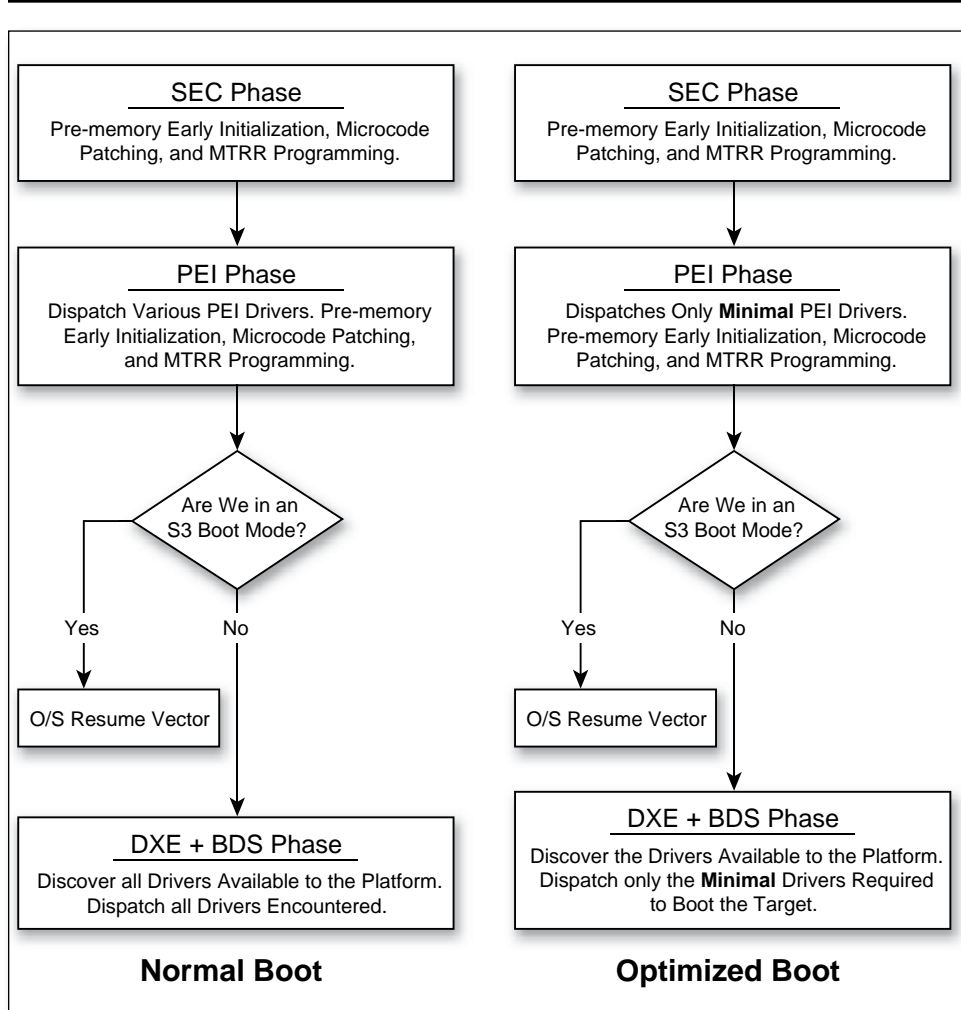

Figure 1.9 Architectural Boot Flow Comparison



Summary

We have provided some rationale in this chapter for the changes from *Beyond BIOS: Implementing the Unified Extensible Firmware Interface with Intel's Framework* to *Beyond BIOS: Developing with the Unified Extensible Firmware Interface*. These elements include the industry members' ownership and governance of the UEFI specification. Beyond this sea change, the chapter describes the migration of the Framework specifications to PI specification and the evolution of PI over the former Framework feature set. In addition, the section describes the evolution of the UEFI specification to UEFI 2.3 from the initial UEFI 2.0 matter in the first edition. Finally, some of the codebase technology to help realize implementations of this technology was discussed.

So fasten your seat belt and dive into a journey through industry standard firmware.

Chapter 2

Basic UEFI Architecture

I believe in standards. Everyone should have one.

—George Morrow

The Unified Extensible Firmware Interface (UEFI) describes a programmatic interface to the platform. The platform includes the motherboard, chipset, central processing unit (CPU), and other components. UEFI allows for pre-operating system (pre-OS) agents. Pre-OS agents are OS loaders, diagnostics, and other applications that the system needs for applications to execute and interoperate, including UEFI drivers and applications. UEFI represents a pure interface specification against which the drivers and applications interact, and this chapter highlights some of the architectural aspects of the interface. These architectural aspects include a set of objects and interfaces described by the UEFI Specification.

The cornerstones for understanding UEFI applications and drivers are several UEFI concepts that are defined in the *UEFI 2.3 Specification*. Assuming you are new to UEFI, the following introduction explains a few of the key UEFI concepts in a helpful framework to keep in mind as you study the specification:

- Objects managed by UEFI-based firmware - used to manage system state, including I/O devices, memory, and events.

- The UEFI System Table - the primary data structure with data information tables and function calls to interface with the systems.
- Handle database and protocols - the means by which callable interfaces are registered.
- UEFI images - the executable content format by which code is deployed.
- Events - the means by which software can be signaled in response to some other activity.
- Device paths - a data structure that describes the hardware location of an entity, such as the bus, spindle, partition, and file name of a UEFI image on a formatted disk.

Objects Managed by UEFI-based Firmware

Several different types of objects can be managed through the services provided by UEFI. Some UEFI drivers may need to access environment variables, but most do not. Rarely do UEFI drivers require the use of a monotonic counter, watchdog timer, or real-time clock. The UEFI System Table is the most important data structure, because it provides access to all UEFI-provided the services and to all the additional data structures that describe the configuration of the platform.

UEFI System Table

The UEFI System Table is the most important data structure in UEFI. A pointer to the UEFI System Table is passed into each driver and application as part of its entry-point handoff. From this one data structure, a UEFI executable image can gain access to system configuration information and a rich collection of UEFI services that includes the following:

- UEFI Boot Services

- UEFI Runtime Services

- Protocol services

The UEFI Boot Services and UEFI Runtime Services are accessed through the UEFI Boot Services Table and the UEFI Runtime Services Table, respectively. Both of these tables are data fields in the UEFI System Table. The number and type of services that each table makes available is fixed for each revision of the UEFI specification. The UEFI Boot Services and UEFI Runtime Services are defined in the *UEFI 2.3 Specification*.

Protocol services are groups of related functions and data fields that are named by a Globally Unique Identifier (GUID), a 16-byte, statistically-unique entity defined in Appendix A of the *UEFI 2.3 Specification*. Typically, protocol services are used to provide software abstractions for devices such as consoles, disks, and networks, but they can be used to extend the number of generic services that are available in the platform. Protocols are the mechanism for extending the functionality of UEFI firmware over time. The *UEFI 2.3 Specification* defines over 30 different protocols, and various implementations of UEFI firmware and UEFI drivers may produce additional protocols to extend the functionality of a platform.

Handle Database

The *handle database* is composed of objects called handles and protocols. *Handles* are a collection of one or more protocols, and *protocols* are data structures that are named by a GUID. The data structure for a protocol may be empty, may contain data fields, may contain services, or may contain both services and data fields. During UEFI initialization, the system firmware, UEFI drivers, and UEFI applications create handles and attach one or more protocols to the handles. Information in the handle database is global and can be accessed by any executable UEFI image.

The handle database is the central repository for the objects that are maintained by UEFI-based firmware. The handle database is a list of UEFI handles, and each UEFI handle is identified by a unique handle number that is maintained by the system firmware. A handle number provides a database “key” to an entry in the handle database. Each entry in the handle database is a collection of one or more protocols. The types of protocols, named by a

GUID, that are attached to a UEFI handle determine the handle type. A UEFI handle may represent components such as the following:

- Executable images such as UEFI drivers and UEFI applications
- Devices such as network controllers and hard drive partitions
- UEFI services such as UEFI Decompression and the EBC Virtual Machine

Figure 2.1 below shows a portion of the handle database. In addition to the handles and protocols, a list of objects is associated with each protocol. This list is used to track which agents are consuming which protocols. This information is critical to the operation of UEFI drivers, because this information is what allows UEFI drivers to be safely loaded, started, stopped, and unloaded without any resource conflicts.

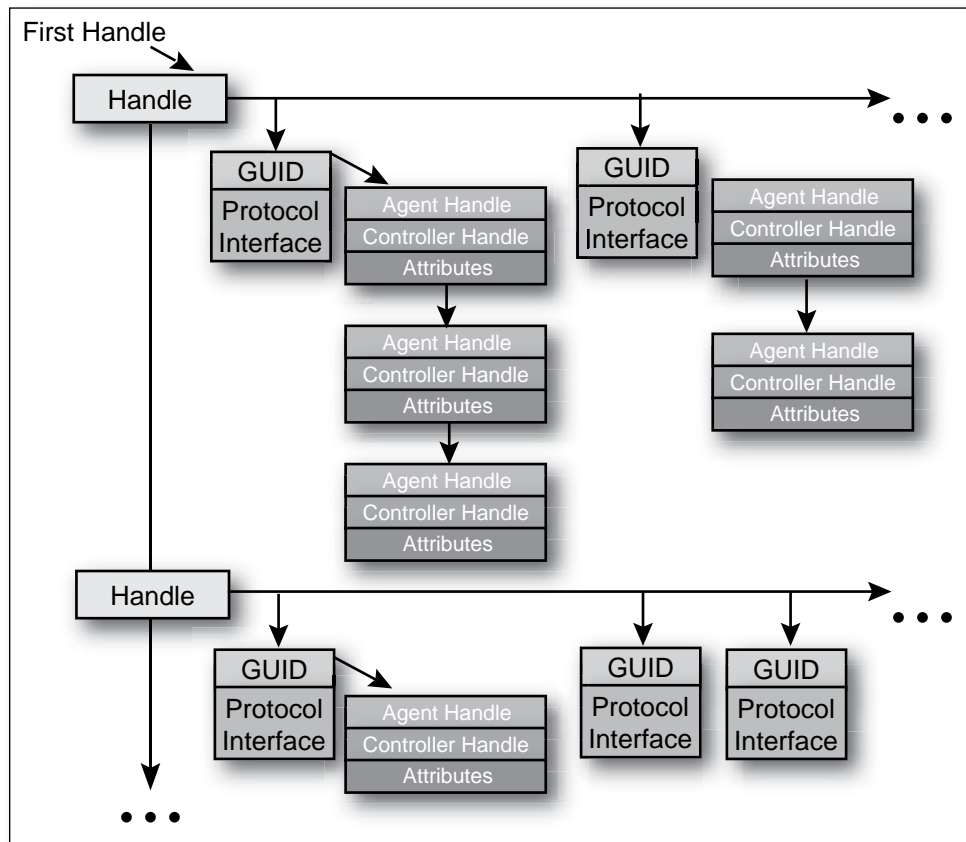

Figure 2.1 Handle Database

Figure 2.2 shows the different types of handles that can be present in the handle database and the relationships between the various handle types. All handles reside in the same handle database and the types of protocols that are associated with each handle differentiate the handle type. Like file system handles in an operating system context, the handles are unique for the session, but the values can be arbitrary. Also, like the handle returned from an `fopen` function in a C library, the value does not necessarily serve a useful purpose in a different process or during a subsequent restart in the same process. The handle is just a transitory value to manage state.

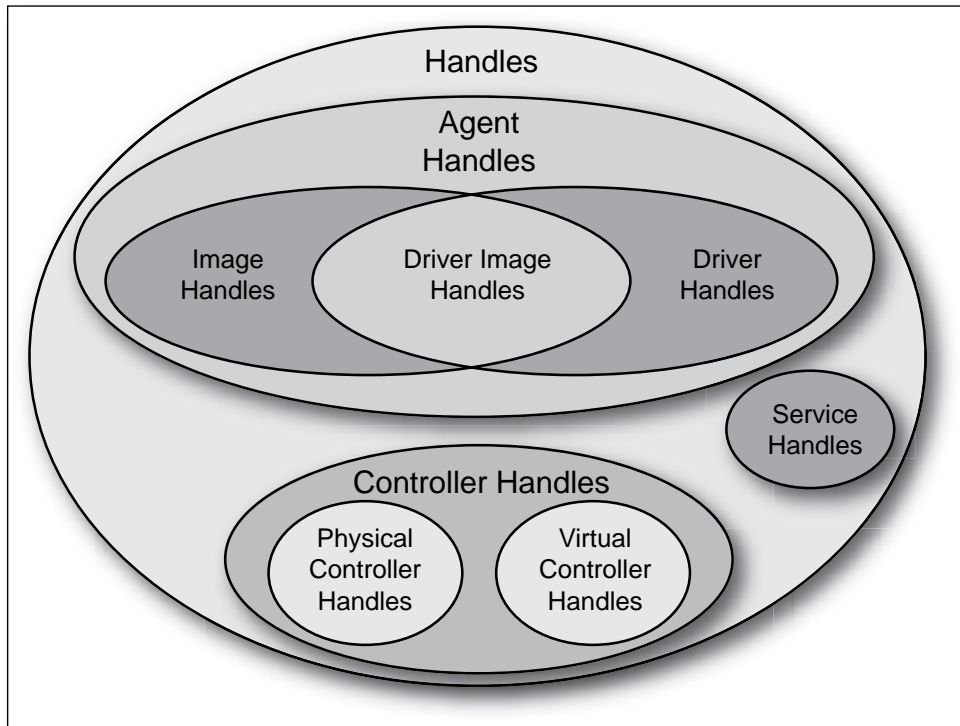

Figure 2.2 Handle Types

Protocols

The extensible nature of UEFI is built, to a large degree, around protocols. UEFI drivers are sometimes confused with UEFI protocols. Although they are closely related, they are distinctly different. A *UEFI driver* is an executable UEFI image that installs a variety of protocols of various handles to accomplish its job.

A *UEFI protocol* is a block of function pointers and data structures or APIs that have been defined by a specification. At a minimum, the specification must define a GUID. This number is the protocol's real name; boot services like `LocateProtocol` uses this number to find his protocol in the handle database. The protocol often includes a set of procedures and/or data structures, called

the *protocol interface structure*. The following code sequence is an example of a protocol definition. Notice how it defines two function definitions and one data field.

Sample GUID

```
#define EFI_COMPONENT_NAME2_PROTOCOL_GUID \
{0x6a7a5cff, 0xe8d9, 0x4f70, 0xba, 0xda, 0x75, 0xab, 0x30,
0x25, 0xce, 0x14}
```

Protocol Interface Structure

```
typedef struct _EFI_COMPONENT_NAME2_PROTOCOL {
    EFI_COMPONENT_NAME_GET_DRIVER_NAME
    GetDriverName;
    EFI_COMPONENT_NAME_GET_CONTROLLER_NAME
    GetControllerName;
    CHAR8
    *SupportedLanguages;
} EFI_COMPONENT_NAME2_PROTOCOL;
```

Figure 2.3 shows a single handle and protocol from the handle database that is produced by a UEFI driver. The protocol is composed of a GUID and a protocol interface structure. Many times, the UEFI driver that produces a protocol interface maintains additional private data fields. The protocol interface structure itself simply contains pointers to the protocol function. The protocol functions are actually contained within the UEFI driver. A UEFI driver might produce one protocol or many protocols depending on the driver's complexity.

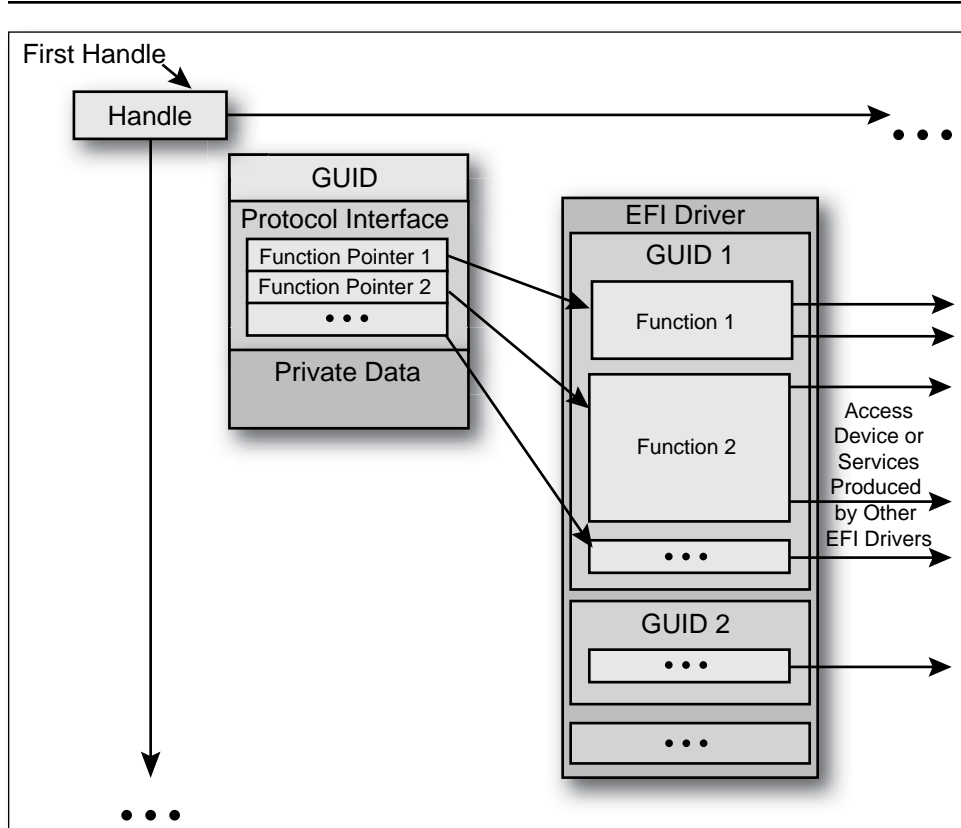

Figure 2.3 Construction of a Protocol

Not all protocols are defined in the *UEFI 2.3 Specification*. The UEFI Developer Kit 2010 (UDK2010) includes many protocols that are not part of the *UEFI 2.3 Specification*. This project can be found at <http://www.tianocore.org>. These protocols provide the wider range of functionality that might be needed in any particular implementation, but they are not defined in the *UEFI 2.3 Specification* because they do not present an external interface that is required to support booting an OS or writing a UEFI driver. The creation of new protocols is how UEFI-based systems can be extended over time as new devices, buses, and technologies are introduced. For example, some protocols that are in the *EDK II* but not in the *UEFI 2.3 Specification* are:

- Varstore – interface to abstract storage of UEFI persistent binary objects

- ConIn – service to provide a character console input
- ConOut – service to provide a character console output
- StdErr – service to provide a character console output for error messaging
- PrimaryConIn – the console input with primary view
- VgaMiniPort – a service that provides Video Graphics Array output
- UsbAtapi – a service to abstract block access on USB bus

The UEFI Application Toolkit also contains a number of UEFI protocols that may be found on some platforms, such as:

- PPP Daemon – Point-to-Point Protocol driver
- Ramdisk – file system instance on a Random Access Memory buffer
- TCP/IP – Transmission Control Protocol / Internet Protocol
- The Trusted Computing Group interface and platform specification, such as:
 - EFI TCG Protocol – interaction with a Trusted Platform Module (TPM).

The OS loader and drivers should not depend on these types of protocols because they are not guaranteed to be present in every UEFI-compliant system. OS loaders and drivers should depend only on protocols that are defined in the *UEFI2.3 Specification* and protocols that are required by platform design guides such as *Design Implementation Guide for 64-bit Server*.

The extensible nature of UEFI allows the developers of each platform to design and add special protocols. Using these protocols, they can expand the capabilities of UEFI and provide access to proprietary devices and interfaces in congruity with the rest of the UEFI architecture.

Because a protocol is “named” by a GUID, no other protocols should have that same identification number. Care must be taken when creating a new protocol to define a new GUID for it. UEFI fundamentally assumes that a

specific GUID exposes a specific protocol interface. Cutting and pasting an existing GUID or hand-modifying an existing GUID creates the opportunity for a duplicate GUID to be introduced. A system containing a duplicate GUID inadvertently could find the new protocol and think that it is another protocol, crashing the system as a result. For these types of bugs, finding the root cause is also very difficult. The GUID allows for naming APIs without having to worry about namespace collision. In systems such as PC/AT BIOS, services were added as an enumeration. For example, the venerable `Int15h` interface would pass the service type in `AX`. Since no central repository or specification managed the evolution of `Int15h` services, several vendors defined similar service numbers, thus making interoperability with operating systems and pre-OS applications difficult. Through the judicious use of GUIDs to name APIs and an association to develop the specification, UEFI balances the need for API evolution with interoperability.

Working with Protocols

Any UEFI code can operate with protocols during boot time. However, after `ExitBootServices()` is called, the handle database is no longer available. Several UEFI boot time services work with UEFI protocols.

Multiple Protocol Instances

A handle may have many protocols attached to it. However, it may have only one protocol of each type. In other words, a handle may not have more than one instance of the exact same protocol. Otherwise, it would make requests for a particular protocol on a handle nondeterministic.

However, drivers may create multiple instances of a particular protocol and attach each instance to a different handle. The PCI I/O Protocol fits this scenario, where the PCI bus driver installs a PCI I/O Protocol instance for each PCI device. Each instance of the PCI I/O Protocol is configured with data values that are unique to that PCI device, including the location and size of the UEFI Option ROM (OpROM) image.

Also, each driver can install customized versions of the same protocol as long as they do not use the same handle. For example, each UEFI driver installs the Component Name Protocol on its driver image handle, yet when the `EFI_COMPONENT_NAME2_PROTOCOL.GetDriverName()`

function is called, each handle returns the unique name of the driver that owns that image handle. The `EFI_COMPONENT_NAME2_PROTOCOL.GetDriverName()` function on the USB bus driver handle returns “USB bus driver” for the English language, but on the PXE driver handle it returns “PXE base code driver.”

Tag GUID

A protocol may be nothing more than a GUID. In such cases, the GUID is called a *tag GUID*. Such protocols can serve useful purposes such as marking a device handle as special in some way or allowing other UEFI images to easily find the device handle by querying the system for the device handles with that protocol GUID attached. The *EDKII* uses the `HOT_PLUG_DEVICE_GUID` in this way to mark device handles that represent devices from a hot-plug bus such as USB.

UEFI Images

All UEFI images contain a PE/COFF header that defines the format of the executable code as required by the *Microsoft Portable Executable and Common Object File Format Specification* (Microsoft 2008). The target for this code can be an IA-32 processor, an Itanium® processor, x64, ARM, or a processor agnostic, generic EFI Byte Code (EBC). The header defines the processor type and the image type. Presently there are three processor types and the following three image types defined:

- UEFI applications – images that have their memory and state reclaimed upon exit.
- UEFI Boot Service drivers – images that have their memory and state preserved throughout the pre-operating system flow. Their memory is reclaimed upon invocation of `ExitBootServices()` by the OS loader.
- UEFI Runtime drivers – images whose memory and state persist throughout the evolution of the machine. These images coexist with and can be invoked by a UEFI-aware operating system.

The value of the UEFI Image format is that various parties can create binary executables that interoperate. For example, the operating system loader for Microsoft Windows[†] and Linux for a UEFI-aware OS build is simply a UEFI application. In addition, third parties can create UEFI drivers to abstract their particular hardware, such as a networking interface host bus adapter (HBA) or other device. UEFI images are loaded and relocated into memory with the Boot Service `gBS >LoadImage()`. Several supported storage locations for UEFI images are available, including the following:

- Expansion ROMs on a PCI card
- System ROM or system flash
- A media device such as a hard disk, floppy, CD-ROM, or DVD
- A LAN boot server

In general, UEFI images are not compiled and linked at a specific address. Instead, the UEFI image contains relocation fix-ups so the UEFI image can be placed anywhere in system memory. The Boot Service `gBS >LoadImage()` does the following:

- Allocates memory for the image being loaded
- Automatically applies the relocation fix-ups to the image
- Creates a new image handle in the handle database, which installs an instance of the `EFI_LOADED_IMAGE_PROTOCOL`

This instance of the `EFI_LOADED_IMAGE_PROTOCOL` contains information about the UEFI image that was loaded. Because this information is published in the handle database, it is available to all UEFI components.

After a UEFI image is loaded with `gBS >LoadImage()`, it can be started with a call to `gBS >StartImage()`. The header for a UEFI image contains the address of the entry point that is called by `gBS >StartImage()`. The entry point always receives the following two parameters:

- The image handle of the UEFI image being started
- A pointer to the UEFI System Table

These two items allow the UEFI image to do the following:

- Access all of the UEFI services that are available in the platform.
- Retrieve information about where the UEFI image was loaded from and where in memory the image was placed.

The operations that the UEFI image performs in its entry point vary depending on the type of UEFI image. Figure 2.4 shows the various UEFI image types and the relationships between the different levels of images.

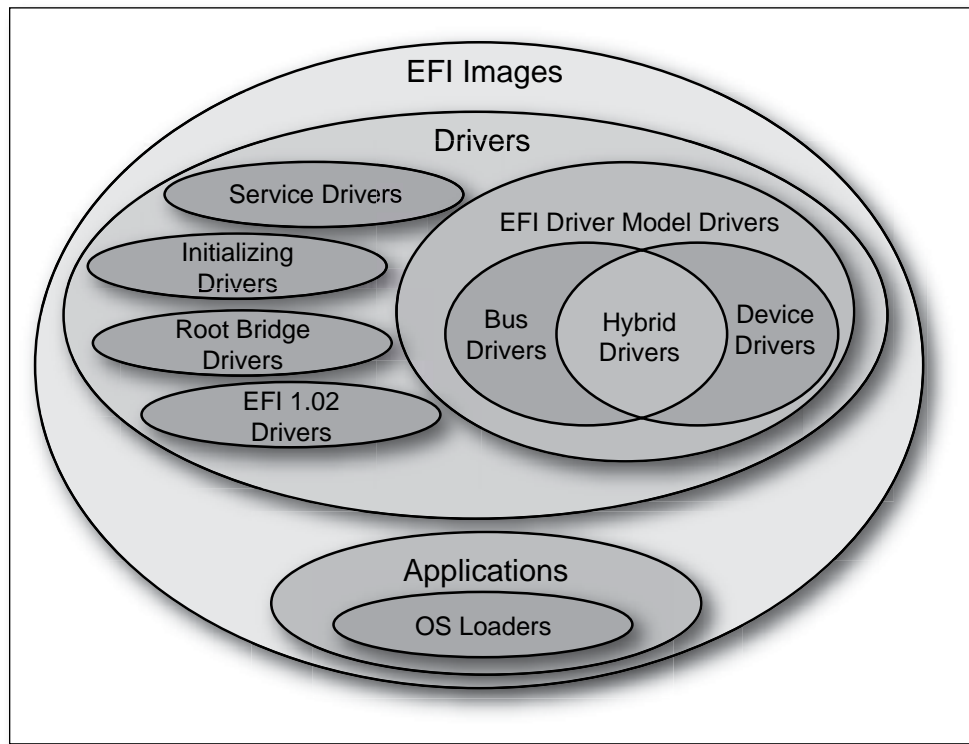

Figure 2.4 Image Types and Their Relationship to One Another

Table 2.1 Description of Image Types

Type of Image	Description
Application	A UEFI image of type <code>EFI_IMAGE_SUBSYSTEM_EFI_APPLICATION</code> . This image is executed and automatically unloaded when the image exits or returns from its entry point.
OS loader	A special type of application that normally does not return or exit. Instead, it calls the UEFI Boot Service <code>gBS >ExitBootServices()</code> to transfer control of the platform from the firmware to an operating system.
Driver	A UEFI image of type <code>EFI_IMAGE_SUBSYSTEM_BOOT_SERVICE_DRIVER</code> or <code>EFI_IMAGE_SUBSYSTEM_RUNTIME_DRIVER</code> . If this image returns <code>EFI_SUCCESS</code> , then the image is not unloaded. If the image returns an error code other than <code>EFI_SUCCESS</code> , then the image is automatically unloaded from system memory. The ability to stay resident in system memory is what differentiates a driver from an application. Because drivers can stay resident in memory, they can provide services to other drivers, applications, or an operating system. Only the services produced by runtime drivers are allowed to persist past <code>gBS >ExitBootServices()</code> .
Service driver	A driver that produces one or more protocols on one or more new service handles and returns <code>EFI_SUCCESS</code> from its entry point.
Initializing driver	A driver that does not create any handles and does not add any protocols to the handle database. Instead, this type of driver performs some initialization operations and returns an error code so the driver is unloaded from system memory.
Root bridge driver	A driver that creates one or more physical controller handles that contain a Device Path Protocol and a protocol that is a software abstraction for the I/O services provided by a root bus produced by a core chipset. The most common root bridge driver is one that creates handles for the PCI root bridges in the platform that support the Device Path Protocol and the PCI Root Bridge I/O Protocol.
EFI 1.02 driver	A driver that follows the <i>EFI 1.02 Specification</i> . This type of driver does not use the UEFI Driver Model. These types of drivers are not discussed in detail in this document. Instead, this document presents recommendations on converting EFI 1.02 drivers to drivers that follow the UEFI Driver Model.
UEFI Driver Model driver	A driver that follows the UEFI Driver Model that is described in detail in the <i>UEFI 2.3 Specification</i> . This type of driver is fundamentally different from service drivers, initializing drivers, root bridge drivers, and EFI 1.02 drivers because a driver that follows the UEFI Driver Model is not allowed to touch hardware or produce device-related services in the driver entry point. Instead, the driver entry point of a driver that follows the UEFI Driver Model is allowed only to register a set of services that allow the driver to be started and stopped at a later point in the system initialization process.

Device driver	A driver that follows the UEFI Driver Model. This type of driver produces one or more driver handles or driver image handles by installing one or more instances of the Driver Binding Protocol into the handle database. This type of driver does not create any child handles when the <code>Start()</code> service of the Driver Binding Protocol is called. Instead, it only adds additional I/O protocols to existing controller handles.
Bus driver	A driver that follows the UEFI Driver Model. This type of driver produces one or more driver handles or driver image handles by installing one or more instances of the Driver Binding Protocol in the handle database. This type of driver creates new child handles when the <code>Start()</code> service of the Driver Binding Protocol is called. It also adds I/O protocols to these newly created child handles.
Hybrid driver	A driver that follows the UEFI Driver Model and shares characteristics with both device drivers and bus drivers. This distinction means that the <code>Start()</code> service of the Driver Binding Protocol will add I/O protocols to existing handles and it will create child handles.

Applications

A UEFI application starts execution at its entry point, then continues execution until it reaches a return from its entry point or it calls the `Exit()` boot service function. When done, the image is unloaded from memory. Some examples of common UEFI applications include the UEFI shell, UEFI shell commands, flash utilities, and diagnostic utilities. It is perfectly acceptable to invoke UEFI applications from inside other UEFI applications.

OS loader

A special type of UEFI application, called an *OS boot loader*, calls the `ExitBootServices()` function when the OS loader has set up enough of the OS infrastructure to be ready to assume ownership of the system resources. At `ExitBootServices()`, the UEFI core frees all of its boot time services and drivers, leaving only the run-time services and drivers.

Drivers

UEFI drivers differ from UEFI applications in that the driver stays resident in memory unless an error is returned from the driver's entry point. The UEFI core firmware, the boot manager, or other UEFI applications may load drivers.

EFI 1.02 Drivers

Several types of UEFI drivers exist, having evolved with subsequent levels of the specification. In EFI 1.02, drivers were constructed without a defined driver model. The *UEFI 2.3 Specification* provides a driver model that replaces the way drivers were built in EFI 1.02 but that still maintains backward compatibility with EFI 1.02 drivers. EFI 1.02 immediately started the driver inside the entry point. Following this method meant that the driver searched immediately for supported devices, installed the necessary I/O protocols, and started the timers that were needed to poll the devices. However, this method did not give the system control over the driver loading and connection policies, so the UEFI Driver Model was introduced in Section 10.1 of the *UEFI 2.3 Specification* to resolve these issues.

The Floating-Point Software Assist (FPSWA) driver is a common example of an EFI 1.02 driver; other EFI 1.02 drivers can be found in the EFI Application Toolkit 1.02.12.38. For compatibility, EFI 1.02 drivers can be converted to UEFI 2.3 drivers that follow the UEFI Driver Model.

Boot Service and Runtime Drivers

Boot-time drivers are loaded into area of memory that are marked as `EfiBootServicesCode`, and the drivers allocate their data structures from memory marked as `EfiBootServicesData`. These memory types are converted to available memory after `gBS->ExitBootServices()` is called.

Runtime drivers are loaded in memory marked as `EfiRuntimeServicesCode`, and they allocate their data structures from memory marked as `EfiRuntimeServicesData`. These types of memory are preserved after `gBS->ExitBootServices()` is called, thereby enabling the runtime driver to provide services to an operating system while the operating system is running. Runtime drivers must publish an alternative calling mechanism, because the UEFI handle database does not persist into OS runtime. The most common examples of UEFI runtime drivers are the Floating-Point Software Assist driver (`FPSWA.efi`) and the network Universal Network Driver Interface (UNDI) driver. Other than these examples, runtime drivers are not very common. In addition, the implementation and validation of runtime drivers is much more difficult than boot service drivers because UEFI supports the translation of run-time services and runtime drivers from a

physical addressing mode to a virtual addressing mode. With this translation, the operating system can make virtual calls to the runtime code. The OS typically runs in virtual mode, so it must transition into physical mode to make the call. Transitions into physical mode for modern, multiprocessor operating systems are expensive because they entail flushing translation look-up blocks (TLB), coordinating all CPUs, and other tasks. As such, UEFI runtime offers an efficient invocation mechanism because no transition is required.

Events and Task Priority Levels

Events are another type of object that is managed through UEFI services. An event can be created and destroyed, and an event can be either in the waiting state or the signaled state. A UEFI image can do any of the following:

- Create an event.
- Destroy an event.
- Check to see if an event is in the signaled state.
- Wait for an event to be in the signaled state.
- Request that an event be moved from the waiting state to the signaled state.

Because UEFI does not support interrupts, it can present a challenge to driver writers who are accustomed to an interrupt-driven driver model. Instead, UEFI supports polled drivers. The most common use of events by a UEFI driver is the use of timer events that allow drivers to periodically poll a device. Figure 2.5 shows the different types of events that are supported in UEFI and the relationships between those events.

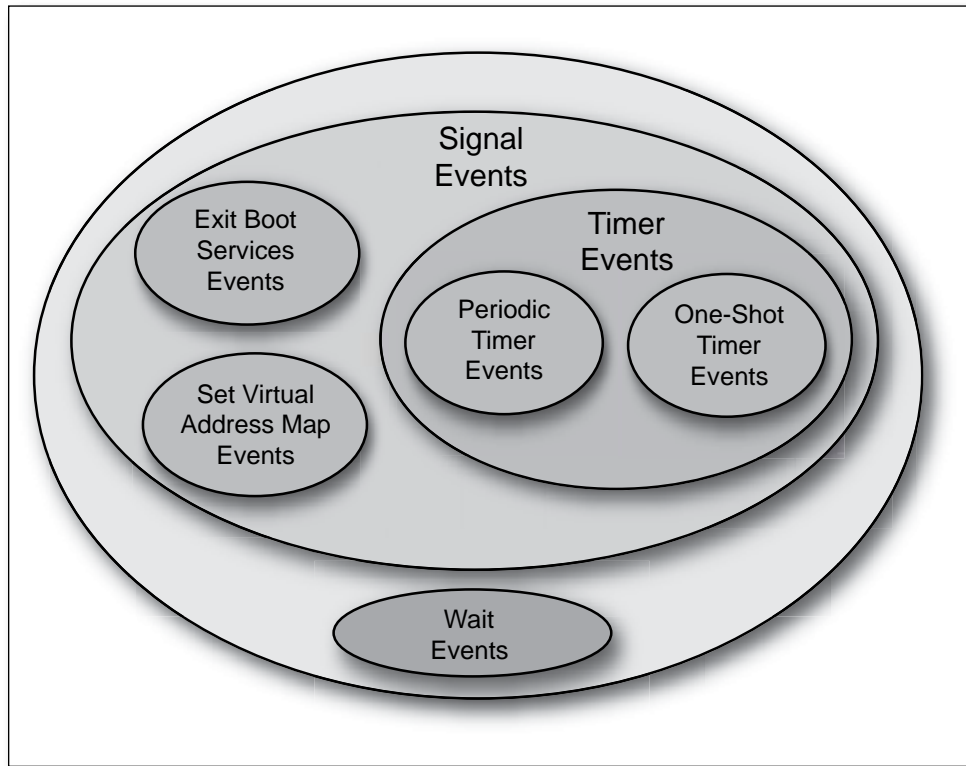

Figure 2.5 Event Types and Relationships

Table 2.2 Description of Event Types

Type of Events	Description
Wait event	An event whose notification function is executed whenever the event is checked or waited upon.
Signal event	An event whose notification function is scheduled for execution whenever the event goes from the waiting state to the signaled state.
Exit Boot Services event	A special type of signal event that is moved from the waiting state to the signaled state when the UEFI Boot Service <code>ExitBootServices()</code> is called. This call is the point in time when ownership of the platform is transferred from the firmware to an operating system. The event's notification function is scheduled for execution when <code>ExitBootServices()</code> is called.
Set Virtual Address Map event	A special type of signal event that is moved from the waiting state to the signaled state when the UEFI Runtime Service <code>SetVirtualAddressMap()</code> is called. This call is the point in time when the operating system is making a request for the runtime components of UEFI to be converted from a physical addressing mode to a virtual addressing mode. The operating system provides the map of virtual addresses to use. The event's notification function is scheduled for execution when <code>SetVirtualAddressMap()</code> is called.
Timer event	A type of signal event that is moved from the waiting state to the signaled state when at least a specified amount of time has elapsed. Both periodic and one-shot timers are supported. The event's notification function is scheduled for execution when a specific amount of time has elapsed.
Periodic timer event	A type of timer event that is moved from the waiting state to the signaled state at a specified frequency. The event's notification function is scheduled for execution when a specific amount of time has elapsed.
One-shot timer event	A type of timer event that is moved from the waiting state to the signaled state after the specified timer period has elapsed. The event's notification function is scheduled for execution when a specific amount of time has elapsed.

The following three elements are associated with every event:

- The Task Priority Level (TPL) of the event
- A notification function
- A notification context

The notification function for a wait event is executed when the state of the event is checked or when the event is being waited upon. The notification

function of a signal event is executed whenever the event transitions from the waiting state to the signaled state. The notification context is passed into the notification function each time the notification function is executed. The TPL is the priority at which the notification function is executed. Table 2.3 lists the four TPL levels that are defined today. Additional TPLs could be added later. An example of a compatible addition to the TPL list could include a series of “Interrupt TPLs” between TPL_NOTIFY and TPL_HIGH_LEVEL in order to provide interrupt-driven I/O support within UEFI.

Table 2.3 Task Priority Levels Defined in UEFI

Task Priority Level	Description
TPL_APPLICATION	The priority level at which UEFI images are executed.
TPL_CALLBACK	The priority level for most notification functions.
TPL_NOTIFY	The priority level at which most I/O operations are performed.
TPL_HIGH_LEVEL	The priority level for the one timer interrupt supported in UEFI.

TPLs serve the following two purposes:

- To define the priority in which notification functions are executed
- To create locks

For priority definition, you use this mechanism only when more than one event is in the signaled state at the same time. In these cases, the application executes the notification function that has been registered with the higher priority first. Also, notification functions at higher priorities can interrupt the execution of notification functions executing at a lower priority.

For creating locks, code running in normal context and code in an interrupt context can access the same data structure because UEFI does support a single-timer interrupt. This access can cause problems and unexpected results if the updates to a shared data structure are not atomic. A UEFI application or UEFI driver that wants to guarantee exclusive access to a shared data structure can temporarily raise the task priority level to prevent simultaneous access from both normal context and interrupt context. The application can create a lock by temporarily raising the task priority level to TPL_HIGH_LEVEL. This level blocks even the one-timer interrupt, but you must take care to minimize the amount of time that the system is at TPL_HIGH_LEVEL. Since all timer-

based events are blocked during this time, any driver that requires periodic access to a device is prevented from accessing its device. A TPL is similar to the IRQL in Microsoft Windows and the SPL in various Unix implementations. A TPL describes a prioritization scheme for access control to resources.

Summary

This chapter has introduced some of the basic UEFI concepts and object types. These items have included events, protocols, task priority levels, image types, handles, GUIDs, and service tables. Many of these UEFI concepts, including images and protocols, are used extensively by other firmware technology, including the UEFI Platform Initialization (PI) building blocks, such as the DXE environment. These concepts will be revisited in different guises in subsequent chapters.

UEFI Driver Model

Things should be made as simple as possible—but no simpler.

—Albert Einstein

The Unified Extensible Firmware Interface (UEFI) provides a driver model for support of devices that attach to today's industry-standard buses, such as Peripheral Component Interconnect (PCI) and Universal Serial Bus (USB), and architectures of tomorrow. The UEFI Driver Model is intended to simplify the design and implementation of device drivers, and produce small executable image sizes. As a result, some complexity has been moved into bus drivers and to a greater extent into common firmware services. A device driver needs to produce a Driver Binding Protocol on the same image handle on which the driver was loaded. It then waits for the system firmware to connect the driver to a controller. When that occurs, the device driver is responsible for producing a protocol on the controller's device handle that abstracts the I/O operations that the controller supports. A bus driver performs these exact same tasks. In addition, a bus driver is also responsible for discovering any child controllers on the bus, and creating a device handle for each child controller found.

The combination of firmware services, bus drivers, and device drivers in any given platform is likely to be produced by a wide variety of vendors including Original Equipment Manufacturers (OEMs), Independent BIOS Vendors (IBVs), and Independent Hardware Vendors (IHVs). These different components from different vendors are required to work together to produce a protocol for an I/O device than can be used to boot a UEFI compliant

operating system. As a result, the UEFI Driver Model is described in great detail in order to increase the interoperability of these components.

This chapter gives a brief overview of the UEFI Driver Model. It describes the entry point of a driver, host bus controllers, properties of device drivers, properties of bus drivers, and how the UEFI Driver Model can accommodate hot plug events.

Why a Driver Model Prior to OS Booting?

Under the UEFI Driver Model, only the minimum number of I/O devices needs to be activated. For example, with today's BIOS-based systems, a server with dozens of SCSI drives needs to have those drives "spun-up" or activated. This is because the BIOS Int19h code does not know a priori which device will contain the operating system loader. The UEFI Driver Model allows for only activating the subset of devices that are necessary for booting. This makes a rapid system restart possible and pushes the policy of which additional devices need activation up into the operating system. With the more aggressive boot time requirements more along the lines of consumer electronics devices being pushed to all open platforms, this capability is imperative.

Driver Initialization

The file for a driver image must be loaded from some type of media. This could include ROM, flash, hard drives, floppy drives, CD-ROM, or even a network connection. Once a driver image has been found, it can be loaded into system memory with the Boot Service `LoadImage()`. `LoadImage()` loads a Portable Executable/Common File Format (PE/COFF) formatted image into system memory. A handle is created for the driver, and a Loaded Image Protocol instance is placed on that handle. A handle that contains a Loaded Image Protocol instance is called an *Image Handle*. At this point, the driver has not been started. It is just sitting in memory waiting to be started. Figure 3.1 shows the state of an image handle for a driver after `LoadImage()` has been called.

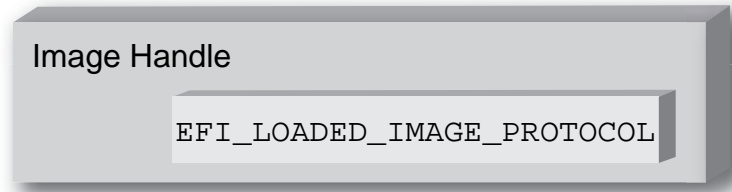

Figure 3.1 Image Handle

After a driver has been loaded with the Boot Service `LoadImage()`, it must be started with the Boot Service `StartImage()`. This is true of all types of UEFI applications and UEFI drivers that can be loaded and started on a UEFI compliant system. The entry point for a driver that follows the UEFI Driver Model must follow some strict rules. First, it is not allowed to touch any hardware. Instead, it is only allowed to install protocol instances onto its own Image Handle. A driver that follows the UEFI Driver Model is *required* to install an instance of the Driver Binding Protocol onto its own Image Handle. It may optionally install the Driver Configuration Protocol, the Driver Diagnostics Protocol, or the Component Name Protocol. In addition, if a driver wishes to be unloadable it may optionally update the Loaded Image Protocol to provide its own `Unload()` function. Finally, if a driver needs to perform any special operations when the Boot Service `ExitBootServices()` is called, it may optionally create an event with a notification function that is triggered when the Boot Service `ExitBootServices()` is called. An Image Handle that contains a Driver Binding Protocol instance is known as a *Driver Image Handle*. Figure 3.2 shows a possible configuration for the Image Handle from Figure 3.1 after the Boot Service `StartImage()` has been called.

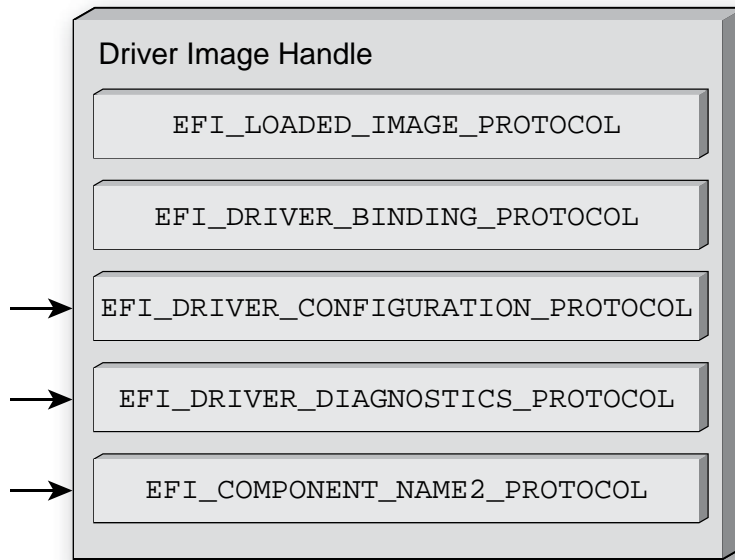

Figure 3.2 Driver Image Handle

Host Bus Controllers

Drivers are not allowed to touch any hardware in the driver's entry point. As a result, drivers are loaded and started, but they are all waiting to be told to manage one or more controllers in the system. A platform component, like the UEFI Boot Manager, is responsible for managing the connection of drivers to controllers. However, before even the first connection can be made, some initial collection of controllers must be present for the drivers to manage. This initial collection of controllers is known as the *Host Bus Controllers*. The I/O abstractions that the Host Bus Controllers provide are produced by firmware components that are outside the scope of the UEFI Driver Model. The device handles for the Host Bus Controllers and the I/O abstraction for each one must be produced by the core firmware on the platform, or a UEFI Driver that may not follow the UEFI Driver Model. See the PCI Host Bridge I/O Protocol description in Chapter 13 of the *UEFI 2.3 specification* for an example of an I/O abstraction for PCI buses.

A platform can be viewed as a set of CPUs and a set of core chip set components that may produce one or more host buses. Figure 3.3 shows a platform with n CPUs, and a set of core chip set components that produce m host bridges.

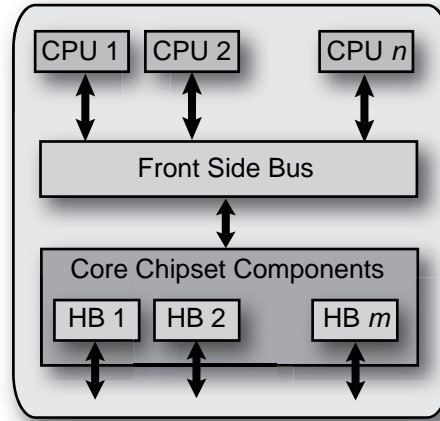

Figure 3.3 Host Bus Controllers

Each host bridge is represented in UEFI as a device handle that contains a Device Path Protocol instance, and a protocol instance that abstracts the I/O operations that the host bus can perform. For example, a PCI Host Bus Controller supports the PCI Host Bridge I/O Protocol. Figure 3.4 shows an example device handle for a PCI Host Bridge.

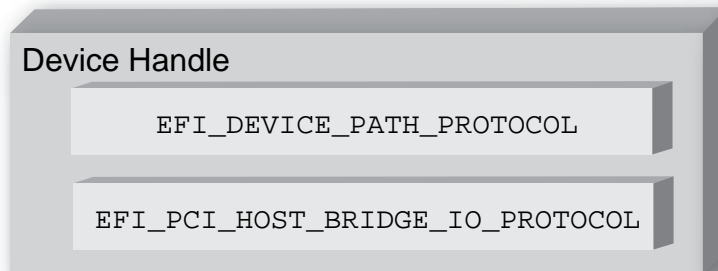

Figure 3.4 Host Bus Device Handle

A PCI Bus Driver could connect to this PCI Host Bridge, and create child handles for each of the PCI devices in the system. PCI Device Drivers should then be connected to these child handles, and produce I/O abstractions that may be used to boot a UEFI compliant OS. The following section describes the different types of drivers that can be implemented within the UEFI Driver Model. The UEFI Driver Model is very flexible, so not all the possible types of drivers are discussed here. Instead, the major types are covered that can be used as a starting point for designing and implementing additional driver types.

Device Drivers

A device driver is not allowed to create any new device handles. Instead, it installs additional protocol interfaces on an existing device handle. The most common type of device driver attaches an I/O abstraction to a device handle that has been created by a bus driver. This I/O abstraction may be used to boot a UEFI compliant OS. Some example I/O abstractions would include Simple Text Output, Simple Input, Block I/O, and Simple Network Protocol. Figure 3.5 shows a device handle before and after a device driver is connected to it. In this example, the device handle is a child of the XYZ Bus, so it contains an XYZ I/O Protocol for the I/O services that the XYZ bus supports. It also contains a Device Path Protocol that was placed there by the XYZ Bus Driver. The Device Path Protocol is not required for all device handles. It is only required for device handles that represent physical devices in the system. Handles for virtual devices do not contain a Device Path Protocol.

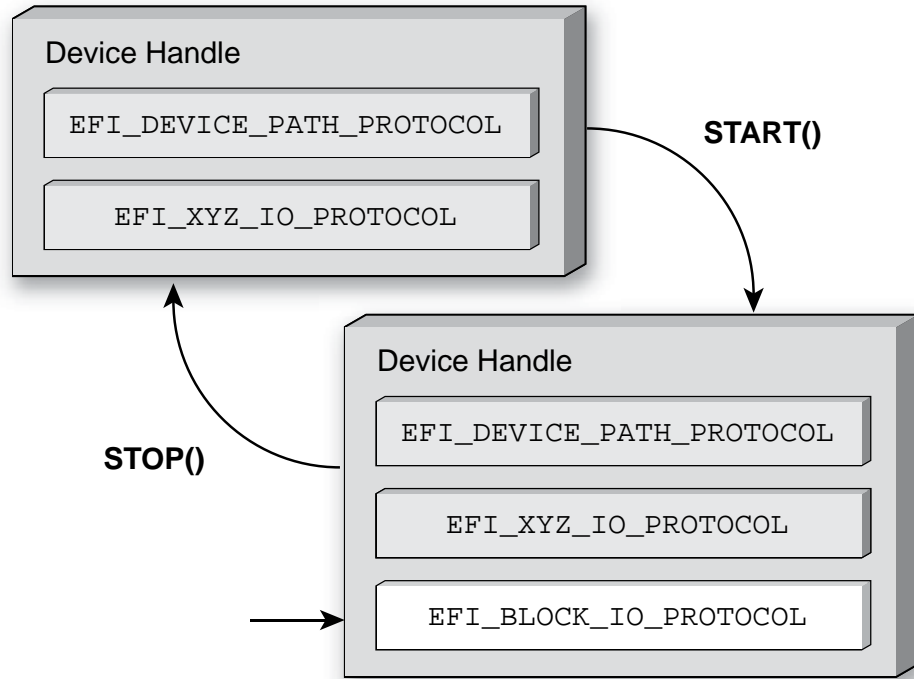

Figure 3.5 Connecting Device Drivers

The device driver that connects to the device handle in Figure 3.5 must have installed a Driver Binding Protocol on its own image handle. The Driver Binding Protocol contains three functions called `Supported()`, `Start()`, and `Stop()`. The `Supported()` function tests to see if the driver supports a given controller. In this example, the driver will check to see if the device handle supports the Device Path Protocol and the XYZ I/O Protocol. If a driver's `Supported()` function passes, then the driver can be connected to the controller by calling the driver's `Start()` function. The `Start()` function is what actually adds the additional I/O protocols to a device handle. In this example, the Block I/O Protocol is being installed. To provide symmetry, the Driver Binding Protocol also has a `Stop()` function that forces the driver to stop managing a device handle. This causes the device driver to uninstall any protocol interfaces that were installed in `Start()`.

The `Support()`, `Start()`, and `Stop()` functions of the UEFI Driver Binding Protocol are required to make use of the new Boot Service `OpenProtocol()` to get a protocol interface and the new Boot Service `CloseProtocol()` to release a protocol interface. `OpenProtocol()` and `CloseProtocol()` update the handle database maintained by the system firmware to track which drivers are consuming protocol interfaces. The information in the handle database can be used to retrieve information about both drivers and controllers. The new Boot Service `OpenProtocolInformation()` can be used to get the list of components that are currently consuming a specific protocol interface.

Bus Drivers

Bus drivers and device drivers are virtually identical from the UEFI Driver Model's point of view. The only difference is that a bus driver creates new device handles for the child controllers that the bus driver discovers on its bus. As a result, bus drivers are slightly more complex than device drivers, but this in turn simplifies the design and implementation of device drivers. There are two major types of bus drivers. The first creates handles for all the child controllers on the first call to `Start()`. The second type allows the handles for the child controllers to be created across multiple calls to `Start()`. This second type of bus driver is very useful in supporting a rapid boot capability. It allows a few child handles or even one child handle to be created. On buses that take a long time to enumerate all of their children (such as SCSI), this can lead to a very large time savings in booting a platform. Figure 3.6 shows the tree structure of a bus controller before and after `Start()` is called. The dashed line coming into the bus controller node represents a link to the bus controller's parent controller. If the bus controller is a Host Bus Controller, then it does not have a parent controller. Nodes A, B, C, D, and E represent the child controllers of the bus controller.

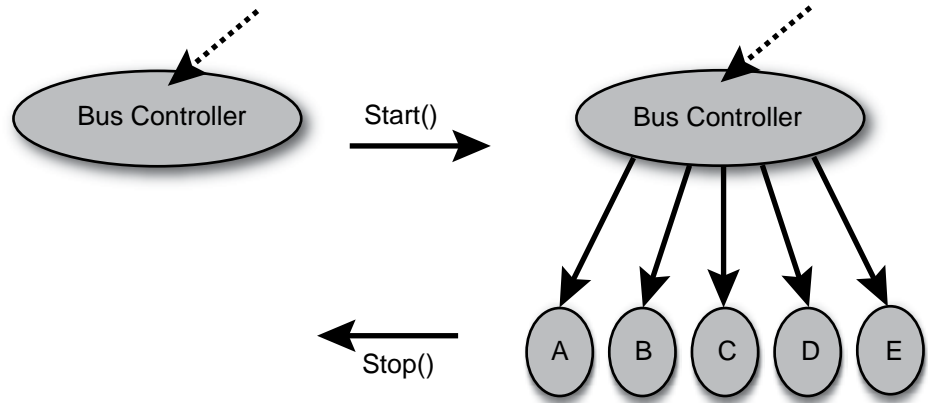

Figure 3.6 Connecting Bus Drivers

A bus driver that supports creating one child on each call to `Start()` might choose to create child C first, and then child E, and then the remaining children A, B, and D. The `Supported()`, `Start()`, and `Stop()` functions of the Driver Binding Protocol are flexible enough to allow this type of behavior.

A bus driver must install protocol interfaces onto every child handle that is created. At a minimum, it must install a protocol interface that provides an I/O abstraction of the bus's services to the child controllers. If the bus driver creates a child handle that represents a physical device, then the bus driver must also install a Device Path Protocol instance onto the child handle. A bus driver may optionally install a Bus Specific Driver Override Protocol onto each child handle. This protocol is used when drivers are connected to the child controllers. A new Boot Service `ConnectController()` uses architecturally defined precedence rules to choose the best set of drivers for a given controller. The Bus Specific Driver Override Protocol has higher precedence than a general driver search algorithm, and lower precedence than platform overrides. An example of a bus specific driver selection occurs with PCI. A PCI Bus Driver gives a driver stored in a PCI controller's option ROM a higher precedence than drivers stored elsewhere in the platform. Figure 3.7 shows an example child device handle that has been created by the XYZ Bus Driver that supports a bus specific driver override mechanism.

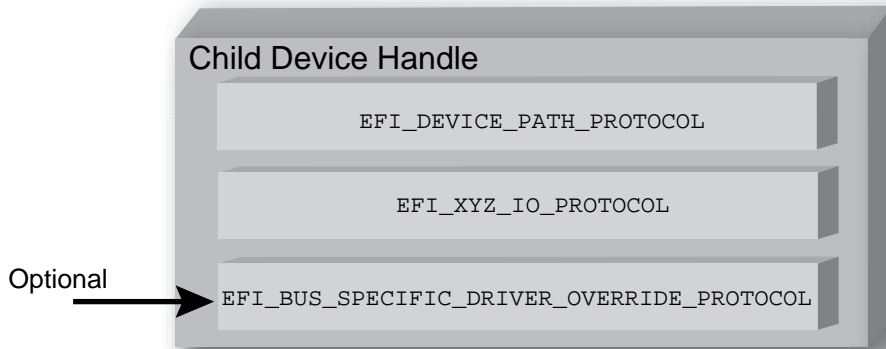

Figure 3.7 Child Device Handle with a Bus Specific Override

Platform Components

Under the UEFI Driver Model, the act of connecting and disconnecting drivers from controllers in a platform is under the platform firmware's control. This will typically be implemented as part of the UEFI Boot Manager, but other implementations are possible. The new Boot Services `ConnectController()` and `DisconnectController()` can be used by the platform firmware to determine which controllers get started and which ones do not. If the platform wishes to perform system diagnostics or install an operating system, then it may choose to connect drivers to all possible boot devices. If a platform wishes to boot a preinstalled operating system, it may choose to only connect drivers to the devices that are required to boot the selected operating system. The UEFI Driver Model supports both of these modes of operation through the new Boot Services `ConnectController()` and `DisconnectController()`. In addition, since the platform component that is in charge of booting the platform has to work with device paths for console devices and boot options, all of the services and protocols involved in the UEFI Driver Model are optimized with device paths in mind.

The platform may also choose to produce an optional protocol named the Platform Driver Override Protocol. This is similar to the Bus Specific Driver Override Protocol, but it has higher priority. This gives the platform firmware the highest priority when deciding which drivers are connected to which controllers. The Platform Driver Override Protocol is attached to a handle in the system. The new Boot Service `ConnectController()` will make use of this protocol if it is present in the system.

Hot Plug Events

In the past, system firmware has not had to deal with hot plug events in the pre-boot environment. However, with the advent of buses like USB, where the end user can add and remove devices at any time, it is important to make sure that it is possible to describe these types of buses in the UEFI Driver Model. It is up to the bus driver of a bus that supports the hot adding and removing of devices to provide support for such events. For these types of buses, some of the platform management is going to have to move into the bus drivers. For example, when a keyboard is added hot to a USB bus on a platform, the end user would expect the keyboard to be active. A USB Bus driver could detect the hot add event and create a child handle for the keyboard device. However, since drivers are not connected to controllers unless `ConnectController()` is called the keyboard would not become an active input device. Making the keyboard driver active requires the USB Bus driver to call `ConnectController()` when a hot add event occurs. In addition, the USB Bus driver would have to call `DisconnectController()` when a hot remove event occurs.

Device drivers are also affected by these hot plug events. In the case of USB, a device can be removed without any notice. This means that the `Stop()` functions of USB device drivers must deal with shutting down a driver for a device that is no longer present in the system. As a result, any outstanding I/O requests must be flushed without actually being able to touch the device hardware.

In general, adding support for hot plug events greatly increases the complexity of both bus drivers and device drivers. Adding this support is up to the driver writer, so the extra complexity and size of the driver must be weighed against the need for the feature in the pre-boot environment.

The two example code sequences below provide guidance on how a device driver writer might discover if it in fact manages the candidate hardware device.

These mechanisms include looking at the controller handle in the first example and examining the device path in the second example.

```

extern EFI_GUID                gEfiDriverBindingProtocolGuid;
EFI_HANDLE                    gMyImageHandle;
EFI_HANDLE                    DriverImageHandle;
EFI_HANDLE                    ControllerHandle;
EFI_DRIVER_BINDING_PROTOCOL   *DriverBinding;
EFI_DEVICE_PATH_PROTOCOL     *RemainingDevicePath;

//
// Use the DriverImageHandle to get the Driver Binding
Protocol
// instance
//
Status = gBS->OpenProtocol (
                DriverImageHandle,
                &gEfiDriverBindingProtocolGuid,
                &DriverBinding,
                gMyImageHandle,
                NULL,
                EFI_OPEN_PROTOCOL_HANDLE_PROTOCOL
            );
if (EFI_ERROR (Status)) {
    return Status;
}

//
// EXAMPLE #1
//
// Use the Driver Binding Protocol instance to test to see
if
// the driver specified by DriverImageHandle supports the
// controller specified by ControllerHandle
//
Status = DriverBinding->Supported (
                DriverBinding,
                ControllerHandle,
                NULL
            );
if (!EFI_ERROR (Status)) {
    Status = DriverBinding->Start (
                DriverBinding,
                ControllerHandle,

```

```

NULL
);
}

return Status;

//
// EXAMPLE #2
//
// The RemainingDevicePath parameter can be used to
initialize
// only the minimum devices required to boot. For example,
// maybe we only want to initialize 1 hard disk on a SCSI
// channel. If DriverImageHandle is a SCSI Bus Driver, and
// ControllerHandle is a SCSI Controller, and we only want
to
// create a child handle for PUN=3 and LUN=0, then the
// RemainingDevicePath would be SCSI(3,0)/END. The
following
// example would return EFI_SUCCESS if the SCSI driver
supports
// creating the child handle for PUN=3, LUN=0. Otherwise
it
// would return an error.
//
Status = DriverBinding->Supported (
    DriverBinding,
    ControllerHandle,
    RemainingDevicePath
);
if (!EFI_ERROR (Status)) {
    Status = DriverBinding->Start (
        DriverBinding,
        ControllerHandle,
        RemainingDevicePath
    );
}

return Status;

```

Pseudo Code

The algorithms for the `Start ()` function for three different types of drivers are presented here. How the `Start ()` function of a driver is implemented can

affect how the `Supported()` function is implemented. All of the services in the `EFI_DRIVER_BINDING_PROTOCOL` need to work together to make sure that all resources opened or allocated in `Supported()` and `Start()` are released in `Stop()`.

The first algorithm is a simple device driver that does not create any additional handles. It only attaches one or more protocols to an existing handle. The second is a simple bus driver that always creates all of its child handles on the first call to `Start()`. It does not attach any additional protocols to the handle for the bus controller. The third is a more advanced bus driver that can either create one child handle at a time on successive calls to `Start()`, or it can create all of its child handles or all of the remaining child handles in a single call to `Start()`. Once again, it does not attach any additional protocols to the handle for the bus controller.

Device Driver

1. Open all required protocols with `OpenProtocol()`. If this driver allows the opened protocols to be shared with other drivers, then it should use an *Attribute* of `EFI_OPEN_PROTOCOL_BY_DRIVER`. If this driver does not allow the opened protocols to be shared with other drivers, then it should use an *Attribute* of `EFI_OPEN_PROTOCOL_BY_DRIVER | EFI_OPEN_PROTOCOL_EXCLUSIVE`. It must use the same *Attribute* value that was used in `Supported()`.
2. If any of the calls to `OpenProtocol()` in Step 1 returned an error, then close all of the protocols opened in Step 1 with `CloseProtocol()`, and return the status code from the call to `OpenProtocol()` that returned an error.
3. Ignore the parameter *RemainingDevicePath*.
4. Initialize the device specified by *ControllerHandle*. If an error occurs, close all of the protocols opened in Step 1 with `CloseProtocol()`, and return `EFI_DEVICE_ERROR`.
5. Allocate and initialize all of the data structures that this driver requires to manage the device specified by *ControllerHandle*. This would include space for public protocols and space for any additional

private data structures that are related to *ControllerHandle*. If an error occurs allocating the resources, then close all of the protocols opened in Step 1 with `CloseProtocol()`, and return `EFI_OUT_OF_RESOURCES`.

6. Install all the new protocol interfaces onto *ControllerHandle* using `InstallProtocolInterface()`. If an error occurs, close all of the protocols opened in Step 1 with `CloseProtocol()`, and return the error from `InstallProtocolInterface()`.
7. Return `EFI_SUCCESS`.

Bus Driver that Creates All of Its Child Handles on the First Call to Start()

1. Open all required protocols with `OpenProtocol()`. If this driver allows the opened protocols to be shared with other drivers, then it should use an *Attribute* of `EFI_OPEN_PROTOCOL_BY_DRIVER`. If this driver does not allow the opened protocols to be shared with other drivers, then it should use an *Attribute* of `EFI_OPEN_PROTOCOL_BY_DRIVER | EFI_OPEN_PROTOCOL_EXCLUSIVE`. It must use the same *Attribute* value that was used in `Supported()`.
2. If any of the calls to `OpenProtocol()` in Step 1 returned an error, then close all of the protocols opened in Step 1 with `CloseProtocol()`, and return the status code from the call to `OpenProtocol()` that returned an error.
3. Ignore the parameter *RemainingDevicePath*.
4. Initialize the device specified by *ControllerHandle*. If an error occurs, close all of the protocols opened in Step 1 with `CloseProtocol()`, and return `EFI_DEVICE_ERROR`.
5. Discover all the child devices of the bus controller specified by *ControllerHandle*.
6. If the bus requires it, allocate resources to all the child devices of the bus controller specified by *ControllerHandle*.

7. FOR each child *C* of *ControllerHandle*.
 8. Allocate and initialize all of the data structures that this driver requires to manage the child device *C*. This would include space for public protocols and space for any additional private data structures that are related to the child device *C*. If an error occurs allocating the resources, then close all of the protocols opened in Step 1 with `CloseProtocol()`, and return `EFI_OUT_OF_RESOURCES`.
 9. If the bus driver creates device paths for the child devices, then create a device path for the child *C* based upon the device path attached to *ControllerHandle*.
 10. Initialize the child device *C*. If an error occurs, close all of the protocols opened in Step 1 with `CloseProtocol()`, and return `EFI_DEVICE_ERROR`.
 11. Create a new handle for *C*, and install the protocol interfaces for child device *C*. This may include the `EFI_DEVICE_PATH_PROTOCOL`.
 12. Call `OpenProtocol()` on behalf of the child *C* with an *Attribute* of `EFI_OPEN_PROTOCOL_BY_CHILD_CONTROLLER`.
13. END FOR
14. Return `EFI_SUCCESS`.

Bus Driver that Is Able to Create All or One of Its Child Handles on Each Call to Start():

1. Open all required protocols with `OpenProtocol()`. If this driver allows the opened protocols to be shared with other drivers, then it should use an *Attribute* of `EFI_OPEN_PROTOCOL_BY_DRIVER`. If this driver does not allow the opened protocols to be shared with other drivers, then it should use an *Attribute* of `EFI_OPEN_PROTOCOL_BY_DRIVER | EFI_OPEN_PROTOCOL_`

EXCLUSIVE. It must use the same *Attribute* value that was used in `Supported()`.

2. If any of the calls to `OpenProtocol()` in Step 1 returned an error, then close all of the protocols opened in Step 1 with `CloseProtocol()`, and return the status code from the call to `OpenProtocol()` that returned an error.
3. Initialize the device specified by *ControllerHandle*. If an error occurs, close all of the protocols opened in Step 1 with `CloseProtocol()`, and return `EFI_DEVICE_ERROR`.
4. IF *RemainingDevicePath* is not NULL, THEN
 5. C is the child device specified by *RemainingDevicePath*.
 6. Allocate and initialize all of the data structures that this driver requires to manage the child device C. This would include space for public protocols and space for any additional private data structures that are related to the child device C. If an error occurs allocating the resources, then close all of the protocols opened in Step 1 with `CloseProtocol()`, and return `EFI_OUT_OF_RESOURCES`.
 7. If the bus driver creates device paths for the child devices, then create a device path for the child C based upon the device path attached to *ControllerHandle*.
 8. Initialize the child device C.
 9. Create a new handle for C, and install the protocol interfaces for child device C. This may include the `EFI_DEVICE_PATH_PROTOCOL`.
 10. Call `OpenProtocol()` on behalf of the child C with an *Attribute* of `EFI_OPEN_PROTOCOL_BY_CHILD_CONTROLLER`.
11. ELSE
 12. Discover all the child devices of the bus controller specified by *ControllerHandle*.

13. If the bus requires it, allocate resources to all the child devices of the bus controller specified by *ControllerHandle*.
14. FOR each child *C* of *ControllerHandle*
 15. Allocate and initialize all of the data structures that this driver requires to manage the child device *C*. This would include space for public protocols and space for any additional private data structures that are related to the child device *C*. If an error occurs allocating the resources, then close all of the protocols opened in Step 1 with `CloseProtocol()`, and return `EFI_OUT_OF_RESOURCES`.
 16. If the bus driver creates device paths for the child devices, then create a device path for the child *C* based upon the device path attached to *ControllerHandle*.
 17. Initialize the child device *C*.
 18. Create a new handle for *C*, and install the protocol interfaces for child device *C*. This may include the `EFI_DEVICE_PATH_PROTOCOL`.
 19. Call `OpenProtocol()` on behalf of the child *C* with an *Attribute* of `EFI_OPEN_PROTOCOL_BY_CHILD_CONTROLLER`.
20. END FOR
21. END IF
22. Return `EFI_SUCCESS`.

Listed below is sample code of the `Start()` function of the device driver for a device on the XYZ bus. The XYZ bus is abstracted with the `EFI_XYZ_IO_PROTOCOL`. This driver does allow the `EFI_XYZ_IO_PROTOCOL` to be shared with other drivers, and just the presence of the `EFI_XYZ_IO_PROTOCOL` on `ControllerHandle` is enough to determine if this driver supports `ControllerHandle`. This driver installs the `EFI_ABC_IO_PROTOCOL` on `ControllerHandle`. The `gBS` and `gMyImageHandle` variables are initialized in this driver's entry point.

The following code sequence provides a generic example of what a driver can do in its start routine in the hope of particularizing the guidance listed above.

```
extern EFI_GUID          gEfiXyzIoProtocol;
extern EFI_GUID          gEfiAbcIoProtocol;
EFI_BOOT_SERVICES_TABLE *gBS;
EFI_HANDLE              gMyImageHandle;

EFI_STATUS
AbcStart (
    IN EFI_DRIVER_BINDING_PROTOCOL  *This,
    IN EFI_HANDLE                  ControllerHandle,
    IN EFI_DEVICE_PATH_PROTOCOL     *RemainingDevicePath
OPTIONAL
)
{
    EFI_STATUS          Status;
    EFI_XYZ_IO_PROTOCOL *XyzIo;
    EFI_ABC_DEVICE      AbcDevice;

    //
    // Open the Xyz I/O Protocol that this driver consumes
    //
    Status = gBS->OpenProtocol (
        ControllerHandle,
        &gEfiXyzIoProtocol,
        &XyzIo,
        gMyImageHandle,
        ControllerHandle,
        EFI_OPEN_PROTOCOL_BY_DRIVER
    );
    if (EFI_ERROR (Status)) {
        return Status;
    }
}
```

```

//
// Allocate and zero a private data structure for the Abc
// device.
//
Status = gBS->AllocatePool (
    EfiBootServicesData,
    sizeof (EFI_ABC_DEVICE),
    &AbcDevice
);
if (EFI_ERROR (Status)) {
    goto ErrorExit;
}
ZeroMem (AbcDevice, sizeof (EFI_ABC_DEVICE));

//
// Initialize the contents of the private data structure
for
// the Abc device. This includes the XyzIo protocol
instance
// and other private data fields and the EFI_ABC_IO_
PROTOCOL
// instance that will be installed.
//
AbcDevice->Signature          = EFI_ABC_DEVICE_SIGNATURE;
AbcDevice->XyzIo              = XyzIo;

AbcDevice->PrivateData1      = PrivateValue1;
AbcDevice->PrivateData1      = PrivateValue2;
. . .
AbcDevice->PrivateData1      = PrivateValueN;

    AbcDevice->AbcIo.Revision    =  EFI_ABC_IO_PROTOCOL_
REVISION;
AbcDevice->AbcIo.Func1       =  AbcIoFunc1;
AbcDevice->AbcIo.Func2       =  AbcIoFunc2;
. . .
AbcDevice->AbcIo.FuncN       =  AbcIoFuncN;

AbcDevice->AbcIo.Data1       =  Value1;
AbcDevice->AbcIo.Data2       =  Value2;
. . .
AbcDevice->AbcIo.DataN       =  ValueN;

//

```

```

// Install protocol interfaces for the ABC I/O device.
//
Status = gBS->InstallProtocolInterface (
    &ControllerHandle,
    &gEfiAbcIoProtocolGuid,
    EFI_NATIVE_INTERFACE,
    &AbcDevice->AbcIo
);
if (EFI_ERROR (Status)) {
    goto ErrorExit;
}

return EFI_SUCCESS;

ErrorExit:
//
// When there is an error, the private data structures
need
// to be freed and the protocols that were opened need
to be
// closed.
//
if (AbcDevice != NULL) {
    gBS->FreePool (AbcDevice);
}
gBS->CloseProtocol (
    ControllerHandle,
    &gEfiXyzIoProtocolGuid,
    gMyImageHandle,
    ControllerHandle
);
return Status;
}

```

Additional Innovations

In addition to the basic capabilities for booting, such as support for the various buses, there are other classes of feature drivers that provide capabilities to the platform. Some examples of these feature drivers include security, manageability, and networking.

Security

In addition to the bus driver-based architecture, the provenance of the UEFI driver may be a concern for some vendors. Specifically, if the UEFI driver is loaded from a host-bus adapter (HBA) PCI card or from the UEFI system partition, the integrity of the driver could be called into question. As such, the *UEFI 2.3 Specification* describes a means by which to enroll signed UEFI drivers and applications. The particular signature format is Authenticode, which is a well-known usage of X509V2 certificates and PKCS#7 signature formats. The use of a well-known embedded signature format in the PE/COFF images of the UEFI drivers allows for interoperable trust, including the use of Certificate Authorities (CAs), such as Verisign, to sign the executables and distribute the credentials. More information on the enrollment can be found in Chapter 27 of the *UEFI 2.3 Specification*. Information on the Windows Authenticode Portable Executable Signature Format can be found at http://www.microsoft.com/whdc/winlogo/drvsign/Authenticode_PE.msp.

Other security features in UEFI 2.3 include the User Identity (UID) infrastructure. The UID allows for the inclusion of credential provider drivers, such as biometric devices, smart cards, and other authentication methods, into a user manager framework. This framework will allow for combining the factors from the various credential providers and assigning rights to different UEFI users. One use case could include only the administrator having access to the USB devices in the pre-OS, whereas other users could only access the boot loader on the UEFI system partition. More information on UID can be found in Chapter 31 of the *UEFI 2.3 Specification*.

Manageability

The UEFI driver model has also introduced the Driver Health Protocol. The Driver Health Protocol exposes additional capabilities that a boot manager might use in concert with a device. These capabilities include `EFI_DRIVER_HEALTH_PROTOCOL.GetHealthStatus()` and `EFI_DRIVER_HEALTH_PROTOCOL.Repair()` services. The former will allow the boot manager to ascertain the state of the device, and the latter API will allow for the invocation of some recovery operation. An example of the usage may include a large solid-state disk cache or redundant array of inexpensive disks (RAID). If the system were powered down during operating system runtime in an inconsistent state, say not having the RAID5 parity disk fully updated, the driver health protocol

would allow for exposing the need to synchronize the cache or RAID during the pre-OS without “disappearing” for a long period during this operation and making the user believe the machine had failed. More information on the Driver Health Protocol can be found in Chapter 10 of the *UEFI 2.3 Specification*.

Networking

The UEFI driver model has also evolved to support complex device hierarchies, such as a dual IPV4 and IPV6 modular network stack. Figure 3.8 is a picture of the Internet Small Computer Systems Interface (iSCSI) network application atop both the IPV4 and IPV6 network stack.

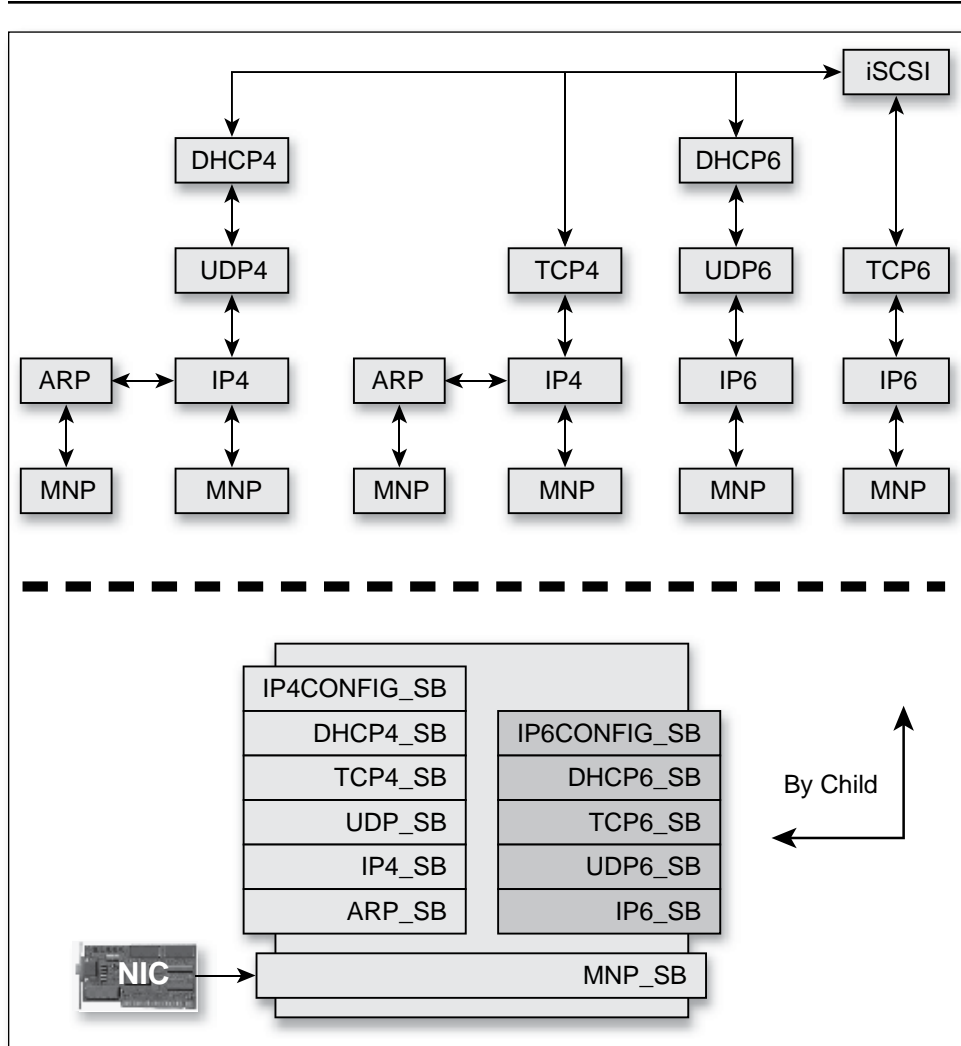

Figure 3.8 iSCSI on IPv4 and IPv6

One notable infrastructure element precipitated by this modular design includes the Service Binding Protocol (SBP). The `EFI_DRIVER_BINDING_PROTOCOL` allows for producing a set of protocols related to a device via simple layering, but for more complex relationships like graphs and trees, the driver binding protocol was found to be deficient. For this reason, the SBP provides a member function to create a child handle with a new protocol installed upon it. This allows for the more generalized driver layering via as shown in Figure 3.8.



Summary

This chapter has introduced the UEFI driver model and some sample drivers. The UEFI driver model allows for support of modern bus architectures in addition to the lazy activation of devices needed by boot for today's platforms and designs in the future. The support for buses is key because most of the storage, console, and networking devices are attached via an industry-standard bus like USB, PCI, and SCSI. The architecture described is general enough to support these and future evolutions in platform hardware. In addition to access to boot devices, though, there are other features and innovations that need to be surfaced in the platform. UEFI drivers are the unit of delivery for these types of capabilities, and examples of networking, security, and management feature drivers were reviewed.

Chapter 4

Protocols You Should Know

Common sense ain't common.

—Will Rogers

This chapter describes protocols that everyone who is working with the Unified Extensible Firmware Interface (UEFI), whether creating device drivers, UEFI pre-OS applications, or platform firmware, should know. The protocols are illustrated by a few examples, beginning with the most common exercise from any programming text, namely “Hello world.” The test application listed here is the simplest possible application that can be written. It does not depend upon any UEFI Library functions, so the UEFI Library is not linked into the executable that is generated. This test application uses the *SystemTable* that is passed into the entry point to get access to the UEFI console devices. The console output device is used to display a message using the `OutputString()` function of the `SIMPLE_TEXT_OUTPUT_INTERFACE` protocol, and the application waits for a keystroke from the user on the console input device using the `WaitForEvent()` service with the *WaitForKey* event in the `SIMPLE_INPUT_INTERFACE` protocol. Once a key is pressed, the application exits.

```
/*++
```

```
Module Name:  
helloworld.c
```

Abstract:

This is a simple module to display behavior of a basic UEFI application.

Author:

Waldo

Revision History

--*/

```
#include "efi.h"
```

```
EFI_STATUS
```

```
InitializeHelloApplication (
    IN EFI_HANDLE          ImageHandle,
    IN EFI_SYSTEM_TABLE   *SystemTable
)
{
    UINTN Index;

    //
    // Send a message to the ConsoleOut device.
    //

    SystemTable->ConOut->OutputString (
        SystemTable->ConOut,
        L"Hello application started\n\r");

    //
    // Wait for the user to press a key.
    //

    SystemTable->ConOut->OutputString (
        SystemTable->ConOut,
        L"\n\r\n\r\n\rHit any key to exit\n\r");

    SystemTable->BootServices->WaitForEvent (
        1,
        &(SystemTable->ConIn->WaitForKey),
        &Index);

    SystemTable->ConOut->OutputString (
        SystemTable->ConOut, L"\n\r\n\r");
}
```

```

//
// Exit the application.
//

return EFI_SUCCESS;
}

```

To execute a UEFI application, type the program's name at the UEFI Shell command line. The following examples show how to run the test application described above from the UEFI Shell. The application waits for the user to press a key before returning to the UEFI Shell prompt. It is assumed that `hello.efi` is in the search path of the UEFI Shell environment.

Example

```
Shell> hello
```

```
Hello application started
```

```
Hit any key to exit this image
```

EFI OS Loaders

This section discusses the special considerations that are required when writing an OS loader. An OS loader is a special type of UEFI application responsible for transitioning a system from a firmware environment into an OS environment. To accomplish this task, several important steps must be taken:

1. The OS loader must determine from where it was loaded. This determination allows an OS loader to retrieve additional files from the same location.
2. The OS loader must determine where in the system the OS exists. Typically, the OS resides on a partition of a hard drive. However, the partition where the OS exists may not use a file system that is recognized by the UEFI environment. In this case, the OS loader can only access the partition as a block device using only block I/O operations. The OS loader will then be required to implement or load the file system driver to access files on the OS partition.

3. The OS loader must build a memory map of the physical memory resources so that the OS kernel can know what memory to manage. Some of the physical memory in the system must remain untouched by the OS kernel, so the OS loader must use the UEFI APIs to retrieve the system's current memory map.
4. An OS has the option of storing boot paths and boot options in nonvolatile storage in the form of environment variables. The OS loader may need to use some of the environment variables that are stored in nonvolatile storage. In addition, the OS loader may be required to pass some of the environment variables to the OS kernel.
5. The next step is to call `ExitBootServices()`. This call can be done from either the OS loader or from the OS kernel. Special care must be taken to guarantee that the most current memory map has been retrieved prior to making this call. Once `ExitBootServices()` had been called, no more UEFI Boot Services calls can be made. At some point, either just prior to calling `ExitBootServices()` or just after, the OS loader will transfer control to the OS kernel.
6. Finally, after `ExitBootServices()` has been called, the UEFI Boot Services calls are no longer available. This lack of availability means that once an OS kernel has taken control of the system, the OS kernel may only call UEFI Runtime Services.

A complete listing of a sample application for an OS loader can be found below. The code fragments in the following sections do not perform any error checking. Also, the OS loader sample application makes use of several UEFI Library functions to simplify the implementation.

The output shown below starts by printing out the device path and the file path of the OS loader itself. It also shows where in memory the OS loader resides and how many bytes it is using. Next, it loads the file `OSKERNEL.BIN` into memory. The file `OSKERNEL.BIN` is retrieved from the same directory as the image of the OS loader sample of Figure 4.1.

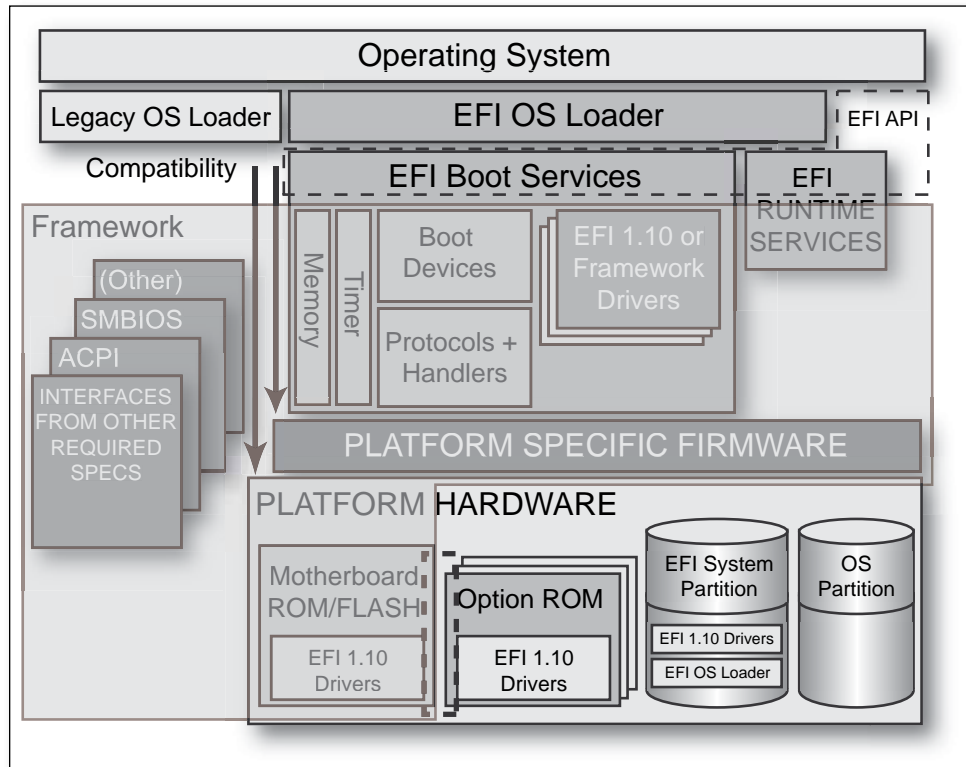

Figure 4.1 EFI Loader in System Diagram

The next section of the output shows the first block of several block devices. The first one is the first block of the floppy drive with a FAT12 file system. The second one is the Master Boot Record (MBR) from the hard drive. The third one is the first block of a large FAT32 partition on the same hard drive, and the fourth one is the first block of a smaller FAT16 partition on the same hard drive.

The final step shows the pointers to all the system configuration tables, the system's current memory map, and a list of all the system's environment variables. The very last step shown is the OS loader calling `ExitBootServices()`.

Device Path and Image Information of the OS Loader

The following code fragment shows the steps that are required to get the device path and file path to the OS loader itself. The first call to `HandleProtocol()` gets the `LOADED_IMAGE_PROTOCOL` interface from the `ImageHandle` that was passed into the OS loader application. The second call to `HandleProtocol()` gets the `DEVICE_PATH_PROTOCOL` interface to the device handle of the OS loader image. These two calls transmit the device path of the OS loader image, the file path, and other image information to the OS loader itself.

```
BS->HandleProtocol (
    ImageHandle,
    &LoadedImageProtocol,
    LoadedImage
);

BS->HandleProtocol (
    LoadedImage->DeviceHandle,
    &DevicePathProtocol,
    &DevicePath
);

Print (
    L"Image device : %s\n",
    DevicePathToStr (DevicePath)
);

Print (
    L"Image file   : %s\n",
    DevicePathToStr (LoadedImage->FilePath)
);

Print (
    L"Image Base   : %X\n",
    LoadedImage->ImageBase
);

Print (
    L"Image Size   : %X\n",
    LoadedImage->ImageSize
);
```

Accessing Files in the Device Path of the OS Loader

The previous section shows how to retrieve the device path and the image path of the OS loader image. The following code fragment shows how to use this information to open another file called `OSKERNEL.BIN` that resides in the same directory as the OS loader itself. The first step is to use `HandleProtocol()` to get the `FILE_SYSTEM_PROTOCOL` interface to the device handle retrieved in the previous section. Then, the disk volume can be opened so file access calls can be made. The end result is that the variable `CurDir` is a file handle to the same partition in which the OS loader resides.

```
BS->HandleProtocol(
    LoadedImage->DeviceHandle,
    &FileSystemProtocol,
    &Vol
);

Vol->OpenVolume (
    Vol,
    &RootFs
);

CurDir = RootFs;
```

The next step is to build a file path to `OSKERNEL.BIN` that exists in the same directory as the OS loader image. Once the path is built, the file handle `CurDir` can be used to call `Open()`, `Close()`, `Read()`, and `Write()` on the `OSKERNEL.BIN` file. The following code fragment builds a file path, opens the file, reads it into an allocated buffer, and closes the file.

```
StrCpy(FileName, DevicePathToStr(LoadedImage->FilePath));
for(i=StrLen(FileName); i>=0 && FileName[i]!='\\'; i--);

FileName[i] = 0;

StrCat(FileName, L"\\OSKERNEL.BIN");
CurDir->Open (CurDir, &FileHandle, FileName, EFI_FILE_
MODE_READ, 0);
```

```

Size = 0x00100000;
BS->AllocatePool(EfiLoaderData, Size, &OsKernelBuffer);

FileHandle->Read(FileHandle, &Size, OsKernelBuffer);

FileHandle->Close(FileHandle);

```

Finding the OS Partition

The UEFI sample environment materializes a `BLOCK_IO_PROTOCOL` instance for every partition that is found in a system. An OS loader can search for OS partitions by looking at all the `BLOCK_IO` devices. The following code fragment uses `LibLocateHandle()` to get a list of `BLOCK_IO` device handles. These handles are then used to retrieve the first block from each one of these `BLOCK_IO` devices. The `HandleProtocol()` API is used to get the `DEVICE_PATH_PROTOCOL` and `BLOCK_IO_PROTOCOL` instances for each of the `BLOCK_IO` devices. The variable `BlkIo` is a handle to the `BLOCK_IO` device using the `BLOCK_IO_PROTOCOL` interface. At this point, a `ReaddBlocks()` call can be used to read the first block of a device. The sample OS loader just dumps the contents of the block to the display. A real OS loader would have to test each block read to see if it is a recognized partition. If a recognized partition is found, then the OS loader can implement a simple file system driver using the UEFI API `ReadBlocks()` function to load additional data from that partition.

```

NoHandles = 0;
HandleBuffer = NULL;
LibLocateHandle(ByProtocol,      &BlockIoProtocol,      NULL,
               &NoHandles, &HandleBuffer);
for(i=0;i<NoHandles;i++) {
    BS->HandleProtocol (
        HandleBuffer[i],
        &DevicePathProtocol,
        &DevicePath
    );
    BS->HandleProtocol (
        HandleBuffer[i],
        &BlockIoProtocol,
        &BlkIo
    );
}

```

```

Block = AllocatePool (BlkIo->BlockSize);
MediaId = BlkIo->MediaId;
BlkIo->ReadBlocks (
    BlkIo,
    MediaId,
    (EFI_LBA) 0,
    BlkIo->BlockSize,
    Block
);

Print (
    L"\nBlock #0 of device %s\n", DevicePathToStr (Device
Path));
DumpHex (0, 0, BlkIo->BlockSize, Block);
}

```

Getting the Current System Configuration

The system configuration is available through the *SystemTable* data structure that is passed into the OS loader. The operating system loader is a UEFI application that is responsible for bridging the gap between the platform firmware and the operating system runtime. The System Table informs the loader of many things: the services available from the platform firmware (such as block and console services for loading the OS kernel binary from media and interacting with the user prior to the OS drivers are loaded, respectively) and access to industry standard tables like ACPI, SMBIOS, and so on. Five tables are available, and their structure and contents are described in the appropriate specifications.

```

LibGetSystemConfigurationTable (
    &AcpiTableGuid, &AcpiTable
);
LibGetSystemConfigurationTable (
    &SMBIOSTableGuid, &SMBIOSTable
);
LibGetSystemConfigurationTable (
    &SalSystemTableGuid, &SalSystemTable
);
LibGetSystemConfigurationTable (
    &MpsTableGuid, &MpsTable
);

```

```

        );

Print(
    L"  ACPI Table is at address          :
    %X\n",AcpiTable
    );
Print(
    L"  SMBIOS Table is at address       :
    %X\n",SMBIOSTable
    );
Print(
    L"  Sal System Table is at address    :
    %X\n",SalSystemTable
    );
Print(
    L"  MPS Table is at address          :
    %X\n",MpsTable
    );

```

Getting the Current Memory Map

One UEFI Library function can retrieve the memory map maintained by the UEFI environment. While the loader is running, the memory has been managed by the platform firmware. It has allocated memory for both firmware usage (boot services memory) and other memory that needs to persist into the OS runtime (runtime memory). Until the loader passes final control to the OS kernel and invokes `ExitBootServices()`, the UEFI platform firmware manages the allocation of memory. The means by which the OS loader and other UEFI applications can ascertain the allocation of memory is via the memory map services. The following code fragment shows the use of this function to ascertain the memory map, and it displays the contents of the memory map. An OS loader must pay special attention to the *MapKey* parameter. Every time that the UEFI environment modifies the memory map that it maintains, the *MapKey* is incremented. An OS loader needs to pass the current memory map to the OS kernel. Depending on what functions the OS loader calls between the time the memory map is retrieved and the time that `ExitBootServices()` is called, the memory map may be modified. In general, the OS loader should retrieve the memory map just before calling `ExitBootServices()`. If `ExitBootServices()` fails because the *MapKey* does not match, then the OS loader must get a new copy of the memory map and try again.

```

MemoryMap = LibMemoryMap(
    &NoEntries,
    &MapKey,
    &DescriptorSize,
    &DescriptorVersion
);

Print(
    L"Memory Descriptor List:\n\n"
);

Print(
    L"  Type          Start Address      End Address      Attributes
\n"
);
Print(
    L"  =====
=====
=====
=====
\n");

MemoryMapEntry = MemoryMap;

for(i=0;i<NoEntries;i++) {
    Print(L"  %s %lX %lX %lX\n",
        OsLoaderMemoryTypeDesc[MemoryMapEntry->Type],
        MemoryMapEntry->PhysicalStart,
        MemoryMapEntry->PhysicalStart +
            LShiftU64(
                MemoryMapEntry->NumberOfPages,
                PAGE_SHIFT)-1,
                MemoryMapEntry->Attribute
            );
    MemoryMapEntry = NextMemoryDescriptor(
        MemoryMapEntry,
        DescriptorSize
    );
}

```

Getting Environment Variables

The following code fragment shows how to extract all the environment variables maintained by the UEFI environment. It uses the `GetNextVariableName()` API to walk the entire list.

```

VariableName[0] = 0x0000;

VendorGuid = NullGuid;

Print(
    L"GUID                                     Variable Name
    Value\n");
Print(
    L"=====
    =====\n");
do {
    VariableNameSize = 256;
    Status = RT->GetNextVariableName(
        &VariableNameSize,
        VariableName,
        &VendorGuid
    );
    if (Status == EFI_SUCCESS) {
        VariableValue = LibGetVariable(
            VariableName,
            &VendorGuid
        );

        Print(
            L"%.-35g %.-20s
            %X\n", &VendorGuid, VariableName, VariableValue
        );
    }
} while (Status == EFI_SUCCESS);

```

Transitioning to an OS Kernel

A single call to `ExitBootServices()` terminates all the UEFI Boot Services that the UEFI environment provides. From that point on, only the UEFI Runtime Services may be used. Once this call is made, the OS loader needs to prepare for the transition to the OS kernel. It is assumed that the OS kernel has full control of the system and that only a few firmware functions are required by the OS kernel. These functions are the UEFI Runtime Services. The OS loader must pass the *SystemTable* to the OS kernel so that the OS kernel can make the Runtime Services calls. The exact mechanism that is used to transition from the OS loader to the OS kernel is implementation-dependent. It is important to note that the OS loader could transition to the OS kernel prior to calling `ExitBootServices()`. In this case, the OS

kernel would be responsible for calling `ExitBootServices()` before taking full control of the system.

Summary

This chapter has provided an overview of some common protocols and their demonstration via a sample operating system loader application. Given that UEFI has been primarily designed as an operating system loader environment, this is a key chapter for demonstrating the usage and capability of the UEFI service set.

Chapter 5

UEFI Runtime

Adding manpower to a late software project makes it later.

—Brook's Law

This chapter describes the fundamental services that are made available in a UEFI-compliant system. The services are defined by interface functions that may be used by code running in the UEFI environment. Such code may include protocols that manage device access or extend platform capabilities. In this chapter, the runtime services will be the focus of discussion. These runtime services are functions that are available both during UEFI operation and when the OS has been launched and running.

During boot, system resources are owned by the firmware and are controlled through a variety of system services that expose callable APIs. In UEFI there are two primary types of services:

- Boot Services – Functions that are available prior to the launching of the boot target (such as the OS), and prior to the calling of the `ExitBootServices()` function.
- Runtime Services – Functions that are available both during the boot phase prior to the launching of the boot target and after the boot target is executing.

Figure 5.1 illustrates the phases of boot operation that a platform evolves through.

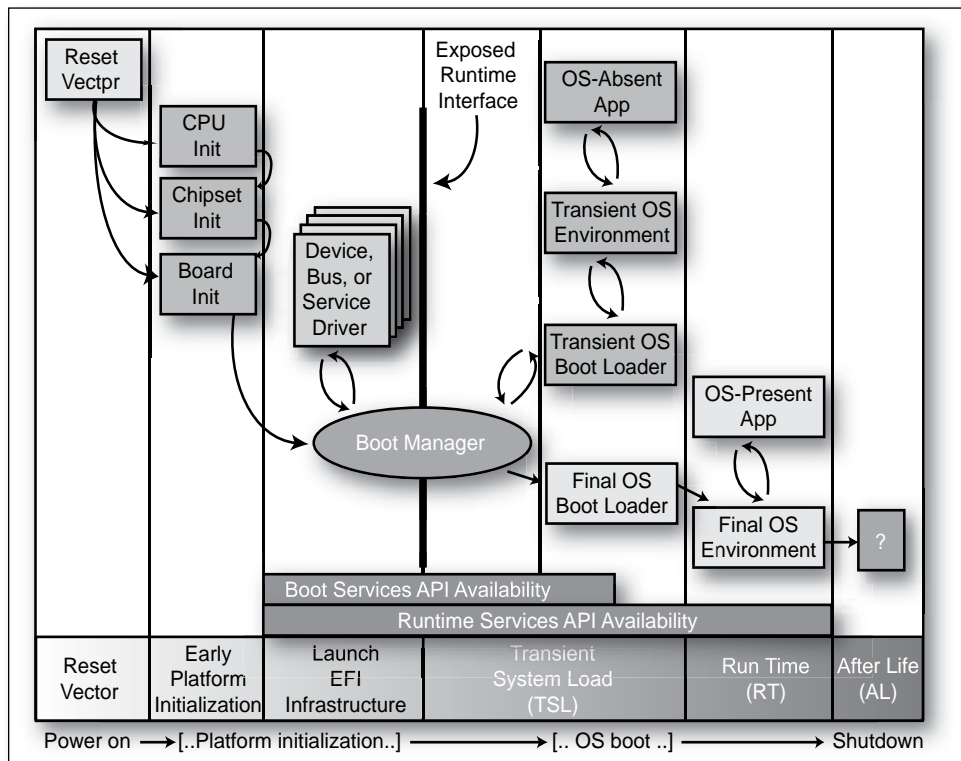

Figure 5.1 Phases of Boot Operation

In Figure 5.1, it is clearly evident that the two previously mentioned forms of services (Boot Services and Runtime Services) are available during the early launch of the UEFI infrastructure and only the runtime services are available after the remainder of the firmware stack has relinquished control to an OS loader. Once an OS loader has loaded enough of its own environment to take control of the system's continued operation it can then terminate the boot services with a call to `ExitBootServices()`.

In principle, the `ExitBootServices()` call is intended for use by the operating system to indicate that its loader is ready to assume control of the platform and all platform resource management. Thus boot services are available up to this point to assist the OS loader in preparing to boot the operating system. Once the OS loader takes control of the system and completes the operating system boot process, only runtime services may be called. Code other than the OS loader, however, may or may not choose to call

`ExitBootServices()`. This choice may in part depend upon whether or not such code is designed to make continued use of UEFI boot services or the boot services environment.

■ Isn't There Only One Kind of Memory?

When UEFI memory is allocated, it is “typed” according to certain classifications which designate the general purpose of a particular memory type. For instance, one might choose to allocate a buffer as an `EfiRuntimeServicesData` buffer if it was desired that a buffer containing some data remained available into the runtime phase of platform operations. When allocating memory, one might think “Why not allocate everything as a runtime memory type ‘just in case?’” The reason that such activity is hazardous is that when the platform transitions from Boot Services phase into Runtime phase, all of the buffers which might have been allocated as runtime are now frozen and unavailable to the OS. Since there is an implicit assumption that items which request runtime-enabled memory know what they are doing, one can imagine a proliferation of memory leaks if we simply assumed a single type of memory usage. With this situation in mind, UEFI establishes a certain set of memory types with certain expected usage associated with each.

Table 5.1 UEFI Memory Types and Usage Prior to `ExitBootServices()`

Mnemonic	Description
<code>EfiReservedMemoryType</code>	Not used.
<code>EfiLoaderCode</code>	The code portions of a loaded application. (Note that UEFI OS loaders are UEFI applications.)
<code>EfiLoaderData</code>	The data portions of a loaded application and the default data allocation type used by an application to allocate pool memory.
<code>EfiBootServicesCode</code>	The code portions of a loaded Boot Services Driver.
<code>EfiBootServicesData</code>	The data portions of a loaded Boot Services Driver, and the default data allocation type used by a Boot Services Driver to allocate pool memory.
<code>EfiRuntimeServicesCode</code>	The code portions of a loaded Runtime Services Driver.
<code>EfiRuntimeServicesData</code>	The data portions of a loaded Runtime Services Driver and the default data allocation type used by a Runtime Services Driver to allocate pool memory.
<code>EfiConventionalMemory</code>	Free (unallocated) memory.
<code>EfiUnusableMemory</code>	Memory in which errors have been detected.
<code>EfiACPIReclaimMemory</code>	Memory that holds the ACPI tables.
<code>EfiACPIMemoryNVS</code>	Address space reserved for use by the firmware.
<code>EfiMemoryMappedIO</code>	Used by system firmware to request that a memory-mapped IO region be mapped by the OS to a virtual address so it can be accessed by UEFI runtime services.
<code>EfiMemoryMappedIOPortSpace</code>	System memory-mapped IO region that is used to translate memory cycles to IO cycles by the processor.
<code>EfiPalCode</code>	Address space reserved by the firmware for code that is part of the processor.

Table 5.1 lists memory types and their corresponding usage prior to launching a boot target (such as an OS). The memory types that would be used by most runtime drivers would be those with the keyword “runtime” in them.

However, to better illustrate how these memory types are used in the runtime phase of the platform evolution, Table 5.2 illustrates how these UEFI Memory types are used after the OS loader has called `ExitBootServices()` to indicate the transition from the pre-boot, to the runtime phase of operations.

Table 5.2 UEFI Memory Types and Usage after `ExitBootServices()`

Mnemonic	Description
<code>EfiReservedMemoryType</code>	Not used.
<code>EfiLoaderCode</code>	The Loader and/or OS may use this memory as they see fit. Note: the OS loader that called <code>ExitBootServices()</code> is utilizing one or more <code>EfiLoaderCode</code> ranges.
<code>EfiLoaderData</code>	The Loader and/or OS may use this memory as they see fit. Note: the OS loader that called <code>ExitBootServices()</code> is utilizing one or more <code>EfiLoaderData</code> ranges.
<code>EfiBootServicesCode</code>	Memory available for general use.
<code>EfiBootServicesData</code>	Memory available for general use.
<code>EfiRuntimeServicesCode</code>	The memory in this range is to be preserved by the loader and OS in the working and ACPI S1–S3 states.
<code>EfiRuntimeServicesData</code>	The memory in this range is to be preserved by the loader and OS in the working and ACPI S1–S3 states.
<code>EfiConventionalMemory</code>	Memory available for general use.
<code>EfiUnusableMemory</code>	Memory that contains errors and is not to be used.
<code>EfiACPIReclaimMemory</code>	This memory is to be preserved by the loader and OS until ACPI is enabled. Once ACPI is enabled, the memory in this range is available for general use.
<code>EfiACPIMemoryNVS</code>	This memory is to be preserved by the loader and OS in the working and ACPI S1–S3 states.
<code>EfiMemoryMappedIO</code>	This memory is not used by the OS. All system memory-mapped IO information should come from ACPI tables.
<code>EfiMemoryMappedIOPortSpace</code>	This memory is not used by the OS. All system memory-mapped IO port space information should come from ACPI tables.
<code>EfiPalCode</code>	This memory is to be preserved by the loader and OS in the working and ACPI S1–S3 states. This memory may also have other attributes that are defined by the processor implementation.

In Table 5.2, one can see how the runtime memory types are preserved, and the `BootServices` type of memory is available for the OS to reclaim as its own.

How Are Runtime Services Exposed?

In UEFI, firmware services are exposed through a set of UEFI protocol definitions, a series of function pointers in some special purpose service tables, and finally in the UEFI configuration table. Of these mechanisms that are used to expose firmware APIs, only the following two are persistent into the runtime phase of computer operations.

- **Runtime Services Table** - The UEFI Runtime Services Table contains pointers to all of the runtime services. All elements in the UEFI Runtime Services Table are prototypes of function pointers that are valid after the operating system has taken control of the platform with a call to `ExitBootServices()`.
- **UEFI Configuration Table** - The UEFI Configuration Table contains a set of GUID/pointer pairs. The number of entries in this table can easily grow over time. That is why a GUID is used to identify the configuration table type. This table may contain at most one instance of each table type.

The runtime services that are exposed in the UEFI Runtime Services Table at minimum define the core required runtime API capabilities of a UEFI-compliant platform. These functions include services that expose time, virtual memory, and variable services at a minimum.

The information exposed through the UEFI Configuration Table is going to vary widely between platform implementations. One key thing to note, however, is that the GUID associated with the GUID/pointer pair defines how one interprets the data to which the pointer is pointing. The content to which the pointer is pointed could be a function/API, a table of data, or practically anything else. Some examples of the type of information that can be exposed through this table are SMBIOS, ACPI, and MPS tables, as well as function prototypes for an UEFI-compliant network card. Figure 5.2 is an example diagram of the interactions between the UEFI Configuration Table and an example function prototype.

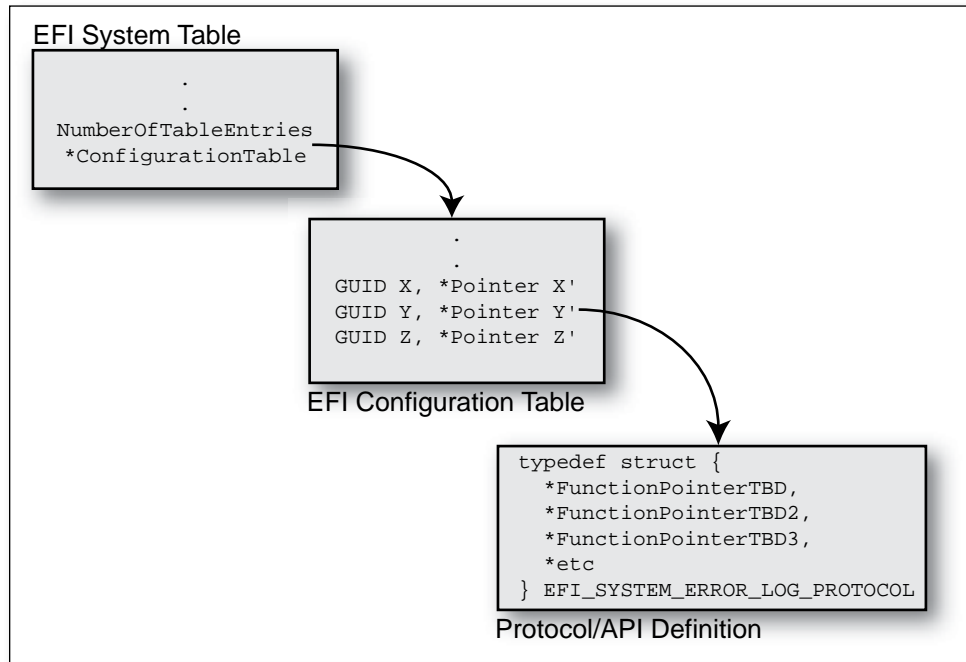

Figure 5.2 Interactions between the UEFI Configuration Table and a Function Prototype

Time Services

This section describes the core UEFI definitions for time-related functions that are specifically needed by operating systems at runtime to access underlying hardware that manages time information and services. The purpose of these interfaces is to provide runtime consumers of these services an abstraction for hardware time devices, thereby relieving the need to access legacy hardware devices directly. The functions listed in Table 5.3 reside in the UEFI Runtime Services table.

Table 5.3 Time-based Functions in the UEFI Runtime Services Table

Name	Type	Description
GetTime	Runtime	Returns the current time and date, and the time-keeping capabilities of the platform.
SetTime	Runtime	Sets the current local time and date information.
GetWakeupTime	Runtime	Returns the current wakeup alarm clock setting.
SetWakeupTime	Runtime	Sets the system wakeup alarm clock time.

Why Abstract Time?

For a variety of reasons one might choose to abstract the access to the platform RealTime Clock (RTC). First, very poor standard mechanisms (if any) exist to access the platform's RTC. A variety of legacy interrupts might serve some purposes, but typically might not abstract sufficient information to be particularly useful. If a user wanted to talk to the RTC directly, the user would not typically know how to with the exception of using some of the standard IBM CMOS directives. Ultimately, how one might gain access to this fundamental piece of information ("What time is it?") could change over time. With that in mind, one needed the platform to provide a set of abstractions so that the caller would not have to worry about the vagaries of varying programming some RTC to acquire time information or to depend on some poorly documented and completely nonstandard set of legacy interrupts to abstract this same data.

Get Time

Even though this function is called "GetTime", it is intended to return the current time as well as the date information along with the capabilities of the current underlying time-based hardware. This service is not intended to provide highly accurate timings beyond certain described levels. During the Boot Services phase of platform initialization, there are other means by which to do accurate time stall measurements (for example, see the `Stall()` boot services function in the UEFI specification).

Even though Figure 5.3 shows the smallest granularity of time measurement in nanoseconds, this by no means is intended as an indication of the accuracy of the time measurement of which the function is capable. The only thing

that is guaranteed by the call to this function is that it returns a time that was valid during the call to the function. This guarantee is more understandable when one thinks about the processing time for the call to traverse various levels of code between the caller and the service function actually talking to the hardware device and this data then being passed back to the caller. Since this is a call initiated during the runtime phase of platform operations, the highly accurate timers that are needed for small granularity timing events would be provided by alternate (likely OS-based) solutions.

```
//*****
//EFI_TIME
//*****
// This represents the current time information
typedef struct {
    UINT16      Year;           // 1998 - 20XX
    UINT8       Month;         // 1 - 12
    UINT8       Day;           // 1 - 31
    UINT8       Hour;          // 0 - 23
    UINT8       Minute;        // 0 - 59
    UINT8       Second;        // 0 - 59
    UINT8       Pad1;
    UINT32      Nanosecond;    // 0 - 999,999,999
    INT16       TimeZone;     // -1440 to 1440 or 2047
    UINT8       Daylight;
    UINT8       Pad2;
} EFI_TIME;
```

Figure 5.3 Example Time Definition

Set Time

This function provides the ability to set the current time and date information on the platform.

Get Wakeup Time

This function provides the abstraction for obtaining the alarm clock settings for the platform. This is often used to determine if a platform has been set for being woken up, and if so, at what time it should be woken up.

Set Wakeup Time

Setting a system wakeup alarm causes the system to wake up or power on at the set time. When the alarm fires, the alarm signal is latched until acknowledged by calling `SetWakeupTime()` to disable the alarm. If the alarm fires before the system is put into a sleeping or off state, since the alarm signal is latched the system will immediately wake up.

Virtual Memory Services

This section contains function definitions for the virtual memory support that may be optionally used by an operating system at runtime. If an operating system chooses to make UEFI runtime service calls in a virtual addressing mode instead of the flat physical mode, then the operating system must use the services in this section to switch the UEFI runtime services from flat physical addressing to virtual addressing. Table 5.4 lists the virtual memory services functions that UEFI provides.

Table 5.4 Virtual Memory Services

Name	Type	Description
<code>SetVirtualAddressMap</code>	Runtime	Used by an OS loader to convert from physical addressing to virtual addressing.
<code>ConvertPointer</code>	Runtime	Used by UEFI components to convert internal pointers when switching to virtual addressing.

By using these functions, the platform provides a mechanism by which components that will exist during the runtime phase of operations can adjust their own data references to the new virtual addresses that the runtime caller has supplied. This makes it possible for the underlying firmware component(s) to adjust from a physical address mode to virtual address mode entity.

This conversion applies to all functions in the runtime services table as well as the pointers in the UEFI System Table. However, this is not necessarily the case for the UEFI Configuration Table. In the UEFI Configuration Table, one is dealing with GUID/pointer pairs, and since the pointers are all physical to start with in the firmware, one might think that the pointers are converted

during the transition to the runtime phase of platform operations, right? In this particular case, you would be wrong.

The GUID portion of the GUID/pointer pair defines the state of the pointer itself. In theory, one might have a particular GUID that during runtime has a virtual address pointer paired with it, but the next GUID in the table might very well be a physical pointer. This is because the UEFI Configuration Table can often be used to advertise certain pieces of information and the consumer of this information might have reason for interpreting the pointer as a physical pointer even though the OS has converted all other pertinent data to virtual addresses. In addition, the UEFI Configuration Table often might be pointing to a runtime enabled function prototype. In most cases, the pointers for this function would be converted, while other items that might be pointed at by the UEFI Configuration Table (Data Tables, for instance) might have no reason to have any data converted.

Set Virtual Address Map

By calling this service, the agent that is the owner of the system's memory map (the component that called `ExitBootServices()`) can change the runtime addressing mode of the underlying UEFI firmware from physical to virtual. The inputs of course are the new virtual memory map which shows an array of memory descriptors that have mapping information for all runtime memory ranges.

When this service is called, all runtime-enabled agents will in turn be called through a notification event triggered by the `SetVirtualAddressMap()` function.

ConvertPointer

The `ConvertPointer` function is used by a UEFI component during the `SetVirtualAddressMap()` operation. When the platform has passed control to an OS loader and it in turn calls `SetVirtualAddressMap()`, a function is called in most runtime drivers that responds to the virtual address change event that is triggered. This function uses the `ConvertPointer` service to convert the current physical pointer to an appropriate virtual address pointer. All pointers that the component has allocated should be updated using this mechanism.

Variable Services

Variables are defined as key/value pairs that consist of identifying information, attributes, and some quantity of data. Variables are intended for use as a means to store data that is passed between the UEFI environment implemented in the platform and UEFI OS loaders and other applications that run in the UEFI environment.

Although the implementation of variable storage is not specifically defined for a given platform, variables must be able to persist across reboots of the platform. This implies that the UEFI implementation on a platform must arrange it so that variables passed in for storage are retained and available for use each time the system boots, at least until they are explicitly deleted or overwritten. Provision of this type of nonvolatile storage may be very limited on some platforms, so variables should be used sparingly in cases where other means of communicating information cannot be used. Table 5.5 lists the variable services functions that UEFI provides.

Table 5.5 Variable Services

Name	Type	Description
GetVariable	Runtime	Returns the value of a variable.
GetNextVariableName	Runtime	Enumerates the current variable names.
SetVariable	Runtime	Sets the value of a variable.

GetVariable

This function returns the value of a given UEFI variable. Since a fully qualified UEFI variable name is composed of both a human-readable text value paired with a GUID, a vendor can create and manage its own variables without the risk of name conflicts by using its own unique GUID value. For instance, one can easily have three variables named “Setup” that are wholly unique assuming that each of these “Setup” variables has a different numeric GUID value.

One of the key items to note in the definition of a UEFI variable is that each one has some attributes associated with it. These attributes are treated as a bit field, which implies that none, any, or all of the bits can be activated at any given time. In the case of UEFI variables, however, there are three defined attribute bits to be aware of:

- Nonvolatile – a variable that has this attribute activated is defined to be persistent across platform resets. It should also be noted that the explicit absence of this bit being activated indicates that the variable is volatile, and is therefore a temporary variable that will be absent once the system resets or the variable is deleted.
- BootService – a variable that has this attribute activated provides read/write access to it during the BootService phase of the platform evolution. This simply means that once the platform enters the runtime phase, the data will no longer be able to be set through the SetVariable service.
- Runtime – a variable that has this attribute activated must also have the BootService attribute activated. With this, the variable is accessible during all phases of the platform evolution.

GetNextVariableName

Since the UEFI variable repository is very similar in concept to a file system, the ability to parse the repository is provided by the GetNextVariableName service. This service enumerates the current variable names in the platform, and with each subsequent call to the service the previous results can be passed into the interface, and on output the interface returns the next variable name data. Once the entire list of variables has been returned, a subsequent call into the service providing the previous “last” variable name will provide the equivalent of a “Not Found” error.

It should be noted that this service is affected by the phase of platform operations. Variables that do not have the runtime attribute activated are allocated typically from some type of BootServices memory. Since this is the case, once `ExitBootServices()` is performed to signify the transition into the runtime phase, these variables will no longer show up in the search list that GetNextVariableName provides.

One other behavior that should be noted is that one might conceive that if a variable has the ability to be named the same human-readable name (such as “Setup”) and the only thing that differs is the GUID, one could seed the search mechanism for this service by walking a common GUID-based list of variables. This is not the case. The usage of this service is typically initiated

with a call that starts with a pointer to a Null Unicode string as the human-readable name; the GUID is ignored. Instead, the entire list of variables must be retrieved, and the caller may act as a filter if you choose to have it do so.

SetVariable

UEFI variables are often used to provide a means by which to save platform-based context information. For instance, when the platform initializes the I/O infrastructure and has probed for all known console output devices, it will likely construct a ConOutDev global variable. These global variables have a unique purpose in the platform since they have a specific architectural role to play with a specific purpose. Table 5.6 shows some of the defined global variables.

Table 5.6 Global Variables

Variable Name	Attribute	Description
LangCodes	BS, RT	The language codes that the firmware supports. This value is deprecated.
Lang	NV, BS, RT	The language code that the system is configured for. This value is deprecated.
Timeout	NV, BS, RT	The firmware's boot managers timeout, in seconds, before initiating the default boot selection.
PlatformLangCodes	BS, RT	The language codes that the firmware supports.
PlatformLang	NV, BS, RT	The language code that the system is configured for.
ConIn	NV, BS, RT	The device path of the default input console.
ConOut	NV, BS, RT	The device path of the default output console.
ErrOut	NV, BS, RT	The device path of the default error output device.
ConInDev	BS, RT	The device path of all possible console input devices.
ConOutDev	BS, RT	The device path of all possible console output devices.
ErrOutDev	BS, RT	The device path of all possible error output devices.

The examples in Table 5.6 show some of the common global variables, their descriptions, and their attributes. Some of the noted differences are the presence or absence of the NV (nonvolatile) attribute. This simply means that the values associated with these variables are not persistent across platform resets and their values are determined during the initialization phase of platform operations.

Unlike variables that are persistent, robust implementations of UEFI enable the setting of volatile variables in memory-backed store, and do not necessarily have the storage size sensitivities that the other variables have that are stored in a fixed hardware with often very limited storage capacity.

Software should only use a nonvolatile variable when absolutely necessary. It should be noted that a variable has no concept of a zero-byte data payload. All variables must contain at least 1 byte of data, since the service definition stipulates that the means by which you delete a target variable is by calling the `SetVariable()` service with a zero byte data payload.

There are certain rules that should definitely be noted when it comes to the use of the attributes:

- Attributes are only applied to a variable when the variable is created. If a preexisting variable is rewritten with different attributes, the result is indeterminate and may vary between implementations. The correct method of changing the attributes of a variable is to delete the variable and recreate it with different attributes.
- Setting a data variable with no access attributes or a zero size data payload causes it to be deleted.
- Runtime access to a data variable implies boot service access.
- Once `ExitBootServices()` is performed, data variables that did not have the runtime access attribute set are no longer visible. This simply enforces the paradigm that once in runtime phase, variables without the runtime attribute are not to be read from.
- Once `ExitBootServices()` is performed, only variables that have the runtime and the nonvolatile access attributes set can be set with a call to the `SetVariable()` service. In addition, variables that have runtime access but that are not nonvolatile are now read-only data variables. The reason for this situation is that once the platform firmware has handed off control to another agent (such as the OS), it no longer controls the memory services and cannot further allocate services that might be backed by memory. Since the `SetVariable` service typically uses memory to spill content to store

a volatile variable, this capability is no longer available during the runtime phase of operations.

By providing a mechanism for shared data content such as a UEFI variable, the use of variables can be seen as a fairly flexible and highly available mechanism for firmware components to communicate. The variables shown in Table 5.6 are some of the architectural variables that steer the behavior of a platform. In this case aspects of the platform configuration can be seen in the data reflected by these variables. Another usage of the variable services can be to use the volatile (one must stress volatile, and not nonvolatile) variable as means by which two disparate components can have a common repository that is independent of a nonvolatile backing store (such as a harddisk), yet can act as a temporary repository of data such as registry content that is discovered by one agent and retrieved by another. This infrastructure provides for a lot of flexibility in implementation.

Miscellaneous Services

This section contains the remaining function definitions for runtime services that were not talked about in previous sections but are required to complete a compliant implementation of a UEFI environment. The services that are in this section are as listed in Table 5.7.

Table 5.7 Miscellaneous Services

Name	Type	Description
GetNextHighMonotonicCount	Runtime	Returns the next high 32 bits of the platform's monotonic counter.
ResetSystem	Runtime	Resets the entire platform.
UpdateCapsule	Runtime	Pass capsules to the firmware. The firmware may process the capsules immediately or return a value to be passed into <code>ResetSystem()</code> that will cause the capsule to be processed by the firmware as part of the reset process.
QueryCapsuleCapabilities	Runtime	Returns if the capsule can be supported via <code>UpdateCapsule()</code>

Reset System

This service provides a caller the ability to reset the entire platform including all processors and devices, and reboots the system. This service provides the ability to stipulate three types of resets:

- Cold Reset – A call to the `ResetSystem()` service stipulating a cold reset will cause a system-wide reset. This sets all circuitry within the system to its initial state. This type of reset is asynchronous to system operation and operates without regard to cycle boundaries. This is tantamount to a system power cycle.
- Warm Reset – Calling the `ResetSystem()` service stipulating a warm reset will also cause a system-wide initialization. The processors are set to their initiate state, and pending cycles are not corrupted. This difference should be noted, since memory is not typically reinitialized and that the machine may be rebooting without having cleared memory that previously existed. There are a lot of examples of this usage model, and implementations vary on exactly what platforms choose to do with this type of feature. If the system does not support this reset type, then a Cold Reset must be performed.
- Reset Shutdown – Calling the `ResetSystem()` service stipulating a Reset Shutdown will cause the system to enter a power state equivalent to the ACPI G2/S5 or G3 states. If the system does not support this reset type, then when the system is rebooted, it should exhibit the same attributes as having booted from a Cold Reset.

Get Next High Monotonic Count

The platform provides a service to get the platform monotonic counter. The platform's monotonic counter is comprised of two 32-bit quantities: the high 32 bits and the low 32 bits. During boot service time the low 32-bit value is volatile: it is reset to zero on every system reset and is increased by 1 on every call to `GetNextMonotonicCount()`. The high 32-bit value is nonvolatile and will be increased by 1 whenever the system resets or whenever the low 32-bit count overflows.

Since the `GetNextMonotonicCount()` service is available only at boot services time, and if the operating system wishes to extend the platform monotonic counter to runtime, it may do so by utilizing the `GetNextHighMonotonicCount()` runtime service. To do this, before calling `ExitBootServices()` the operating system would call `GetNextMonotonicCount()` to obtain the current platform monotonic count. The operating system would then provide an interface that returns the next count by:

- Adding 1 to the last count.
- Before the lower 32 bits of the count overflows, call `GetNextHighMonotonicCount()`. This will increase the high 32 bits of the platform's nonvolatile portion of the monotonic count by 1.

This function may only be called at runtime.

UpdateCapsule

This runtime function allows a caller to pass information to the firmware. `UpdateCapsule` is commonly used to update the firmware FLASH or for an operating system to have information persist across a system reset. Other usage models such as updating platform configuration are also possible depending on the underlying platform support.

A capsule is simply a contiguous set of data that starts with an `EFI_CAPSULE_HEADER`. The `CapsuleGuid` field in the header defines the format of the capsule.

The capsule contents are designed to be communicated from an OS-present environment to the system firmware. To allow capsules to persist across system reset, a level of indirection is required for the description of a capsule, since the OS primarily uses virtual memory and the firmware at boot time uses physical memory. This level of abstraction is accomplished via the `EFI_CAPSULE_BLOCK_DESCRIPTOR`. The `EFI_CAPSULE_BLOCK_DESCRIPTOR` allows the OS to allocate contiguous virtual address space and describe this address space to the firmware as a discontinuous set of physical address ranges. The firmware is passed both physical and virtual addresses and pointers to describe the capsule so the firmware can process the capsule immediately or defer processing of the capsule until after a system reset.

Depending on the intended consumption, the firmware may process the capsule immediately. If the payload should persist across a system reset, the reset value returned from `QueryCapsuleCapabilities` must be passed into `ResetSystem()` and will cause the capsule to be processed by the firmware as part of the reset process.

QueryCapsuleCapabilities

This runtime function allows a caller to check whether or not a particular capsule can be supported by the platform prior to sending it to the `UpdateCapsule` routine. Many of these checks are based on the type of capsule being passed and their associated flag values contained within the capsule header.

Summary

This chapter has introduced some of the basic UEFI runtime capabilities. These are unique in that they are the few aspects of the firmware that will reside in the system even when the target software (such as the operating system) is running. These are the functions that can be leveraged any time during the platform's evolution from pre-OS through the runtime phases.

Chapter 6

UEFI Console Services

Never test for an error condition you don't know how to handle.

—Steinbach's Guideline for Systems Programming

This chapter describes how UEFI extends the traditional boundaries of console support in the pre-boot phase and provides a series of software layering approaches that are commonly used in UEFI-compliant platforms. Most platforms, at minimum, would have a text-based console for a user to either locally or remotely interact with the system. A variety of mechanisms can accomplish this communication in UEFI. Whether it is through a remote interface, through a local keyboard and monitor, or even a remote network connection, each has a common root that can be thought of as the basic UEFI console support. This support is used to handle input and output of text-based information intended for the system user during the operation of code in the UEFI boot services environment. These console definitions are split into three types of console devices: one for input, and one each for normal output and errors.

These interfaces are specified by function call definitions to allow maximum flexibility in implementation. For example, a compliant system is not required to have a keyboard or screen directly connected to the system. As long as the semantics of the functions are preserved, implementations may direct information using these interfaces in any way that succeeds in passing the information to the system user.

The UEFI console is built out of two primary protocols: UEFI Simple Text Input and UEFI Simple Text Output. These two protocols implement a basic text-based console that allows platform firmware, UEFI applications, and UEFI OS loaders to present information to and receive input from a system administrator. The UEFI console consists of 16-bit Unicode characters, a simple set of input control characters known as scan codes, and a set of output-oriented programmatic interfaces that give functionality equivalent to an intelligent terminal. In the UEFI 2.1 specification, an extension to the Simple Text Input protocol was introduced (now referred to as Simple Text Input Ex), which greatly expanded the supportable keys as well as state information that can be retrieved from the keyboard. This text-based set of interfaces does not inherently support pointing devices on input or bitmaps on output.

To ensure greatest interoperability, the UEFI Simple Text Output protocol is recommended to support at least the printable basic Latin Unicode character set to enable standard terminal emulation software to be used with a UEFI console. The basic Latin Unicode character set implements a superset of ASCII that has been extended to 16-bit characters. This provides the maximum interoperability with external terminal emulations that might otherwise require the conversion of text encoding to be down-converted to a set of ASCII equivalents.

UEFI has a variety of system-wide references to consoles. The UEFI System Table contains six console-related entries:

- `ConsoleInHandle` – The handle for the active console input device. This handle must support the UEFI Simple Text Input protocol and the UEFI Simple Text Input Ex protocol.
- `ConIn` – A pointer to the UEFI Simple Text Input protocol interface that is associated with `ConsoleInHandle`.
- `ConsoleOutHandle` – The handle for the active console output device. This handle must support the UEFI Simple Text Output protocol.
- `ConOut` – A pointer to the UEFI Simple Text Output protocol interface that is associated with `ConsoleOutHandle`.

- `StandardErrorHandle` – The handle for the active standard error console device. This handle must support the UEFI Simple Text Output protocol.
- `StdErr` – A pointer to the UEFI Simple Text Output protocol interface that is associated with `StandardErrorHandle`.

Other system-wide references to consoles in UEFI are contained within the global variable definitions. Some of the pertinent global variable definitions in UEFI are:

- `ConIn` – The UEFI global variable that contains the device path of the default input console.
- `ConInDev` – The UEFI global variable that contains the device path of all possible console input devices.
- `ConOut` – The UEFI global variable that contains the device path of the default output console.
- `ConOutDev` – The UEFI global variable that contains the device path of all possible console output devices.
- `ErrOut` – The UEFI global variable that contains the device path of the default error console.
- `ErrOutDev` – The UEFI global variable that contains the device path of all possible console output devices.

Figure 6.1 illustrates the software layering discussed so far. A UEFI application or driver that wants to communicate through a text interface can use the active console shown in the UEFI System Table to call the interface that supports the appropriate text input or text output protocol. During initialization, the system table is passed to the launched UEFI application or driver, and this component can then immediately start using the console in question.

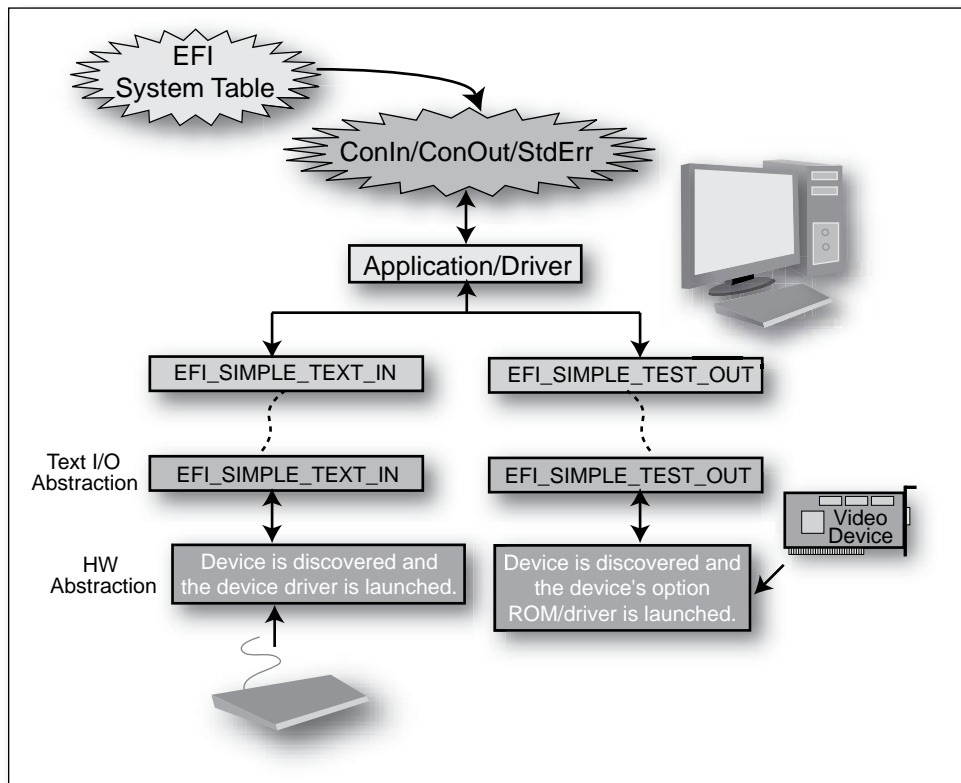

Figure 6.1 Initial Software Layering

To further describe these interactions it is necessary to delve a bit deeper into what these text I/O interfaces really look like and what they are effectively responsible for.

Simple Text Input Protocol

The Simple Text Input Protocol defines the minimum input required to support a specific ConIn device. This interface provides two basic functions for the caller:

- **Reset** – This function resets the input device hardware. As part of the initialization process, the firmware/device makes a quick but reasonable attempt to verify that the device is functioning. This

hardware verification process is implementation-specific and is left up to the firmware and/or UEFI driver to implement.

- **ReadKeyStroke** – This function reads the next keystroke from the input device. If no keystroke is pending, the function returns a UEFI Not Ready error. If a keystroke is pending, a UEFI key is returned. A UEFI key is composed of a scan code as well as a Unicode character. The Unicode character is the actual printable character or is zero if the key is not represented by a printable character, such as the control key or a function key.

When reading a key from the `ReadKeyStroke()` function, a UEFI Input Key is retrieved. In traditional firmware, all PS/2 keys had a hardware specific scan code, which was the sole item firmware dealt with. In UEFI, things have been changed a bit to facilitate the reasonable transaction of this data both with local and remote users. The data sent back has two primary components:

- **Unicode Character** – The Simple Text Input protocol defines an input stream that contains Unicode characters. This value represents the Unicode-encoded 16-bit value that corresponds to the key that was pressed by the user. A few Unicode characters have special meaning and are thus defined as supported Unicode control characters, as described in Table 6.1.

Table 6.1 UEFI-supported Unicode Control Characters

Mnemonic	Unicode	Description
Null	U+0000	Null character ignored when received.
BS	U+0008	Backspace. Moves cursor left one column. If the cursor is at the left margin, no action is taken.
TAB	U+0x0009	Tab.
LF	U+000A	Linefeed. Moves cursor to the next line.
CR	U+000D	Carriage Return. Moves cursor to left margin of the current line.

- **Scan Code** - The input stream supports UEFI scan codes in addition to Unicode characters. If the scan code is set to 0x00 then the Unicode character is valid and should be used. If the UEFI scan code is set to a value other than 0x00, it represents a special key as defined in Table 6.2.

Table 6.2 UEFI-supported Scan Codes

UEFI Scan Code	Description
0x00	Null scan code.
0x01	Move cursor up 1 row.
0x02	Move cursor down 1 row.
0x03	Move cursor right 1 column.
0x04	Move cursor left 1 column.
0x05	Home.
0x06	End.
0x07	Insert.
0x08	Delete.
0x09	Page Up.
0x0a	Page Down.
0x0b	Function 1.
0x0c	Function 2.
0x0d	Function 3.
0x0e	Function 4.
0x0f	Function 5.
0x10	Function 6.
0x11	Function 7.
0x12	Function 8.
0x13	Function 9.
0x14	Function 10.
0x17	Escape.

The `ReadKeyStroke` function provides the additional capability to signal a UEFI event when a key has been received. To leverage this capability, one must use either the `WaitForEvent` or `CheckEvent` services. The event to pass into these services is the following:

- `WaitForKey` – The event to use when calling `WaitForEvent()` to wait for a key to be available.

The activity being handled by the Simple Text Input protocol is very similar to the INT 16h services that were available in legacy firmware. Some of the primary differences are that the legacy firmware service returned only the ASCII equivalent 8-bit value for the key that was pressed along with the hardware-specific (such as PS/2) scan codes.

Simple Text Input Ex Protocol

The Simple Text Input Ex protocol provides the same functionality that the Simple Text Input protocol produced and adds a series of additional capabilities. This interface provides a few new basic functions for the caller:

- `ReadKeyStrokeEx` – This function reads the next keystroke from the input device. It operates in a fashion similar to the `ReadKeyStroke` from the Simple Text Input protocol, except it has the ability to extract a series of extended keystrokes that were not previously possible (See Table 6.3 and Table 6.4). This includes both shift state (for example, Left Control key pressed, Right Shift pressed, and so on), and toggle information (for example, Caps Lock is turned on). If no keystroke is pending, the function returns an EFI Not Ready error. If a keystroke is pending, a UEFI key is returned.
- Key Registration Capabilities – This set of functions provides for the ability to register and unregister a set of keystrokes so that when a user hits the same keystroke, a notification function is called. This is useful in the case where there is a desire to have a particular hot-key registered and then associated with a particular piece of software. This capability is often associated with the `KEY####` UEFI global variable, which associated a key sequence with a particular `BOOT####` variable target.

- `SetState` – This function allows the settings of certain state data for a given input device. This data often encompasses information such as whether or not Caps Lock, Num Lock, or Scroll Lock are active.

Table 6.3 Simple Text Input Ex Keyboard Shift States

Key Shift State Mask Value	Description
0x80000000	If high bit is on, then the state value is valid. For devices that are not capable of producing shift state values, this value will be off.
0x01	Right Shift key is pressed.
0x02	Left Shift key is pressed.
0x04	Right Control key is pressed.
0x08	Left Control key is pressed.
0x10	Right Alt key is pressed.
0x20	Left Alt key is pressed.
0x40	Right logo key is pressed.
0x80	Left logo key is pressed.
0x100	Menu key is pressed.
0x200	System Request (SysReq) key is pressed.

Table 6.4 Simple Text Input Ex Keyboard Toggle States

Keyboard Toggle State Mask Value	Description
0x80	If high bit is on, then the state value is valid. For devices that are not capable of representing toggle state values, this value will be off.
0x01	Scroll Lock is active.
0x02	Num Lock is active.
0x04	Caps Lock is active.

Simple Text Output Protocol

The Simple Text Output protocol is used to control text-based output devices. It is the minimum required protocol for any handle supplied as the `ConOut` or

StdOut device. In addition, the minimum supported text mode of such devices is at least 80 × 25 characters.

A video device that supports only graphics mode is required to emulate text mode functionality. Output strings themselves are not allowed to contain any control codes other than those defined in Table 6.1. Positional cursor placement is done only via the `SetCursorPosition()` function. It is highly recommended that text output to the `StdErr` device be limited to sequential string outputs. That is, it is not recommended to use `ClearScreen()` or `SetCursorPosition()` on output messages to `StdErr`, so that this data can be clearly captured or viewed.

The Simple Text Output protocol also has a pointer to some mode data, as shown in Figure 6.2. This mode data is used to determine what the current text settings are for the given device. Much of this information is used to determine what the current cursor position is as well as the given foreground and background color. In addition, one can stipulate whether a cursor should be visible or not.

```
typedef struct {
    INT32                               MaxMode;
    // current settings
    INT32                               Mode;
    INT32                               Attribute;
    INT32                               CursorColumn;
    INT32                               CursorRow;
    BOOLEAN                             CursorVisible;
}SIMPLE_TEXT_OUTPUT_MODE;
```

Figure 6.2 Mode Structure for UEFI Simple Text Output Protocol

The Simple Text Output protocol also has a variety of text output related functions; however, this chapter focuses on some of the most commonly used ones:

- `OutputString` – Provides the ability to write a NULL-terminated Unicode string to the output device and have it displayed. All output devices must also support some of the basic Unicode drawing characters listed in the *UEFI 2.1 Specification*. This is the most basic output mechanism on an output device. The string is displayed at the current cursor location on the output device(s) and the cursor is advanced according to the rules listed in Table 6.5.

Table 6.5 Cursor Advancement Rules

Mnemonic	Unicode	Description
Null	U+0000	Ignore the character, and do not move the cursor.
BS	U+0008	If the cursor is not at the left edge of the display, then move the cursor left one column.
LF	U+000A	If the cursor is at the bottom of the display, then scroll the display one row, and do not update the cursor position. Otherwise, move the cursor down one row.
CR	U+000D	Move the cursor to the beginning of the current row.
Other	U+XXXX	Print the character at the current cursor position and move the cursor right one column. If this moves the cursor past the right edge of the display, then the line should wrap to the beginning of the next line. This is equivalent to inserting a CR and an LF. Note that if the cursor is at the bottom of the display, and the line wraps, then the display will be scrolled one line.

By providing an abstraction that allows a console device, such as a video driver, to produce a text interface, this can be compared to legacy firmware support for INT 10h. The producer of the Simple Text Output interface is responsible for converting the Unicode text characters into the appropriate glyphs for that device. In the case where an unrecognized Unicode character has been sent to the `OutputString()` API, the result is typically a warning that indicates that these characters were skipped.

- `SetAttribute` – This function sets the background and foreground colors for both the `OutputString()` and `ClearScreen()` functions. A variety of foreground and background colors are defined by the *UEFI 2.1 Specification*. The color mask can be set even if the device is in an invalid text mode. Devices that support a different number of text colors must emulate the specified colors to the best of the device’s capabilities.
- `ClearScreen` – This function clears the output device(s) display to the currently selected background color. The cursor position is set to (0, 0).
- `SetCursorPosition` – This function sets the current coordinates of the cursor position. The upper left corner of the screen is defined as coordinate (0, 0).

Remote Console Support

The previous sections of this chapter described some of the text input and output protocols, and used some examples that were generated through local devices. UEFI also supports many types of remote console. This support leverages the preexisting local interfaces but enables the routing of this data to and from devices outside of the platform being executed.

When a remote console is instantiated, it typically results from UEFI constructing an I/O abstraction that a console driver latches onto. In this case, the discussion initially concerns serial interface consoles. A variety of console transport protocols, such as PC ANSI, VT-100, and so on, describe the format of the data that is sent to and from the machine.

The console driver responsible for producing the Text I/O interfaces acts as a filter for the I/O. For example, when a remote key is pressed, this might require a variety of pieces of data to be constructed and sent from the remote device and upon receipt, the console driver needs to interpret this information and convert it into the corresponding UEFI semantics such as the UEFI scan code and Unicode character. The same is true for any application running on the local machine that prints a message. This message is received by the console driver and translated to the remote terminal type semantics.

Table 6.6 gives examples of how a UEFI scan code can be mapped to ANSI X3.64 terminal, PC-ANSI terminal, or an AT 101/102 keyboard. PC ANSI terminals support an escape sequence that begins with the ASCII character 0x1b and is followed by the ASCII character 0x5B, “[“. ASCII characters that define the control sequence that should be taken follow the escape sequence. The escape sequence does not contain spaces, but spaces are used in Table 6.6 for ease of reading. For additional information on UEFI terminal support, see the latest *UEFI Specification*.

Table 6.6 Sample Conversion Table for UEFI Scan Codes to other Terminal Formats

EFI Scan Code	Description	ANSI X3.64 Codes	PC ANSI Codes	AT 101/102 Keyboard Scan Codes
0x00	Null scan code	N/A	N/A	N/A
0x01	Move cursor up 1 row	CSI A	ESC [A	0xe0, 0x48
0x02	Move cursor down 1 row	CSI B	ESC [B	0xe0, 0x50
0x03	Move cursor right 1 column	CSI C	ESC [C	0xe0, 0x4d
0x04	Move cursor left 1 column	CSI D	ESC [D	0xe0, 0x4b
0x05	Home	CSI H	ESC [H	0xe0, 0x47
0x06	End	CSI K	ESC [K	0xe0, 0x4f
0x07	Insert	CSI @	ESC [@	0xe0, 0x52
0x08	Delete	CSI P	ESC [P	0xe0, 0x53
0x09	Page Up	CSI ?	ESC [?	0xe0, 0x49
0x0a	Page Down	CSI /	ESC [/	0xe0, 0x51

Table 6.7 shows some of the PC ANSI and ANSI X3.64 control sequences for adjusting display/text display attributes for text displays.

Table 6.7 Example Control Sequences that Can Be Used in Console Drivers

PC ANSI Codes	ANSI X3.64 Codes	Description
ESC [2 J	CSI 2 J	Clear Display Screen.
ESC [0 m	CSI 0 m	Normal Text.
ESC [1 m	CSI 1 m	Bright Text.
ESC [7 m	CSI 7 m	Reversed Text.
ESC [30 m	CSI 30 m	Black foreground, compliant with ISO Standard 6429.
ESC [31 m	CSI 31 m	Red foreground, compliant with ISO Standard 6429.
ESC [32 m	CSI 32 m	Green foreground, compliant with ISO Standard 6429.
ESC [33 m	CSI 33 m	Yellow foreground, compliant with ISO Standard 6429.
ESC [34 m	CSI 34 m	Blue foreground, compliant with ISO Standard 6429.

Figure 6.3 illustrates the software layering for a remote serial interface with Text I/O abstractions. The primary difference between this illustration and one that exhibits the same Text I/O abstractions on local devices is that this one has one additional layer of software drivers. In the former examples, the local device was discovered by an agent, launched, and it in turn would establish a set of Text I/O abstractions. In the remote case, the local device is a serial device, which has a console driver that is layered onto it, and it in turn would establish a set of Text I/O abstractions.

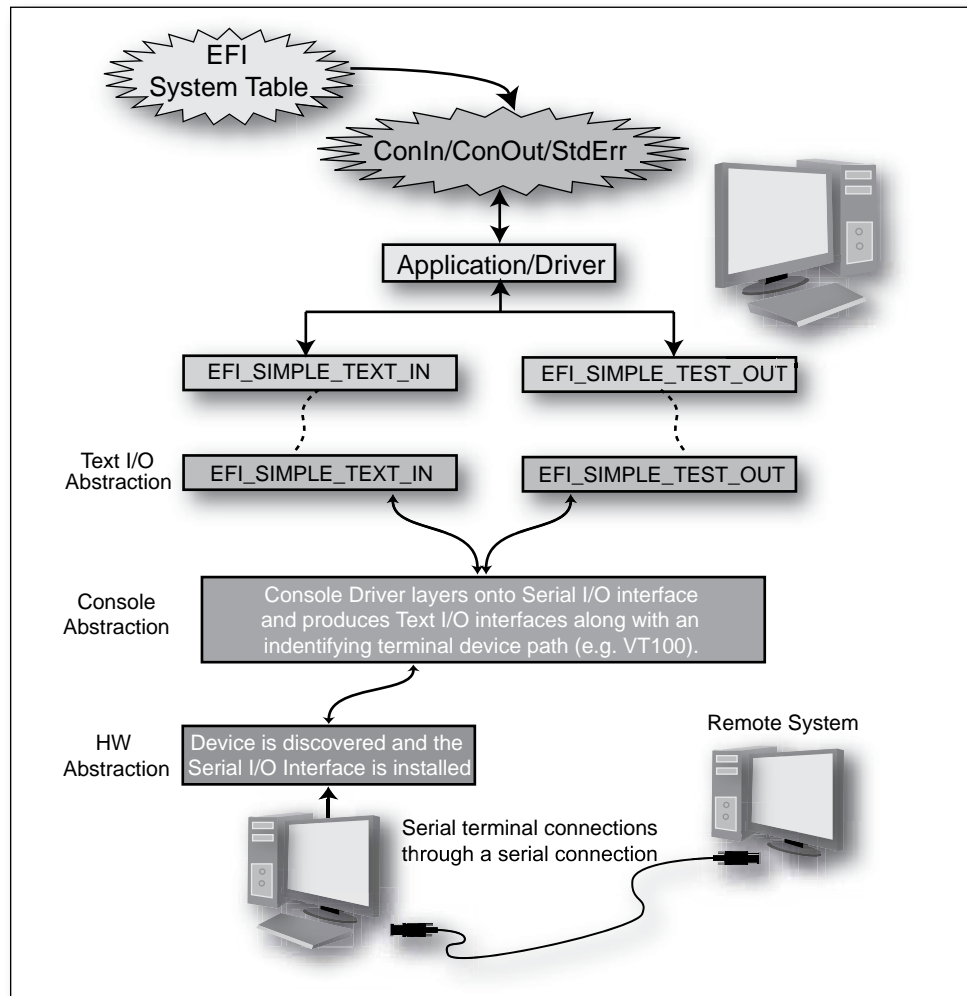

Figure 6.3 Remote Console Software Layering

Console Splitter

The ability to describe a variety of console devices poses interesting new possibilities. In previous generations of firmware, one had a single means by which one could describe what the Text I/O sources and targets were. Now the UEFI variables that specify the active consoles are specified by a device path. In this case, these device paths are multi-instance, meaning that more than one target device could be the active input or output. For instance, if one wanted to be able to have an application print text to the local screen as well as to the screen of a remote terminal, it would be highly impractical for anyone to customize their software to accommodate that particular scenario. In the solution that UEFI provides with its console splitting/merging capability, an application can simply use the standard text interfaces that UEFI provides and the console splitter routes the text requests to the appropriate target or targets. This works for both input as well as output streams.

The way this works is that when the UEFI-compliant platform initializes, the console splitter installs itself in the UEFI System Table as the primary active console. In doing so, it can then proceed to monitor the platform as other UEFI text interfaces get installed as protocols and the console splitter keeps a running tally of the user selected devices for a given console variable, such as `ConOut`, `ConIn`, or `ErrOut`.

Figure 6.4 illustrates a scenario where an application is calling UEFI text interfaces, which in turn calls the UEFI System Table console interfaces. These interfaces belong to the console splitter, and the console splitter then sends the text I/O requests from the application to the platform-configured consoles.

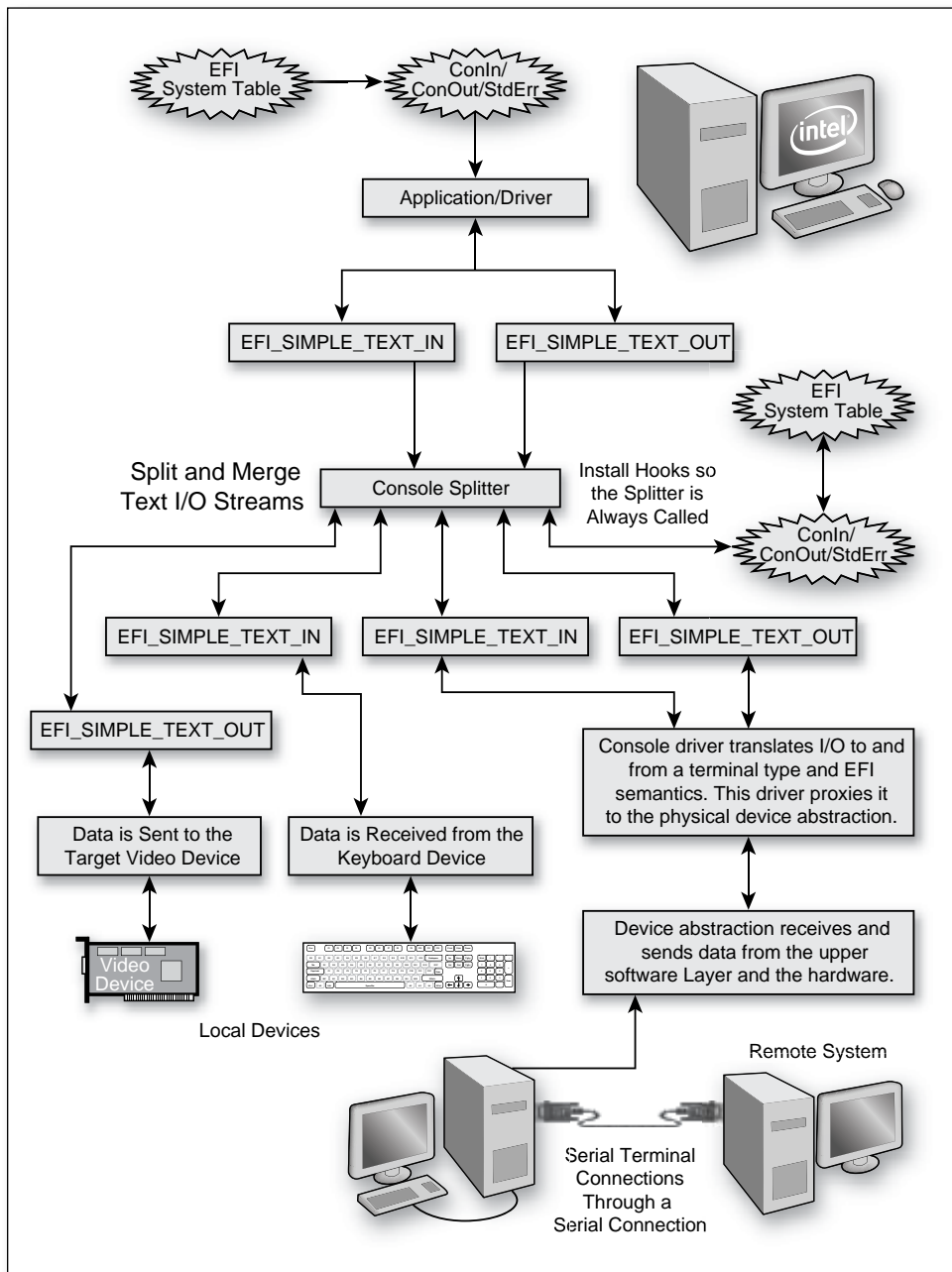

Figure 6.4 Software Layering Description of the UEFI Console Splitter

Network Consoles

UEFI also provides the ability to establish data connections with remote platforms across a network. Given the appropriate installed drivers, one could also enable a UEFI-compliant platform to support a text I/O set of abstractions. Similar to previously discussed concepts where the hardware interface (for example, serial device, keyboard, video, network interface card) has an abstraction, other components build on top of this hardware abstraction to provide a working software stack.

Some network components that UEFI might include are as follows:

- **Network Interface Identifier** – This is an optional protocol that is produced by the Universal Network Driver Interface (UNDI) and is used to produce the Simple Network Protocol. This protocol is only required if the underlying network interface is a 16-bit UNDI, 32/64-bit software UNDI, or hardware UNDI. It is used to obtain type and revision information about the underlying network interface.
- **Simple Network Protocol** – This protocol provides a packet level interface to a network adapter. It in addition provides services to initialize a network interface, transmit packets, receive packets, and close a network interface.

To illustrate what a common network console might look like, you could describe an initial hardware abstraction that talks directly to the network interface controller (NIC) produced by an UNDI driver. This in turn has a Simple Network Protocol that layers on top of UNDI. It provides basic network abstraction interfaces such as Send and Receive. On top of this a transport protocol might be installed such as a TCP/IP stack. As with most systems, once an established transport mechanism is provided, one can build all sorts of extensions into the platform such as a Telnet daemon to allow remote users to log into the system through a network connection. Ultimately, this daemon would produce and be responsible for handling the normal Text I/O interfaces already described in this chapter.

Figure 6.5 illustrates an example where a remote machine is able to access the EFI-compliant platform through a network connection. Providing the top layer of the software stack (EFI_SIMPLE_TEXT_IN and EFI_SIMPLE_TEXT_OUT) as the interoperable surface area that applications talk to allows for all standard UEFI applications to seamlessly leverage the console support

in a platform. Couple this with console splitting and merging as inherent capabilities and you have the ability to interact with the platform in a much more robust manner without requiring a lot of specially tuned software to enable it.

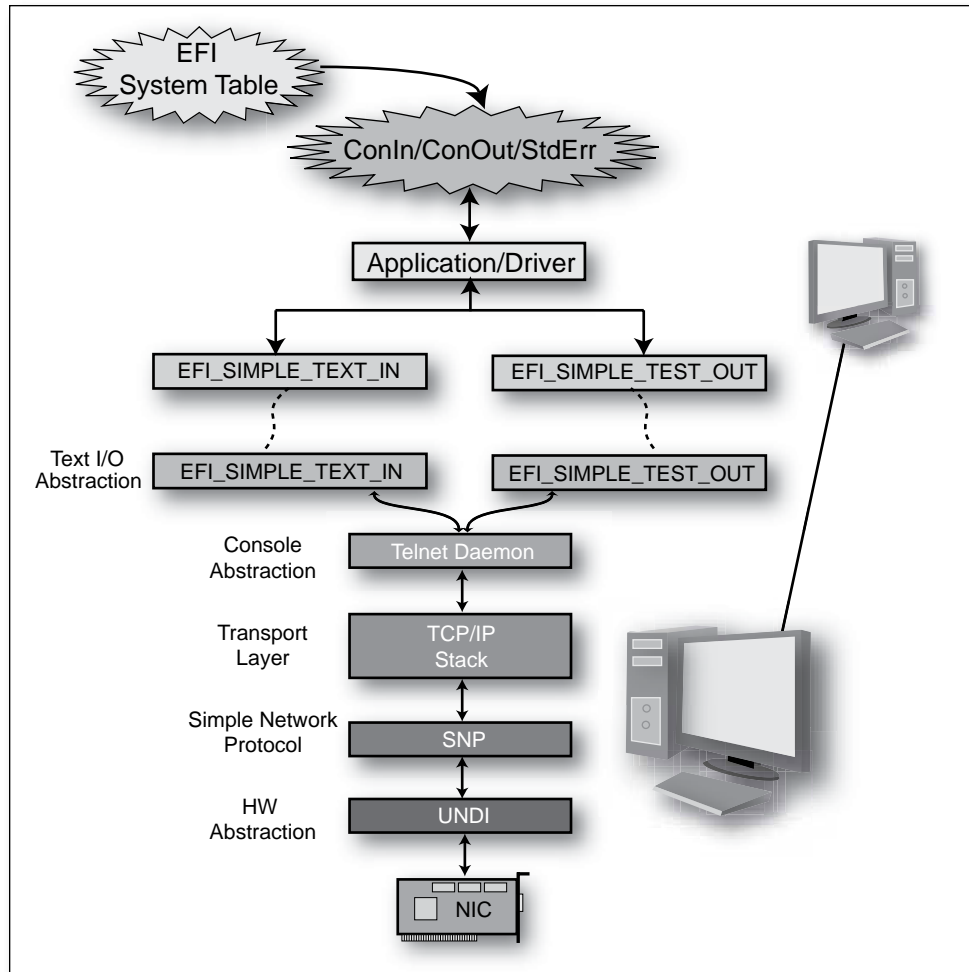

Figure 6.5 Example of Network Console Software Layering

Summary

In conclusion, UEFI provides a very robust means of describing the various possible input and output console possibilities. It can also support console representations through a gamut of protocols such as terminal emulators (such as ANSI/VT100) as well as remote network consoles leveraging wider variations of the underlying UEFI network stack.

Chapter 7

Different Types of Platforms

Variety's the very spice of life, That gives it all its flavor.

—William Cowper

This chapter describes different platform types and instantiations of the Platform Initialization (PI), such as embedded system, laptop, smart phone, netbook, tablet, PDA, desktop, and server. In addition to providing a “BIOS replacement” for platforms that are commonly referred to as the Personal Computer, the PI infrastructure can be used to construct a boot and initialization environment for servers, handheld devices, televisions, and so on. These sundry devices may include the more common IA-32 processors in the PC, but also feature the lower-power Intel® Atom™ processor, or the mainframe-class processors such as the Itanium®-based systems. This chapter examines the PEI modules and DXE drivers that are necessary to construct a standard PC platform. Then a subset of these modules used for emulation and Intel Atom-based netbooks and smart phones is described.

Figure 7.1 is a block diagram of a typical system, showing the various components, integrating the CPU package, south bridge, and super I/O, beyond other possible components. These blocks represent components manufactured on the system board. Each silicon and platform component will have an associated module or driver to handle the respective initialization. In addition to the components on the system board, the initial system address map of the platform has specific region allocations. Figure 7.2 shows the system address map of the PC platform, including memory allocation. The

system flash in this platform configuration is 1 megabyte in size. The system flash appears at the upper end of the 32-bit address space in order to allow the Intel® Core i7™ processor to fetch the first opcodes from flash upon reset. The reset vector lies 16 bytes from the end of the address space. In the SEC, the initial opcodes of the SEC file allow for initial control flow of the PI-based platform firmware. From the SEC a collection of additional modules are executed. The Intel Core i7 processor has both the central processing unit (CPU), or *core*, and portions of the chipset, or *uncore*. The latter elements include the integrated memory controller (IMC) and the system bridge, such as to PCI.

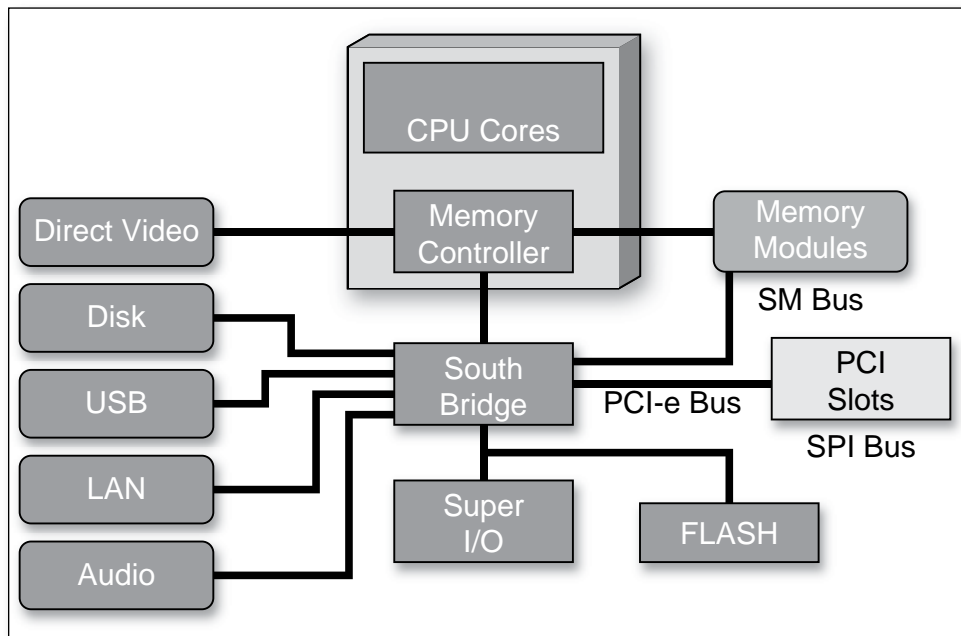
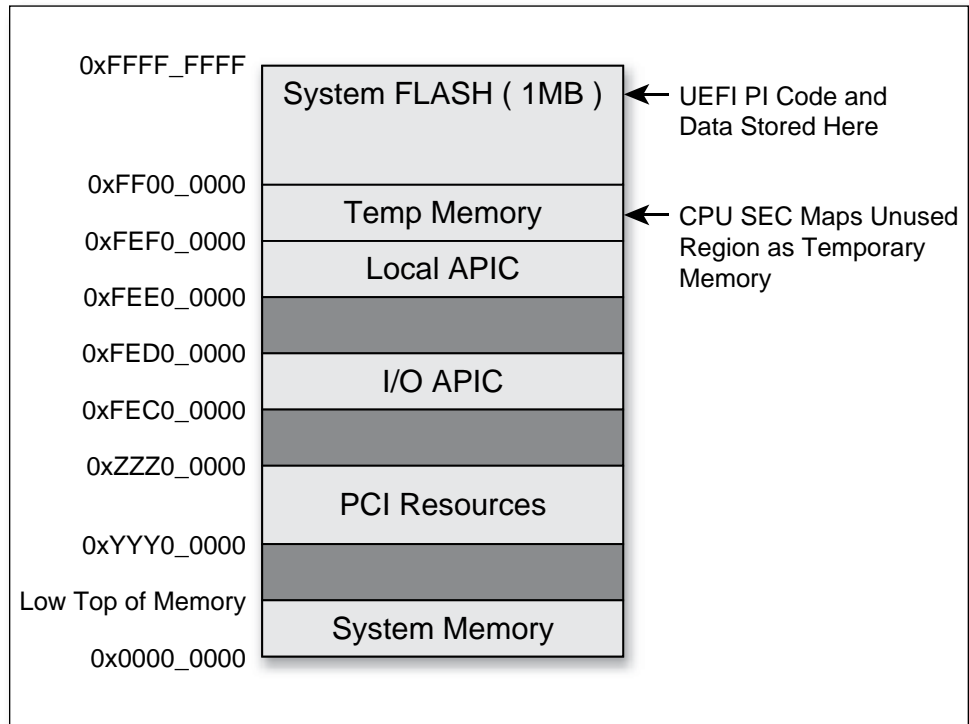

Figure 7.1 Typical PC System

**Figure 7.2** System Address Map

Before going through the various components of the PC firmware load, a few other platforms will be reviewed. These include the wireless personal digital assistant, which can be a low-power x64 or IA-32 CPU or an Intel Atom processor/system-on-a-chip (SoC). The platforms then scale up to a server. This is shown in Figure 7.3.

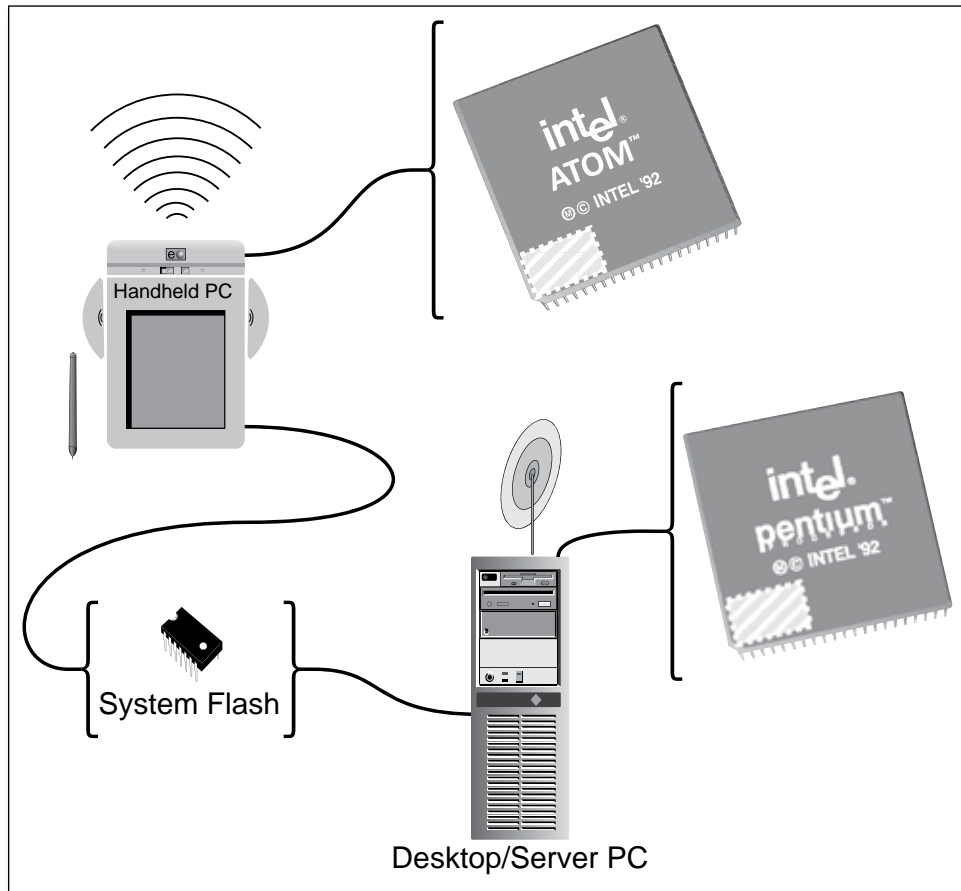

Figure 7.3 Span of Systems

Figure 7.4 shows a series of non-PCs, such as tablets and smart phones. The former includes a touch screen and integrated peripherals, such as 3G, Wi-Fi† and LTE/WiMAX† radios. The latter devices, namely the smart phones, are highly integrated devices with GPS, several radios, touch screens, accelerometers, and some NAND storage. Within all of these devices, an Intel

Atom-based system on a chip and a specific collection of PEI modules (PEIMs) and DXE drivers execute to initialize the local hardware complex. Then the DXE-based UEFI core would boot a UEFI-aware version of an embedded operating system, such as MeeGo[†] or VxWorks[†]. This demonstrates how the platform concept can span many different topologies. These topologies include the classical, open-architecture PC and the headless, closed embedded system of an I/O board.



Figure 7.4 An Intel® Atom™-based System

Now let's examine the components for the PC in Figure 7.1 in greater detail. The PEI phase of execution runs immediately after a restart event, such as a power-on reset, resume from hibernate, and so on. The PEI modules execute in place from the flash store, at least until the main memory complex (such as DRAM) has been initialized.

Figure 7.5 displays the collection of PEIMs for the PC platform. Different business interests would supply the modules. For example, in the platform codenamed Lakeport, Intel would provide the Intel® Core™ i7 CPU with an integrated Memory Controller Hub Memory Controller PEIM and the PCH (Platform Controller Hub) PEIM. The PCH is also known as the “South Bridge.” In addition, for the SMBUS (System management bus) attached to the PCH, there would be a PCH-specific SMBUS PEIM. The status code PEIM would describe a platform-specific means by which to emit debug information, such as an 8-bit code emitted to I/O port 80-hex.

Intel CPU Core PEIM	Generic	Init and CPU I/O
DXE IPL PEIM	Generic	Starts DXE Foundation
PCI Configuration PEIM	PCAT	Uses I/O 0xCF8, 0xCFC
Stall PEIM	PCAT	Uses 8254 Timer
Status Code PEIM	Platform	Debug Messages
SMBUS PEIM	South Bridge	SMBUS Transactions
Memory Controller PEIMs	Uncore	Read SPD, Init Memory
Motherboard PEIM	Platform	FLASH Map, Boot Policy

Figure 7.5 Components of PEI on PC

The SMBUS PEIM for the PCH listed in Figure 7.5 provides a standard interface, or PEIM-to-PEIM interface (PPI), as shown in Figure 7.6. This allows the memory controller PEIM to use the SMBUS read command in order to get information regarding the dual-inline memory module (DIMM) Serial Presence Detect (SPD) data on the memory. The SPD data includes the size, timing, and other details about the memory modules. The memory initialization PEIM will use the `EFI_PEI_SMBUS_PPI` so that the GMCH-specific memory initialization module does not need to know which component provides the SMBUS capability. In fact, many integrated super I/O (SIO) components also provide an SMBUS controller, so this platform could have replaced the PCH SMBUS PEIM with an SIO SMBUS PEIM without having to modify the memory controller PEIM.

```

typedef
EFI_STATUS
(EFIAPI *PEI_SMBUS_PPI_EXECUTE_OPERATION) (
    IN      EFI_PEI_SERVICE          **PeiServices,
    IN      struct EFI_PEI_SMBUS_PPI *This,
    IN      EFI_SMBUS_DEVICE_ADDRESS SlaveAddress,
    IN      EFI_SMBUS_DEVICE_COMMAND Command,
    IN      EFI_SMBUS_OPERATION      Operation,
    IN      BOOLEAN                   PecCheck,
    IN OUT  UINTN                     *Length,
    IN OUT  VOID                      *Buffer
);

typedef struct {
    PEI_SMBUS_PPI_EXECUTE_OPERATION  Execute;
    PEI_SMBUS_PPI_ARP_DEVICE         ArpDevice;
} EFI_PEI_SMBUS_PPI;

```

Figure 7.6 Code Fragment for a PEIM PPI

Many implementations are possible beyond the `EFI_PEI_SMBUS_PPI` shown earlier. Figure 7.7 shows a code fragment that implements the SMBUS read operation for the PCH component listed earlier. Note the use of the CPU I/O abstraction for performing the I/O operations against the PCH component. The fact that the logic is written in C means that this same PCH on an Intel Atom or Itanium-based system could reuse the same source code through a simple compilation for the target microarchitecture.

```
#define SMBUS_R_HD0 0xEFA5
#define SMBUS_R_HBD 0xEFA7

EFI_PEI_SERVICES          *PeiServices;
SMBUS_PRIVATE_DATA       *Private;?
UINT8  Index, BlockCount *Length;
UINT8                                     *Buffer;

BlockCount = Private->CpuIo.IoRead8 (
    *PeiServices,Private->CpuIo,SMBUS_R_HD0);
if (*Length < BlockCount) {
    return EFI_BUFFER_TOO_SMALL;
} else {
    for (Index = 0; Index < BlockCount; Index++) {
        Buffer[Index] = Private->CpuIo.IoRead8 (
            *PeiServices,Private->CpuIo,SMBUS_R_HBD);
    }
}
```

Figure 7.7 Code Fragment of PEIM Implementation

Beyond the PEI phase, the DXE core requires a series of platform-, CPU-, and chipset-specific drivers in order to provide a fully-instantiated set of DXE/EFI services. Figure 7.8 lists the collection of architectural protocols that are necessary for the PC platform under study.

Watchdog	Generic	Uses Timer-based Events
Monotonic Counter	Generic	Uses Variable Services
Runtime	Generic	Platform Independent
CPU	Generic	Pentium 4 DXE Driver
BDS	Generic	Use Sample One for Now
Timer	PCAT	Uses 8254 Timer
Metronome	PCAT	Uses 8254 Timer
Reset	PCAT	I/O 0xCF9
Real Time Clock	PCAT	I/O 0x70-0x71
Security	Platform	Platform Specific Authentication
Status Code	Platform	Debug Messages
Variable	Platform	Depends on FLASH Map

Figure 7.8 Architectural Protocols

The fact that the DXE Foundation does not presume anything about the timekeeping logic, interrupt controller, instruction set, and so on, means that the DXE Foundation C code can be retargeted for a large class of platforms without reengineering the Foundation code itself. Instead, a different collection of the architectural protocols (APs) can affect the Foundation port.

One aspect of the system that needs to be abstracted is the management of time. The timekeeping hardware on a PC/AT compatible chipset, such as the 8254 timer, differs from the CPU-integrated timer-counter (ITC) on the Itanium processor or the timekeeping logic specific to the Intel Atom processor. As such, in order to have a single implementation of the DXE Foundation watchdog-timer logic, the access to CPU/chipset-specific timing hardware is implemented via the Timer Architectural Protocol. This AP has a series of services, such as getting and setting the time period. The setting of the time period will be reviewed across our reference class of platforms.

To begin, Figure 7.9 provides an instance of the set timer service for the NT32 platform. NT32 is a virtual PI platform that executes upon a 32-bit Microsoft Windows system as a user-mode process. It is a “soft” platform in that the platform capabilities are abstracted through Win32 services. As such, the implementation of this AP service doesn’t access an I/O controller or chipset control/status registers. Instead, the AP invokes a series of Win32 services to provide mutual exclusion and an operating system thread to emulate the timer action.

```

EFI_STATUS
TimerDriverSetTimerPeriod (
    IN EFI_TIMER_ARCH_PROTOCOL *This,
    IN UINT64                    TimerPeriod
)
{
    . . .
    gWinNt->EnterCriticalSection (&mNtCriticalSection);
    mTimerPeriod = TimerPeriod;
    mCancelTimerThread = FALSE;
    gWinNt->LeaveCriticalSection (&mNtCriticalSection);
    mNtLastTick = gWinNt->GetTickCount ();
    mNtTimerThreadHandle = gWinNt->CreateThread (
                                                NULL,
                                                0,
                                                NtTimerThread,
                                                &mTimer,
                                                0,
                                                &NtThreadId);
    . . .
}

```

Figure 7.9 NT32 Architectural Protocol

The NT32 implementation is radically different from a bare-metal PI implementation. An instance of a hardware implementation can be found in Figure 7.10. Herein the memory-mapped registers of an Intel Atom system on a chip are accessed by the same AP set timer interface. The DXE Foundation cannot discern the difference between the virtual NT32 platform service and the actual hardware instance for an Intel Atom processor.

```

EFI_STATUS
TimerDriverSetTimerPeriod (
    IN EFI_TIMER_ARCH_PROTOCOL *This,
    IN UINT64                    TimerPeriod
)
{
    UINT64  Count;
    UINT32  Data;
    . . .
    Count = DivU64x32 (MultU64x32 (TimerPeriod, OST_CRYSTAL_FREQ) + 5000000,
                      10000000, NULL);
    mCpuIo->Mem.Read (mCpuIo, EfiWidthUint32, OSCR_BASE_PHYSICAL, 1, &Data);
    Data += (UINT32)Count;
    mCpuIo->Mem.Write (mCpuIo, EfiWidthUint32, OSMR0_BASE_PHYSICAL, 1, &Data);
    mCpuIo->Mem.Read (mCpuIo, EfiWidthUint32, OIER_BASE_PHYSICAL, 1, &Data);
    Data |= (UINT32)1;
    mCpuIo->Mem.Write (mCpuIo, EfiWidthUint32, OIER_BASE_PHYSICAL, 1, &Data);
    mCpuIo->Mem.Read (mCpuIo, EfiWidthUint32, ICMR_PHYSICAL, 1, &Data);
    Data |= (UINT32)(1 << SA_OST0_IRQ_No);
    mCpuIo->Mem.Write (mCpuIo, EfiWidthUint32, ICMR_PHYSICAL, 1, &Data);
    . . .
}

```

Figure 7.10 AP from Intel® Atom™

Finally, for the PC/AT and the circa mid-1980s ISA I/O hardware, there is an additional implementation of the AP service. Figure 7.11 shows the same set timer service when accessing the 8254 timer-counter and then registering an interrupt with the 8259 Programmable Interrupt Controller (PIC). This is often referred to as a PC/AT version of the AP since all PCs since the PC-XT have supported these hardware interfaces. For the PC example in this chapter, these ISA I/O resources are supported by the PCH component, versus discrete components in the original PC.

```

EFI_STATUS
TimerDriverSetTimerPeriod (
    IN EFI_TIMER_ARCH_PROTOCOL *This,
    IN UINT64                    TimerPeriod
)
{
    UINT64  Count;
    UINT8   Data;
    . . .
    Count = DivU64x32 (MultU64x32(119318, (UINTN) TimerPeriod) + 500000,
                      1000000, NULL);

    Data = 0x36;
    mCpuIo->Io.Write(mCpuIo,EfiCpuIoWidthUint8,TIMER_CONTROL_PORT, 1, &Data);
    mCpuIo->Io.Write(mCpuIo,EfiCpuIoWidthFifoUint8,TIMER0_COUNT_PORT,2,&Count);
    mLegacy8259->EnableIrq (mLegacy8259, Efi8259Irq0, FALSE);
    . . .
}

```

Figure 7.11 AP for PC/AT

Beyond the many implementation options for an AP to provide the breadth of platform porting, additional capabilities in DXE support various platform targets. In UEFI, the interaction with the platform occurs through the input and output console services. The console input for a PC is typically a PS/2 or USB keyboard, and the output is a VGA or enhanced video display. But the I/O card studied earlier has no traditional “head” or display. These deeply embedded platforms may only have a simple serial interface to the system. Interestingly, the same PC hardware can also run without a traditional display and interact with the user via a simple serial interface. Figure 7.12 displays a console stack for a UEFI system built upon a serial interface.

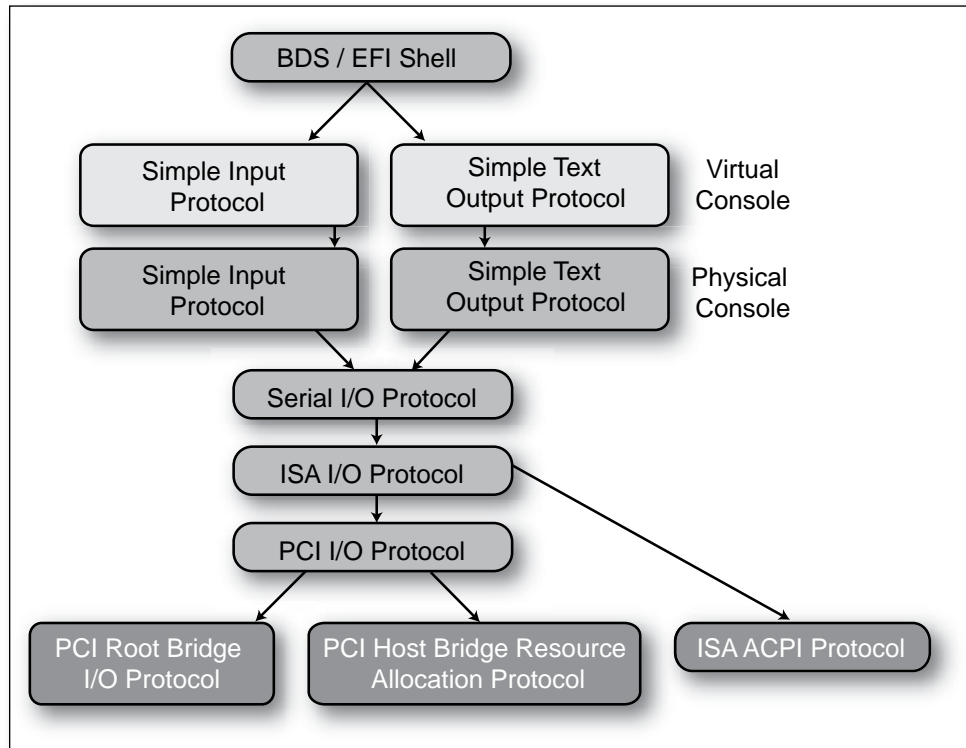

Figure 7.12 Console Stack on a PC

In order to build out this stack, the boot-device selection (BDS) or the UEFI shell provides an application or command line interface (CLI) to the user. The Simple Input and output protocols are published via a console driver that layers upon the Serial I/O protocol. For the PCI-based PC, a PCI root bridge protocol allows access to the serial port control and status registers; for the Intel Atom platform with an internally-integrated UART/serial port, an alternate low-level protocol may exist to access these same registers.

For this platform layering, the components listed in Figure 7.13 describe the DXE and UEFI components needed to build out this console stack. Just as in the case of the PEI modules, different interests can deliver the DXE and UEFI drivers. For example, the Super I/O vendor may deliver the ISA ACPI driver, the silicon vendor PCI root bridge (such as the GMCH in this PC), a platform console driver, and then a set of reusable components based upon the PC/AT ISA hardware.

BDS / EFI Shell	Generic	
Console Splitter	Generic	
Terminal	Generic	
ISA Serial	PCAT	
ISA Bus	Generic	
PCI Bus	Generic	
Console Platform	Platform	Platform Specific Policy
PCI Root Bridge	Uncore	Work with Chipset Vendor
PCI Host Bridge	Uncore	Work with Chipset Vendor
ISA ACPI	Super I/O	Work with Super I/O Vendor

Figure 7.13 Components for Console Stack

Beyond the console components, several other PEI modules and DXE components need to be included into the firmware volume. These other components, listed in Figure 7.14, provide for other capabilities. These include the platform-specific means by which to store UEFI variables, platform policy for security, and configuration.

Status Code	PEI	Platform
Memory Controller	PEI	North Bridge
SMBUS	PEI	South Bridge
Motherboard	PEI	Platform
Security	DXE	Platform
Status Code	DXE	Platform
Variable	DXE	Platform
Console Platform	DXE	Platform
PCI Root Bridge	DXE	Uncore
PCI Host Bridge	DXE	Uncore
ISA ACPI	DXE	Super I/O

Figure 7.14 DXE Drivers on a PC

The UEFI variables can be stored in various regions of the flash part (or a service processor on a server), so a driver needs to abstract this store. For security, the vendor may demand that field component updates be signed or that modules dispatched be hash-extended into a Trusted Platform Module (TPM). The security driver will abstract these security capabilities.

A final feature to describe the component layering of DXE drivers is support for the disk subsystem, namely the Integrated Device Electronics (IDE) and a UEFI file system. The protocol layering for the disk subsystem up to the file system instance are shown in Figure 7.15.

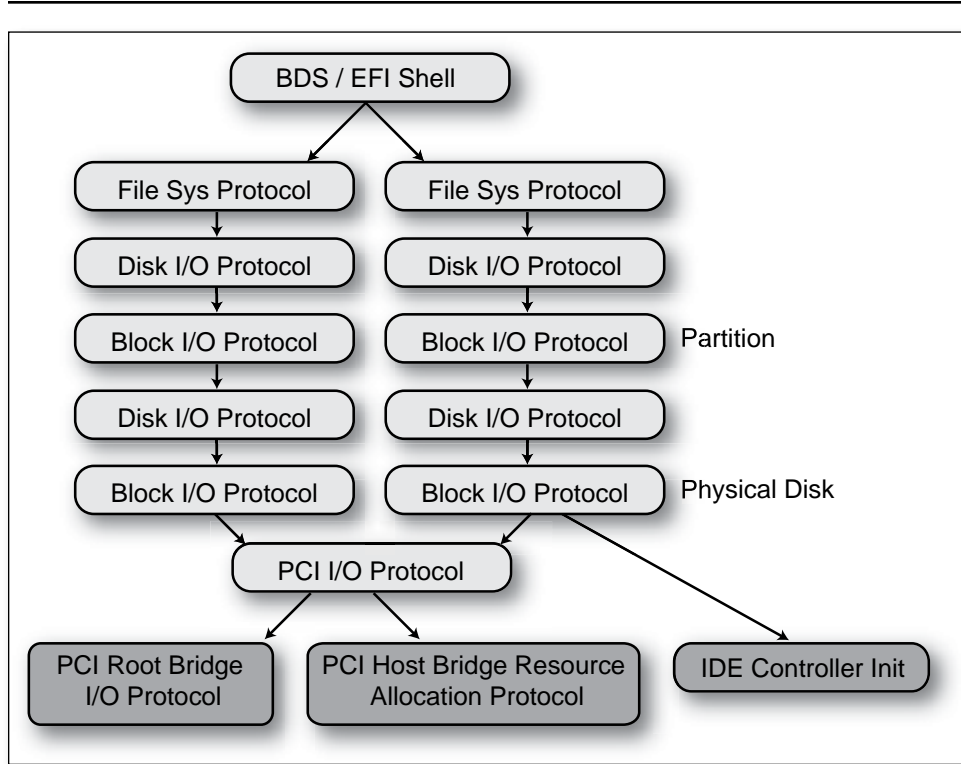

Figure 7.15 IDE Stack

The same UEFI shell or BDS resides at the top of the protocol layering. Instances of the simple file system (FS) protocol provide the read/write/open/close capability to applications. The FS protocols layer atop disk I/O protocol. A disk I/O provides byte-level access to a sector-oriented block device. As such, disk I/O is a software-only driver that provides this mapping from hardware-specific block I/O abstractions. The disk I/O layer binds to a series of block I/O instances. The block I/O protocol is published by the block device interest, such as the PCH driver in DXE that abstracts the Serial AT-Attachment (SATA) disk controller in the PCH. The disk driver uses the PCI Block I/O protocol to access the control and status registers in the PCH component.

The components that provide these capabilities in the file system stack can be found in Figure 7.16. The file system components include the File Allocation Table (FAT) driver, a driver that provides FAT12/16/32 support. FAT is the original file system for MS-DOS on the original PC that has been

extended over time, culminating in the 32-bit evolution of FAT in Windows95 as FAT32. In addition, providing different performance options of the storage channel can be abstracted via the IDE Controller Initialization component. This provides an API so that a platform setup/configuration program or diagnostic can change the PCH settings of this feature.

BDS / EFI Shell	Generic	
FAT	Generic	
Partition	Generic	
Disk I/O	Generic	
IDE Bus	PCAT	
PCI Bus	Generic	
PCI Root Bridge	Uncore	
PCI Host Bridge	Uncore	
IDE Controller Init	South Bridge	IDE Channel Attributes

Figure 7.16 Components for IDE Init

This same console stack for the serial port and file system stack for the SATA controller only depends upon the PCH components, a PCI abstraction, and appropriate support components. As such, putting this same PCH, or a logically-equivalent version of this chip integrated into another application-specific integrated circuit (ASIC), will admit reuse of these same binaries on other like systems (such as an x64 desktop to an x64 server). Beyond this binary reuse across IA32 and x64 platform classes, the C code allows for reuse. The use of this PCH, whether the literal component or the aforementioned logical integration, on the Itanium Processor, can occur via a recompilation of the component C code with the Itanium Processor as the target for the binary.

Summary

This chapter has provided an overview of some platforms that are based upon UEFI and PI firmware technology. The power of the abstractions of the interfaces comes into play as the firmware can be implemented on a PC/AT system, Itanium, and non-PC/AT system on a chip (SoC). In addition to the portability of the abstractions, this chapter has also shown how various modules are integrated in order to provide a full console and storage stack. It is through these detailed platform realizations that the composition of the industry APIs and their interoperation comes into light.

DXE Basics: Core, Dispatching, and Drivers

I do not fear computers. I fear the lack of them.

—Isaac Asimov

This chapter describes the makeup of the Driver Execution Environment (DXE) and how it operates during the platform evolution. In addition, it describes some of the fundamental concepts of how information is handed off between phases of the platform boot process and how the underlying components are launched. The launching description also provides some insight into how launch orders are constructed, since they do deviate from what is commonly referred to as POST tables in legacy firmware.

The DXE phase contains an implementation of UEFI that is compliant with the PI (Platform Initialization) *Specification*. As a result, both the DXE Core and DXE drivers share many of the attributes of UEFI images. The DXE phase is the phase where most of the system initialization is performed. The Pre-EFI Initialization (PEI) phase is responsible for initializing permanent memory in the platform so the DXE phase can be loaded and executed. The state of the system at the end of the PEI phase is passed to the DXE phase through a list of position-independent data structures called Hand-Off Blocks (HOBs). The DXE phase consists of several components:

- DXE Core
- DXE Dispatcher
- DXE Drivers

The DXE Core produces a set of Boot Services, Runtime Services, and DXE Services. The DXE Dispatcher is responsible for discovering and executing DXE drivers in the correct order. The DXE drivers are responsible for initializing the processor, chipset, and platform components as well as providing software abstractions for console and boot devices. These components work together to initialize the platform and provide the services required to boot an OS. The DXE and Boot Device Selection (BDS) phases work together to establish consoles and attempt the booting of operating systems. The DXE phase is terminated when an OS successfully begins its boot process—that is, when the BDS phase starts. Only the runtime services provided by the DXE Core and services provided by runtime DXE drivers are allowed to persist into the OS runtime environment. The result of DXE is the presentation of a fully formed UEFI interface.

Figure 8.1 shows the phases that a platform with UEFI compatible firmware goes through on a cold boot. This chapter covers the following:

- Transition from the PEI to the DXE phase
- The DXE phase
- The DXE phase's interaction with the BDS phase

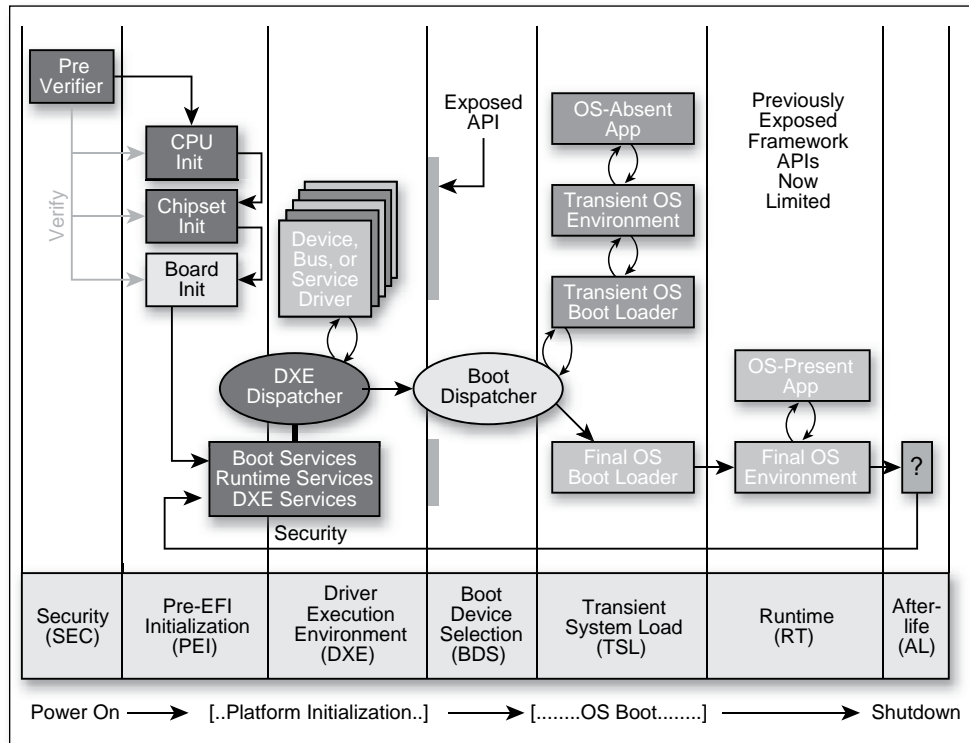

Figure 8.1 Platform Boot Phases

DXE Core

The DXE Core is designed to be completely portable with no processor, chipset, or platform dependencies. This portability is accomplished by incorporating several features:

- The DXE Core depends only upon a HOB list for its initial state. This single dependency means that the DXE Core does not depend on any services from a previous phase, so all the prior phases can be unloaded once the HOB list is passed to the DXE Core.
- The DXE Core does not contain any hard-coded addresses. As a result, the DXE Core can be loaded anywhere in physical memory, and it

can function correctly no matter where physical memory or where firmware volumes are located in the processor's physical address space.

- The DXE Core does not contain any processor-specific, chipset-specific, or platform-specific information. Instead, the DXE Core is abstracted from the system hardware through a set of architectural protocol interfaces. These architectural protocol interfaces are produced by a set of DXE drivers that are invoked by the DXE Dispatcher.

Below is an illustration which shows how data is handed off between the PEI and DXE phases.

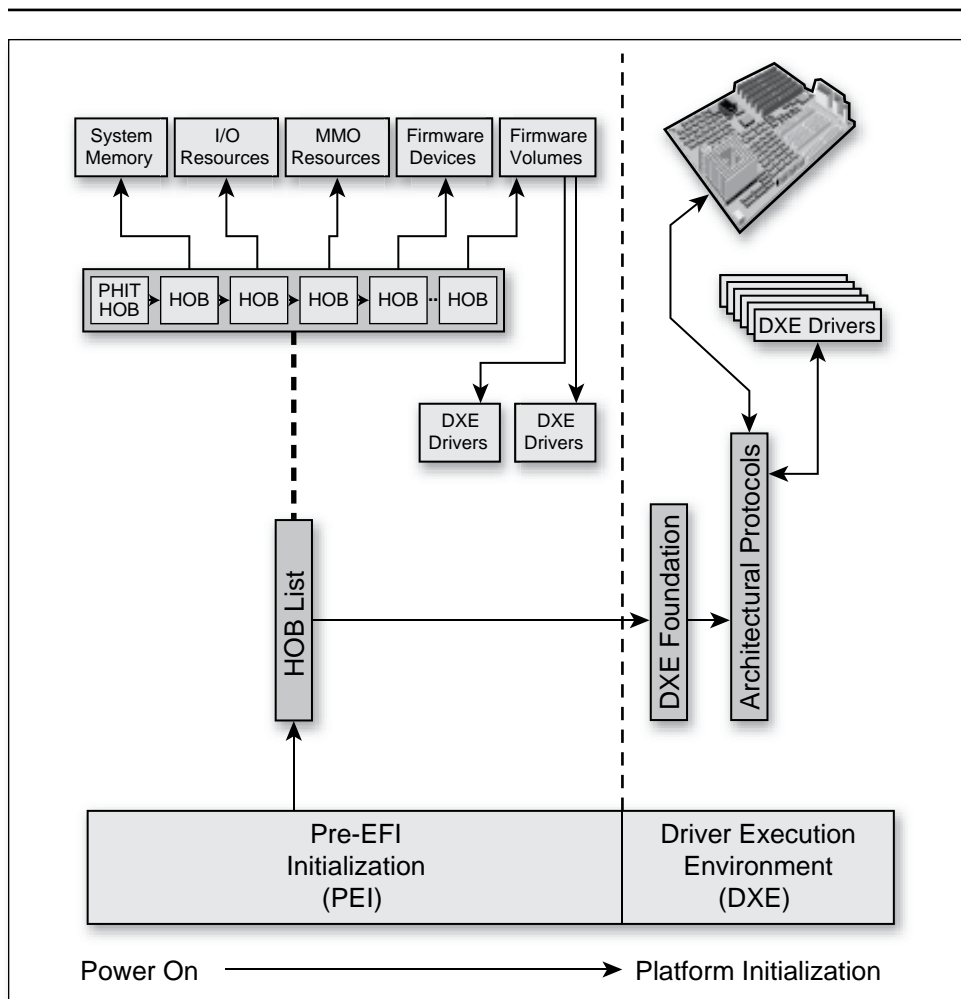

Figure 8.2 Early Initialization Illustrating a Handoff between PEI and DXE

The DXE Core produces the EFI System Table and its associated set of EFI Boot Services and EFI Runtime Services. The DXE Core also contains the DXE Dispatcher, whose main purpose is to discover and execute DXE drivers stored in firmware volumes. The order in which DXE drivers are executed is determined by a combination of the optional a priori file (see the section on the DXE dispatcher) and the set of dependency expressions that are associated with the DXE drivers. The firmware volume file format allows dependency expressions to be packaged with the executable DXE driver image. DXE drivers utilize a PE/COFF image format, so the DXE Dispatcher must also contain a PE/COFF loader to load and execute DXE drivers.

The DXE Core must also maintain a handle database. A handle database is a list of one or more handles, and a handle is a list of one or more unique protocol GUIDs. A protocol is a software abstraction for a set of services. Some protocols abstract I/O devices, and other protocols abstract a common set of system services. A protocol typically contains a set of APIs and some number of data fields. Every protocol is named by a GUID, and the DXE Core produces services that allow protocols to be registered in the handle database. As the DXE Dispatcher executes DXE drivers, additional protocols are added to the handle database including the DXE Architectural Protocols that are used to abstract the DXE Core from platform-specific details.

Hand-Off Block (HOB) List

The HOB list contains all the information that the DXE Core requires to produce its memory-based services. The HOB list contains information on the boot mode, the processor's instruction set, and the memory that was discovered in the PEI phase. It also contains a description of the system memory that was initialized by the PEI phase, along with information about the firmware devices that were discovered in the PEI phase. The firmware device information includes the system memory locations of the firmware devices and of the firmware volumes that are contained within those firmware devices. The firmware volumes may contain DXE drivers, and the DXE Dispatcher is responsible for loading and executing the DXE drivers that are discovered in those firmware volumes. Finally, the HOB list may contain the I/O resources and memory-mapped I/O resources that were discovered in the PEI phase.

Figure 8.3 shows an example HOB list. The first entry in the HOB list is always the Phase Handoff Information Table (PHIT) HOB that contains the boot mode. The rest of the HOB list entries can appear in any order. This

example shows the different types of system resources that can be described in a HOB list. The most important ones to the DXE Core are the HOBs that describe system memory and the HOBs that describe firmware volumes. A HOB list is always terminated by an end-of-list HOB. The one additional HOB type that is not shown in Figure 8.3 is the GUID extension HOB that allows a PEIM to pass private data to a DXE driver. Only the DXE driver that recognizes the GUID value in the GUID extension HOB can understand the data in that HOB. The HOB entries are all designed to be position-independent. This independence allows the DXE Core to relocate the HOB list to a different location if it is not suitable to the DXE Core.

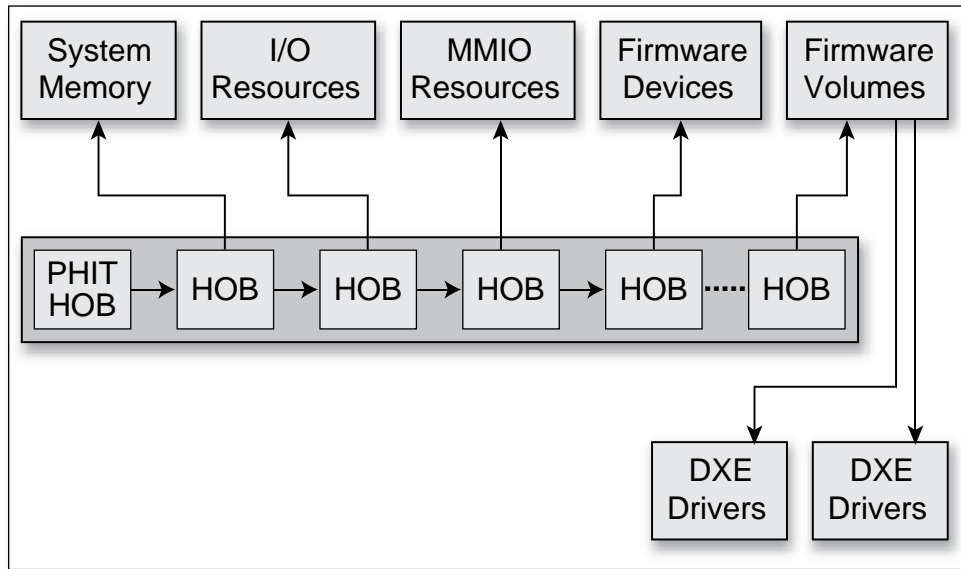

Figure 8.3 HOB List

DXE Architectural Protocols

The DXE Core is abstracted from the platform hardware through a set of DXE Architectural Protocols. The DXE Core consumes these protocols to produce the EFI Boot Services and EFI Runtime Services. DXE drivers that are loaded from firmware volumes produce the DXE Architectural Protocols. This design means that the DXE Core must have enough services to load and start DXE drivers before even a single DXE driver is executed.

The DXE Core is passed a HOB list that must contain a description of some amount of system memory and at least one firmware volume. The system memory descriptors in the HOB list are used to initialize the UEFI services that require only memory to function correctly. The system is also guaranteed to be running on only one processor in flat physical mode with interrupts disabled. The firmware volume is passed to the DXE Dispatcher, which must contain a read-only FFS driver to search for the *a priori* file and any DXE drivers in the firmware volumes. When a driver is discovered that needs to be loaded and executed, the DXE Dispatcher uses a PE/COFF loader to load and invoke the DXE driver. The early DXE drivers produce the DXE Architectural Protocols, so the DXE Core can produce the full complement of EFI Boot Services and EFI Runtime Services. Figure 8.4 shows the HOB list being passed to the DXE Core. The DXE Core consumes the services of the DXE Architectural Protocols shown in the figure and then produces the EFI System Table, EFI Boot Services Table, and the EFI Runtime Services Table.

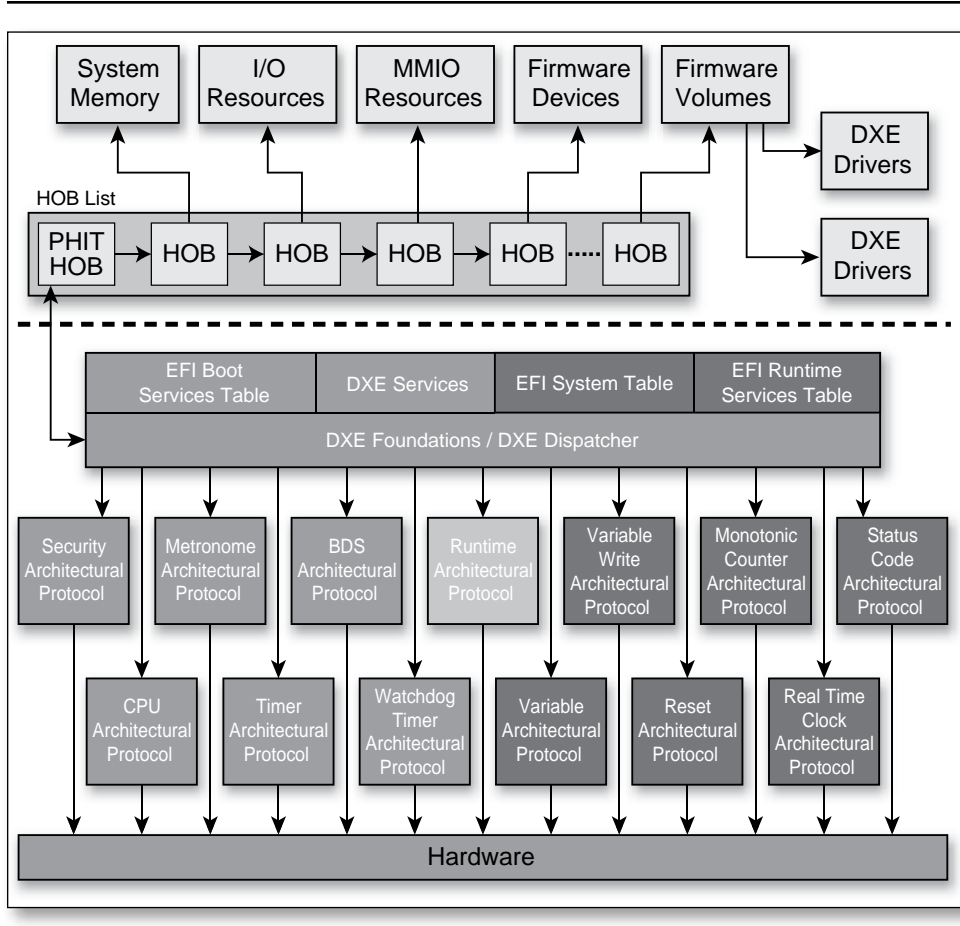

Figure 8.4 DXE Architectural Protocols

Figure 8.4 shows all the major components present in the DXE phase. The EFI Boot Services Table and DXE Services Table shown on the left are allocated from UEFI boot services memory. This allocation means that the EFI Boot Services Table and DXE Services Table are freed when the OS runtime phase is entered. The EFI System Table and EFI Runtime Services Table on the right are allocated from EFI Runtime Services memory, and they do persist into the OS runtime phase.

The DXE Architectural Protocols shown on the left in Figure 8.4 are used to produce the EFI Boot Services. The DXE Core, DXE Dispatcher, and the protocols shown on the left are freed when the system transitions to the OS runtime phase. The DXE Architectural Protocols shown on the right are

used to produce the EFI Runtime Services. These services persist in the OS runtime phase. The Runtime Architectural Protocol in the middle is special. This protocol provides the services that are required to transition the runtime services from physical mode to virtual mode under the direction of an OS. Once this transition is complete, these services can no longer be used.

The following is a brief summary of the DXE Architectural Protocols:

- Security Architectural Protocol: Allows the DXE Core to authenticate files stored in firmware volumes before they are used.
- CPU Architectural Protocol: Provides services to manage caches, manage interrupts, retrieve the processor's frequency, and query any processor-based timers.
- Metronome Architectural Protocol: Provides the services required to perform very short calibrated stalls.
- Timer Architectural Protocol: Provides the services required to install and enable the heartbeat timer interrupt required by the timer services in the DXE Core.
- BDS Architectural Protocol: Provides an entry point that the DXE Core calls once after all of the DXE drivers have been dispatched from all of the firmware volumes. This entry point is the transition from the DXE phase to the BDS phase, and it is responsible for establishing consoles and enabling the boot devices required to boot an OS.
- Watchdog Timer Architectural Protocol: Provides the services required to enable and disable a watchdog timer in the platform.
- Runtime Architectural Protocol: Provides the services required to convert all runtime services and runtime drivers from physical mappings to virtual mappings.
- Variable Architectural Protocol: Provides the services to retrieve environment variables and set volatile environment variables.

- Variable Write Architectural Protocol: Provides the services to set nonvolatile environment variables.
- Monotonic Counter Architectural Protocol: Provides the services required by the DXE Core to manage a 64-bit monotonic counter.
- Reset Architectural Protocol: Provides the services required to reset or shut down the platform.
- Status Code Architectural Protocol: Provides the services to send status codes from the DXE Core or DXE drivers to a log or device.
- Real Time Clock Architectural Protocol: Provides the services to retrieve and set the current time and date as well as the time and date of an optional wakeup timer.

EFI System Table

The DXE Core produces the EFI System Table, which is consumed by every DXE driver and executable image invoked by BDS. It contains all the information that is required for these components to use the services provided by the DXE Core and any previously loaded DXE driver. Figure 8.5 shows the various components that are available through the EFI System Table.

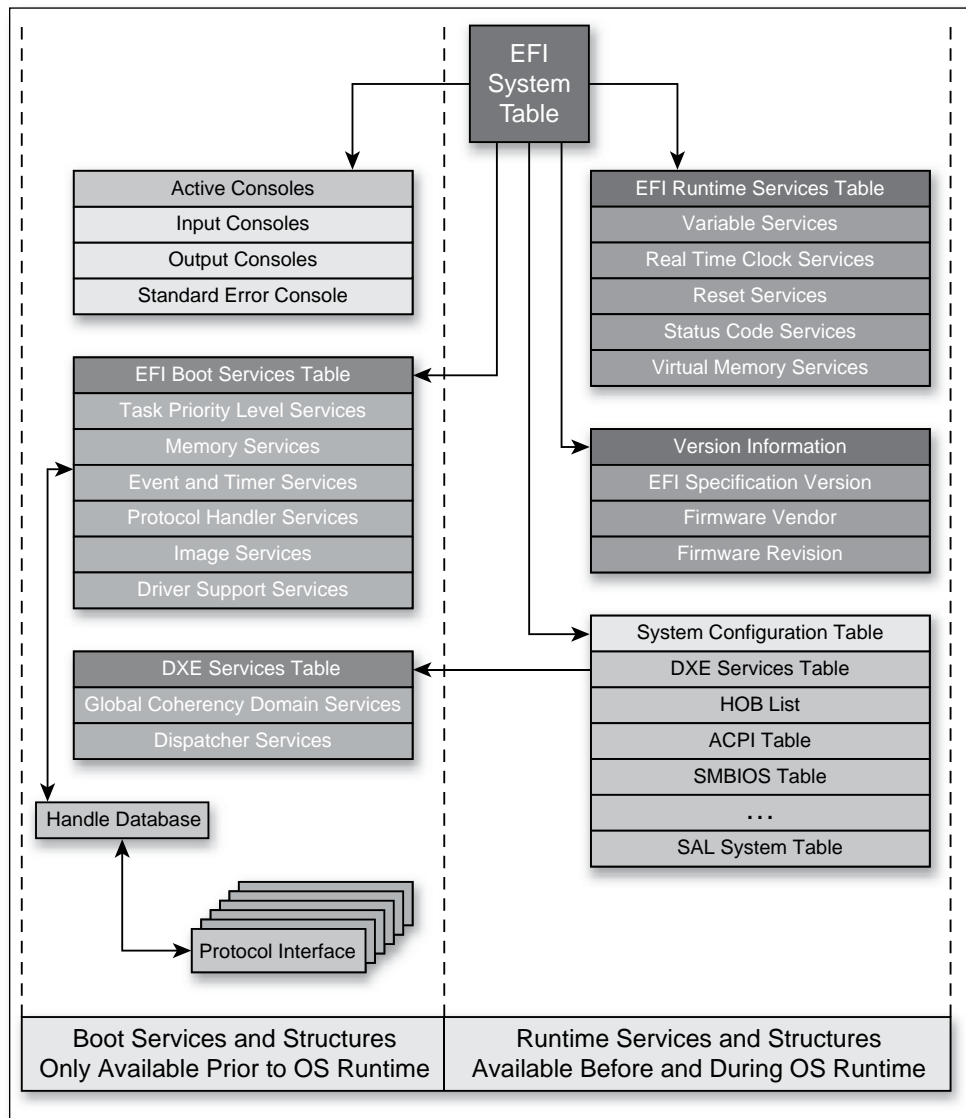

Figure 8.5 EFI System Table and Related Components

The DXE Core produces the EFI Boot Services, EFI Runtime Services, and DXE Services with the aid of the DXE Architectural Protocols. The EFI System Table provides access to all the active console devices in the platform and the set of EFI Configuration Tables. The EFI Configuration Tables are

an extensible list of tables that describe the configuration of the platform including pointers to tables such as DXE Services, the HOB list, ACPI, System Management BIOS (SMBIOS), and the SAL System Table. This list may be expanded in the future as new table types are defined. Also, through the use of the Protocol Handle Services in the EFI Boot Services Table, any executable image can access the handle database and any of the protocol interfaces that have been registered by DXE drivers.

When the transition to the OS runtime is performed, the handle database, active consoles, EFI Boot Services, and services provided by boot service DXE drivers are terminated. This termination frees more memory for use by the OS and leaves the EFI System Table, EFI Runtime Services Table, and the system configuration tables available in the OS runtime environment. You also have the option of converting all of the EFI Runtime Services from a physical address space to an operating system specific virtual address space. This address space conversion may only be performed once.

EFI Boot Services Table

The following is a brief summary of the services that are available through the EFI Boot Services Table:

- **Task Priority Services:** Provides services to increase or decrease the current task priority level. This priority mechanism can be used to implement simple locks and to disable the timer interrupt for short periods of time. These services depend on the CPU Architectural Protocol.
- **Memory Services:** Provides services to allocate and free pages in 4 KB increments and allocate and free pool on byte boundaries. It also provides a service to retrieve a map of all the current physical memory usage in the platform.
- **Event and Timer Services:** Provides services to create events, signal events, check the status of events, wait for events, and close events. One class of events is timer events, which supports periodic timers with variable frequencies and one-shot timers with variable durations. These services depend on the CPU Architectural Protocol, Timer Architectural Protocol, Metronome Architectural Protocol, and Watchdog Timer Architectural Protocol.

- **Protocol Handler Services:** Provides services to add and remove handles from the handle database. It also provides services to add and remove protocols from the handles in the handle database. Additional services are available that allow any component to look up handles in the handle database and open and close protocols in the handle database.
- **Image Services:** Provides services to load, start, exit, and unload images using the PE/COFF image format. These services depend on the Security Architectural Protocol.
- **Driver Support Services:** Provides services to connect and disconnect drivers to devices in the platform. These services are used by the BDS phase to either connect all drivers to all devices, or to connect only the minimum number of drivers to devices required to establish the consoles and boot an OS. The minimal connect strategy is how a fast boot mechanism is provided.

EFI Runtime Services Table

The following is a brief summary of the services that are available through the EFI Runtime Services Table:

- **Variable Services:** Provides services to lookup, add, and remove environment variables from nonvolatile storage. These services depend on the Variable Architectural Protocol and the Variable Write Architectural Protocol.
- **Real Time Clock Services:** Provides services to get and set the current time and date. It also provides services to get and set the time and date of an optional wakeup timer. These services depend on the Real Time Clock Architectural Protocol.
- **Reset Services:** Provides services to shutdown or reset the platform. These services depend on the Reset Architectural Protocol.

- **Status Code Services:** Provides services to send status codes to a system log or a status code reporting device. These services depend on the Status Code Architectural Protocol.
- **Virtual Memory Services:** Provides services that allow the runtime DXE components to be converted from a physical memory map to a virtual memory map. These services can only be called once in physical mode. Once the physical to virtual conversion has been performed, these services cannot be called again. These services depend on the Runtime Architectural Protocol.

DXE Services Table

The following is a brief summary of the services that are available through the DXE Services Table:

- **Global Coherency Domain Services:** Provides services to manage I/O resources, memory-mapped I/O resources, and system memory resources in the platform. These services are used to dynamically add and remove these resources from the processor's Global Coherency Domain (GCD).
- **DXE Dispatcher Services:** Provides services to manage DXE drivers that are being dispatched by the DXE Dispatcher.

Global Coherency Domain Services

The Global Coherency Domain (GCD) Services are used to manage the memory and I/O resources visible to the boot processor. These resources are managed in two different maps:

- GCD memory space map
- GCD I/O space map

If memory or I/O resources are added, removed, allocated, or freed, then the GCD memory space map and GCD I/O space map are updated. GCD Services are also provided to retrieve the contents of these two resource maps.

The GCD Services can be broken up into two groups. The first manages the memory resources visible to the boot processor, and the second manages the I/O resources visible to the boot processor. Not all processor types support I/O resources, so the management of I/O resources may not be required. However, since system memory resources and memory-mapped I/O resources are required to execute the DXE environment, the management of memory resources is always required.

GCD Memory Resources

The Global Coherency Domain (GCD) Services used to manage memory resources include the following:

- `AddMemorySpace()`
- `AllocateMemorySpace()`
- `FreeMemorySpace()`
- `RemoveMemorySpace()`
- `SetMemorySpaceAttributes()`

The GCD Services used to retrieve the GCD memory space map include the following:

- `GetMemorySpaceDescriptor()`
- `GetMemorySpaceMap()`

The GCD memory space map is initialized from the HOB list that is passed to the entry point of the DXE Core. One HOB type describes the number of address lines that are used to access memory resources. This information is used to initialize the state of the GCD memory space map. Any memory regions outside this initial region are unavailable to any of the GCD Services that are used to manage memory resources. The GCD memory space map is designed to describe the memory address space with as many as 64 address lines. Each region in the GCD memory space map can begin and end on a byte boundary. Additional HOB types describe the location of system memory, the location memory mapped I/O, the location of firmware devices, the location

of firmware volumes, the location of reserved regions, and the location of system memory regions that were allocated prior to the execution of the DXE Core. The DXE Core must parse the contents of the HOB list to guarantee that memory regions reserved prior to the execution of the DXE Core are honored. As a result, the GCD memory space map must reflect the memory regions described in the HOB list. The GCD memory space map provides the DXE Core with the information required to initialize the memory services such as `AllocatePages()`, `FreePages()`, `AllocatePool()`, `FreePool()`, and `GetMemoryMap()`.

A memory region described by the GCD memory space map can be in one of several different states:

- Nonexistent memory
- System memory
- Memory-mapped I/O
- Reserved memory

These memory regions can be allocated and freed by DXE drivers executing in the DXE environment. In addition, a DXE driver can attempt to adjust the caching attributes of a memory region. Figure 8.6 shows the possible state transitions for each byte of memory in the GCD memory space map. The transitions are labeled with the GCD Service that can move the byte from one state to another. The GCD services are required to merge similar memory regions that are adjacent to each other into a single memory descriptor, which reduces the number of entries in the GCD memory space map.

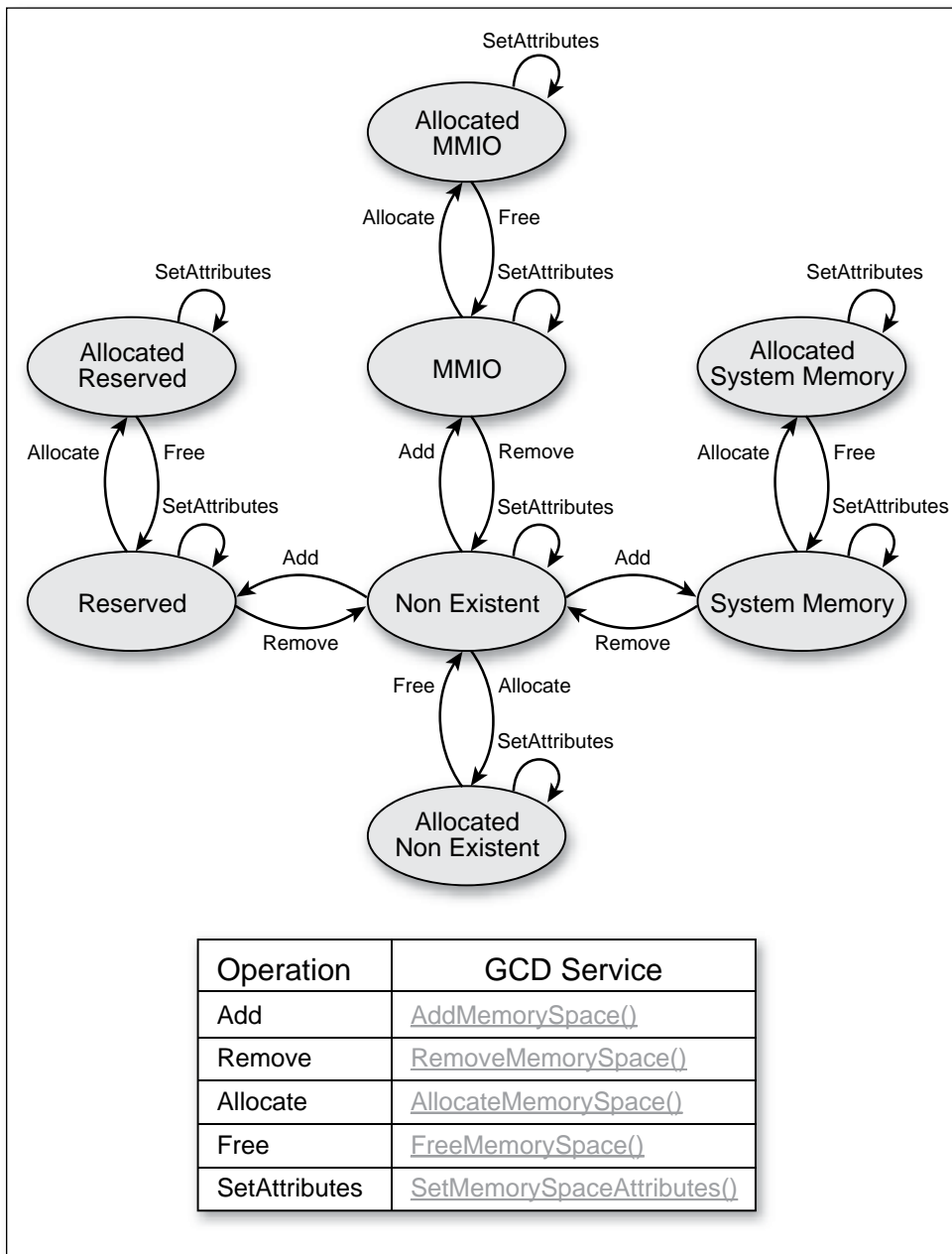

Figure 8.6 GCD Memory State Transitions

GCD I/O Resources

The Global Coherency Domain (GCD) Services used to manage I/O resources include the following:

- `AddIoSpace()`
- `AllocateIoSpace()`
- `FreeIoSpace()`
- `RemoveIoSpace()`

The GCD Services used to retrieve the GCD I/O space map include the following:

- `GetIoSpaceDescriptor()`
- `GetIoSpaceMap()`

The GCD I/O space map is initialized from the HOB list that is passed to the entry point of the DXE Core. One HOB type describes the number of address lines that are used to access I/O resources. This information is used to initialize the state of the GCD I/O space map. Any I/O regions outside this initial region are not available to any of the GCD Services that are used to manage I/O resources. The GCD I/O space map is designed to describe the I/O address space with as many as 64 address lines. Each region in the GCD I/O space map can begin and end on a byte boundary.

An I/O region described by the GCD I/O space map can be in several different states. These include nonexistent I/O, I/O, and reserved I/O. These I/O regions can be allocated and freed by DXE drivers executing in the DXE environment. Figure 8.7 shows the possible state transitions for each byte of I/O in the GCD I/O space map. The transitions are labeled with the GCD Service that can move the byte from one state to another. The GCD Services are required to merge similar I/O regions that are adjacent to each other into a single I/O descriptor, which reduces the number of entries in the GCD I/O space map.

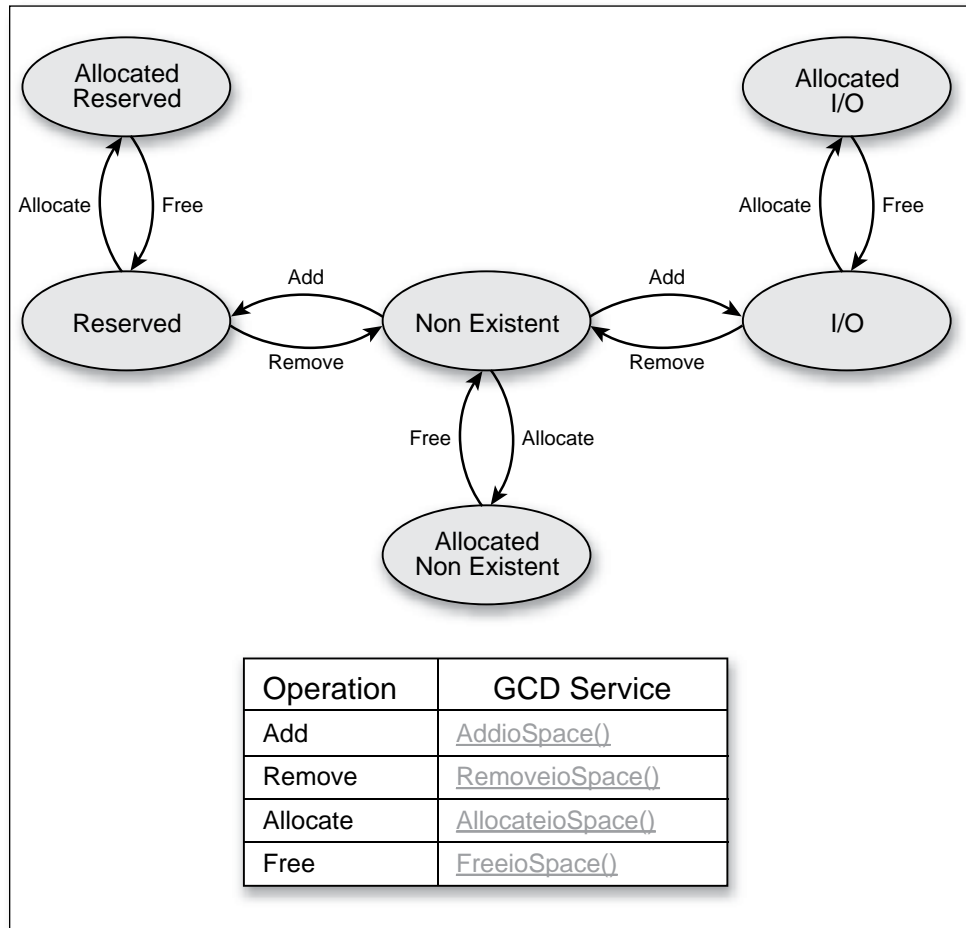

Figure 8.7 GCD I/O State Transitions

DXE Dispatcher

After the DXE Core is initialized, control is handed to the DXE Dispatcher. The DXE Dispatcher is responsible for loading and invoking DXE drivers found in firmware volumes. The DXE Dispatcher searches for drivers in the firmware volumes described by the HOB list. As execution continues, other firmware volumes might be located. When they are, the DXE Dispatcher searches them for drivers as well.

When a new firmware volume is discovered, a search is made for its a priori file. The a priori file has a fixed file name and contains the list of DXE drivers that should be loaded and executed first. There can be at most one a priori file per firmware volume, although it is acceptable to have no a priori file at all. Once the DXE drivers from the a priori file have been loaded and executed, the dependency expressions of the remaining DXE drivers in the firmware volumes are evaluated to determine the order in which they will be loaded and executed. The a priori file provides a strongly ordered list of DXE drivers that are not required to use dependency expressions. The dependency expressions provide a weakly ordered execution of the remaining DXE drivers. Before each DXE driver is executed, it must be authenticated with the Security Architectural Protocol. This authentication prevents DXE drivers with unknown origins from being executed.

Control is transferred from the DXE Dispatcher to the BDS Architectural Protocol after the DXE drivers in the a priori file and all the DXE drivers whose dependency expressions evaluate to TRUE have been loaded and executed. The BDS Architectural Protocol is responsible for establishing the console devices and attempting the boot of operating systems. As the console devices are established and access to boot devices is established, additional firmware volumes may be discovered. If the BDS Architectural Protocol is unable to start a console device or gain access to a boot device, it reinvokes the DXE Dispatcher. This invocation allows the DXE Dispatcher to load and execute DXE drivers from firmware volumes that have been discovered since the last time the DXE Dispatcher was invoked. Once the DXE Dispatcher has loaded and executed all the DXE drivers it can, control is once again returned to the BDS Architectural Protocol to continue the OS boot process. Figure 8.8 illustrates this basic flow between the Dispatcher, its launched drivers, and the BDS.

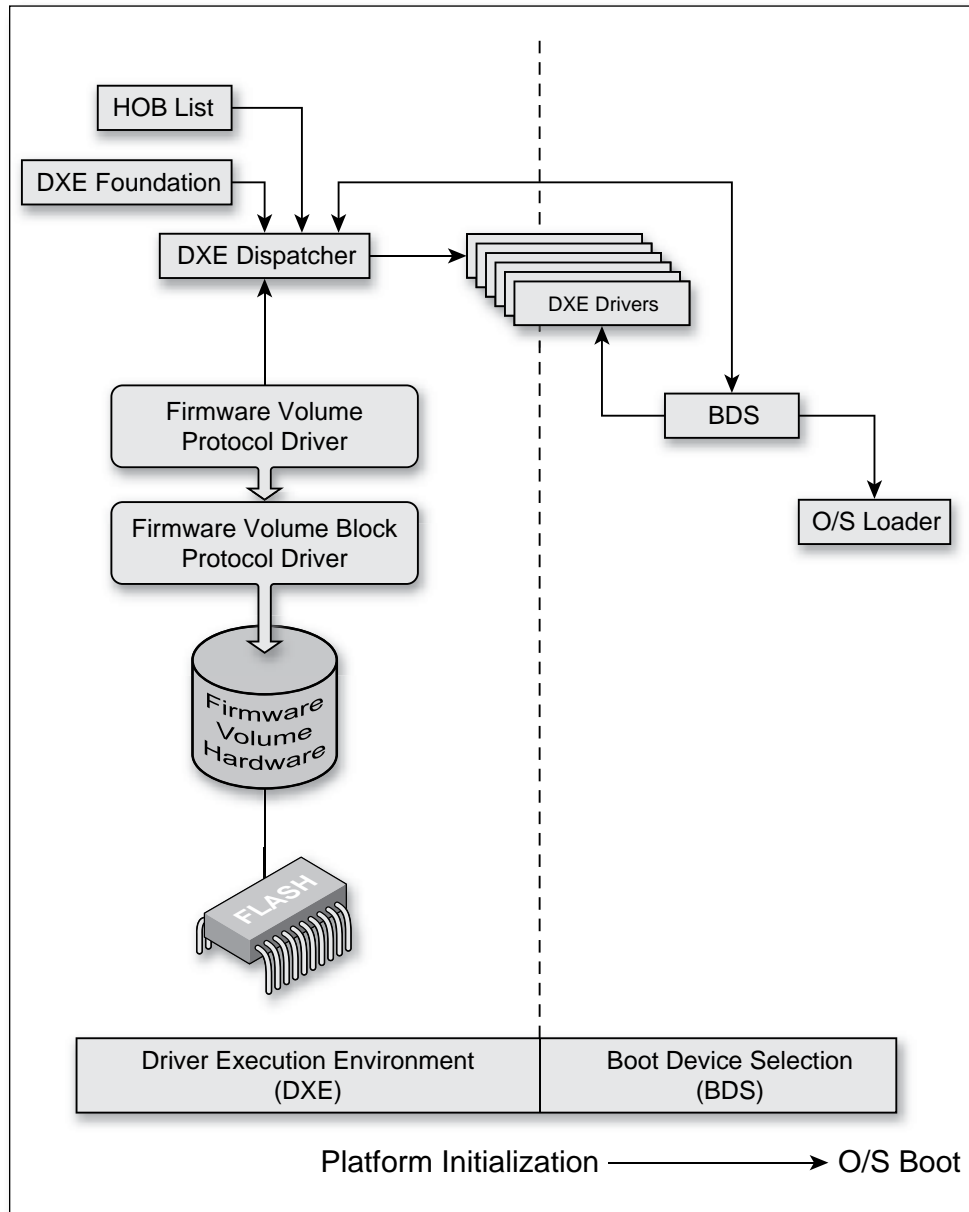

Figure 8.8 The Handshake between the Dispatcher and Other Components.

The *a priori* File

The *a priori* file is a special file that may be present in a firmware volume. The rule is that there may be at most one *a priori* file per firmware volume present in a platform. The *a priori* file has a known GUID file name, so the DXE Dispatcher can always find the *a priori* file. Every time the DXE Dispatcher discovers a firmware volume, it first looks for the *a priori* file. The *a priori* file contains the list of DXE drivers that should be loaded and executed before any other DXE drivers are discovered. The DXE drivers listed in the *a priori* file are executed in the order that they appear. If any of those DXE drivers have an associated dependency expression, then those dependency expressions are ignored.

The purpose of the *a priori* file is to provide a deterministic execution order of DXE drivers. DXE drivers that are executed solely based on their dependency expression are weakly ordered, which means that the execution order is not completely deterministic between boots or between platforms. Some cases, however, require a deterministic execution order. One example would be to list the DXE drivers that are required to debug the rest of the DXE phase in the *a priori* file. These DXE drivers that provide debug services might have been loaded much later if only their dependency expressions were considered. By loading them earlier, more of the DXE Core and DXE drivers can be debugged. Another example is to use the *a priori* file to eliminate the need for dependency expressions. Some embedded platforms may require only a few DXE drivers with a highly deterministic execution order. The *a priori* file can provide this ordering, and none of the DXE drivers would require dependency expressions. The dependency expressions do have some amount of firmware device overhead, so this method might actually conserve firmware space. The main purpose of the *a priori* file is to provide a greater degree of flexibility in the firmware design of a platform.

Dependency Grammar

A DXE driver is stored in a firmware volume as a file with one or more sections. One of the sections must be a PE/COFF image. If a DXE driver has a dependency expression, then it is stored in a dependency section. A DXE driver may contain additional sections for compression and security wrappers. The DXE Dispatcher can identify the DXE drivers by their file type. In addition, the DXE Dispatcher can look up the dependency expression for a DXE driver

by looking for a dependency section in a DXE driver file. The dependency section contains a section header followed by the actual dependency expression that is composed of a packed byte stream of opcodes and operands.

Dependency expressions stored in dependency sections are designed to be small to conserve space. In addition, they are designed to be simple and quick to evaluate to reduce execution overhead. These two goals are met by designing a small, stack-based instruction set to encode the dependency expressions. The DXE Dispatcher must implement an interpreter for this instruction set to evaluate dependency expressions. Table 8.1 gives a summary of the supported opcodes in the dependency expression instruction set.

Table 8.1 Supported Opcodes in the Dependency Expression Instruction Set

Opcod	Description
0x00	BEFORE <File Name GUID>
0x01	AFTER <File Name GUID>
0x02	PUSH <Protocol GUID>
0x03	AND
0x04	OR
0x05	NOT
0x06	TRUE
0x07	FALSE
0x08	END
0x09	SOR

Because multiple dependency expressions may evaluate to TRUE at the same time, the order in which the DXE drivers are loaded and executed may vary between boots and between platforms even though the contents of their firmware volumes are identical. This variation is why the ordering is weak for the execution of DXE drivers in a platform when dependency expressions are used.

DXE Drivers

DXE drivers have two subclasses:

- DXE drivers that execute very early in the DXE phase
- DXE drivers that comply with the UEFI Driver Model

The execution order of the first subclass, the early DXE drivers, depends on the presence and contents of an a priori file and the evaluation of dependency expressions. These early DXE drivers typically contain processor, chipset, and platform initialization code. They also typically produce the DXE Architectural Protocols that are required for the DXE Core to produce its full complement of EFI Boot Services and EFI Runtime Services. To support the fastest possible boot time, as much initialization as possible should be deferred to the second subclass of DXE drivers, those that comply with the UEFI Driver Model.

The DXE drivers that comply with the UEFI Driver Model do not perform any hardware initialization when they are executed by the DXE Dispatcher. Instead, they register a Driver Binding Protocol interface in the handle database. The set of Driver Binding Protocols are used by the BDS phase to connect the drivers to the devices required to establish consoles and provide access to boot devices. The DXE Drivers that comply with the UEFI Driver Model ultimately provide software abstractions for console devices and boot devices but only when they are explicitly asked to do so.

All DXE drivers may consume the EFI Boot Services and EFI Runtime Services to perform their functions. However, the early DXE drivers need to be aware that not all of these services may be available when they execute because not all of the DXE Architectural Protocols might have been registered yet. DXE drivers must use dependency expressions to guarantee that the services and protocol interfaces they require are available before they are executed.

The DXE drivers that comply with the UEFI Driver Model do not need to be concerned with this possibility. These drivers simply register the Driver Binding Protocol in the handle database when they are executed. This operation can be performed without the use of any DXE Architectural Protocols. The BDS phase will not be entered until all of the DXE Architectural Protocols are registered. If the DXE Dispatcher does not have any more DXE drivers to execute but not all of the DXE Architectural Protocols have been registered, then a fatal error has occurred and the system will be halted.

Boot Device Selection (BDS) Phase

The Boot Device Selection (BDS) Architectural Protocol executes during the BDS phase. The BDS Architectural Protocol is discovered in the DXE phase, and it is executed when two conditions are met:

- All of the DXE Architectural Protocols have been registered in the handle database. This condition is required for the DXE Core to produce the full complement of EFI Boot Services and EFI Runtime Services.
- The DXE Dispatcher does not have any more DXE drivers to load and execute. This condition occurs only when all the a priori files from all the firmware volumes have been processed and all the DXE drivers whose dependency expression have evaluated to TRUE have been loaded and executed.

The BDS Architectural Protocol locates and loads various applications that execute in the pre-boot services environment. Such applications might represent a traditional OS boot loader or extended services that might run instead of or prior to loading the final OS. Such extended pre-boot services might include setup configuration, extended diagnostics, flash update support, OEM services, or the OS boot code.

Vendors such as IBVs, OEMs, and ISVs may choose to use a reference implementation, develop their own implementation based on the reference, or develop an implementation from scratch.

The BDS phase performs a well-defined set of tasks. The user interface and user interaction that occurs on different boots and different platforms may vary, but the boot policy that the BDS phase follows is very rigid. This boot policy is required so OS installations will behave predictably from platform to platform. The tasks include the following:

- Initialize console devices based on the `ConIn`, `ConOut`, and `StdErr` environment variables.
- Attempt to load all drivers listed in the `Driver####` and `DriverOrder` environment variables.

- Attempt to boot from the boot selections listed in the `Boot####` and `BootOrder` environment variables.

If the BDS phase is unable to connect a console device, load a driver, or boot a boot selection, it is required to reinvoke the DXE Dispatcher. This invocation is required because additional firmware volumes may have been discovered while attempting to perform these operations. These additional firmware volumes may contain the DXE drivers required to manage the console devices or boot devices. Once all of the DXE drivers have been dispatched from any newly discovered firmware volumes, control is returned to the BDS phase. If the BDS phase is unable to make any additional forward progress in connecting the console device or the boot device, then the connection of that console device or boot selection fails. When a failure occurs, the BDS phase moves on to the next console device, driver load, or boot selection.

Console Devices

Console devices are abstracted through the Simple Text Output and Simple Input Protocols. Any device that produces one or both of these protocols may be used as a console device on a UEFI-based platform. Several types of devices are capable of producing these protocols, including the following:

- **VGA Adapters:** These adapters can produce a text-based display that is abstracted with the Simple Text Output Protocol.
- **Video Adapters:** These adapters can produce a Graphics Output Protocol (GOP) which is a graphical interface that supports Block Transfer (BLT) operations. A text-based display that produces the Simple Text Output Protocol can be simulated on top of a GOP display by using BLT operations to send Unicode glyphs into the frame buffer. GOP is also the means by which graphics is typically rendered to the local video device.
- **Serial Terminal:** A serial terminal device can produce both the Simple Input and Simple Text Output Protocols. Serial terminals are very flexible, and they can support a variety of wire protocols such as PC ANSI, VT-100, VT-100+, and VTUTF8.

- Telnet: A telnet session can produce both the Simple Input and Simple Text Output Protocols. Like the serial terminal, a variety of wire protocols can be supported including PC ANSI, VT-100, VT-100+, and VTUTF8.
- Remote Graphical Displays (HTTP): A remote graphical display can produce both the Simple Input and Simple Text Output Protocols. One possible implementation could use HTTP, so standard Internet browsers could be used to manage a UEFI-based platform.

Boot Devices

Several types of boot devices are supported in UEFI:

- Devices that produce the Block I/O Protocol and are formatted with a FAT file system
- Devices that directly produce the File System Protocol
- Devices that directly produce the Load File Protocol

Disk devices typically produce the Block I/O Protocol, and network devices typically produce the Load File Protocol.

A UEFI implementation may also choose to include legacy compatibility drivers. These drivers provide the services required to boot a traditional OS, and the BDS phase could then also support booting a traditional OS.

Boot Services Terminate

The BDS phase is terminated when an OS loader is executed and an OS is successfully booted. An OS loader or an OS kernel may call a single service called `ExitBootServices()` to terminate the BDS phase. Once this call is made, all of the boot service components are freed and their resources are available for use by the OS. When the call to `ExitBootServices()` returns, the Runtime (RT) phase has been entered.

Summary

In conclusion, the DXE phase encompasses the establishing of the entire infrastructure necessary for UEFI compliant components to operate. This includes the establishment of the service tables and other requisite architectural protocols. As the DXE phase completes and passes control to the BDS, the platform then proceeds to complete any initialization required to launch of boot target.

Some Common UEFI and PI Functions

Never let the future disturb you. You will meet it, if you have to, with the same weapons of reason which today arm you against the present.

—Marcus Aurelius Antoninus

UEFI provides a variety of functions that are used for drivers and applications to communicate with the underlying UEFI components. Many of the designs for interfaces have historically been short-sighted due to their inability to predict changes in technology. An example of such shortsightedness might be where a disk interface assumed that a disk might never have more than 8 gigabytes of space available. It is often hard to predict what changes technology might provide. Many famous statements have been made that fret about how a personal computer might never be practical, or assure readers that 640 kilobytes of memory would be more than anyone would ever need. With these poor past predictions in mind, one can attempt to learn from such mistakes and design interfaces that are robust enough for common practices today, and make the best attempt at predicting how one might use these interfaces years from today.

This chapter describes a selection of common interfaces that show up in UEFI as well as the PI specifications:

- *Architectural Protocols:* These are a set of protocols that abstract the platform hardware from the UEFI drivers and applications. They are unusual only in that they are the protocols that are going to be used

by the UEFI compatible firmware implementation. These protocols in their current form were introduced into the PI specifications.

- *PCI Protocols*: These protocols abstract all aspects of interaction with the underlying PCI bus, enumeration of said bus, as well as resource allocation. These interfaces were introduced for UEFI, and would be present in both UEFI and PI implementations.
- *Block I/O*: This protocol is used to abstract mass storage devices to allow code running in the EFI Boot Services environment to access them without specific knowledge of the type of device or controller that manages the device. This interface was introduced for UEFI, and would be present in both UEFI and PI implementations.
- *Disk I/O*: This protocol is used to abstract the block accesses of the Block I/O protocol to a more general offset-length protocol. The firmware is responsible for adding this protocol to any Block I/O interface that appears in the system that does not already have a Disk I/O protocol. File systems and other disk access code utilize the Disk I/O protocol. This interface was introduced for UEFI, and would be present in both UEFI and PI implementations.
- *Simple File System*: This protocol allows code running in the EFI Boot Services environment to obtain file-based access to a device. The Simple File System protocol is used to open a device volume and return an `EFI_FILE` handle that provides interfaces to access files on a device volume. This interface was introduced for UEFI, and would be present in both UEFI and PI implementations.

Architectural Protocol Examples

A variety of architectural protocols exist in the platform. These protocols function just like other protocols in every way. The only difference is that these protocols are consumed by the platform's core services and the remainder of the drivers and applications in turn call these core services to act on the platform in various ways. Generally, the only users of the architectural protocols are the core services themselves. The architectural protocols abstract the hardware

and are the only agents in the system that would typically talk directly to the hardware in the pre-boot environment. Everything else in the system would communicate with a core service to communicate any sort of requests to the hardware. Figure 9.1 illustrates this high level software handshake.

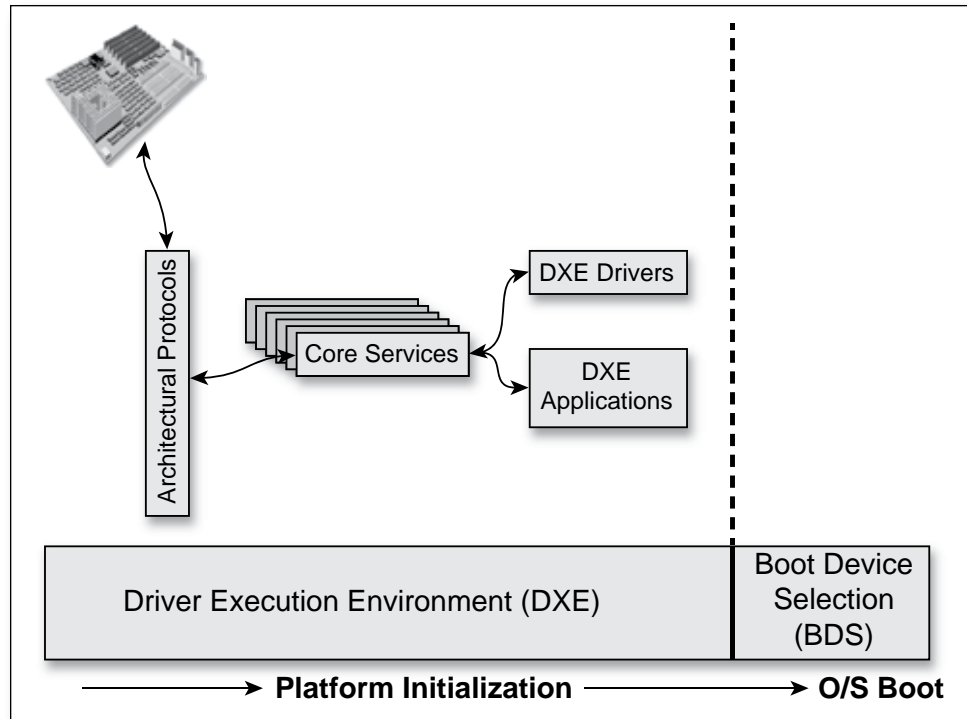

Figure 9.1 Platform Software Flow Diagram

To show more clearly how some of these architectural protocols are designed and how they operate, several key examples will be examined in further detail. Note that the following examples are not the full set of architectural protocols but are used to illustrate some of their functionality. For the full set, please refer to the appropriate DXE specifications.

CPU Architectural Protocol

The CPU Architectural Protocol is used to abstract processor-specific functions from the DXE Foundation. This includes flushing caches, enabling and disabling interrupts, hooking interrupt vectors and exception vectors, reading internal processor timers, resetting the processor, and determining the processor frequency. This protocol must be produced by a boot service or runtime DXE driver and may only be consumed by the DXE Foundation and DXE drivers that produce architectural protocols. By allowing this protocol to be produced by a boot service driver, it is evident that this abstraction will not persist when the platform has the boot services terminated by launching a boot target such as an operating system.

The GCD memory space map is initialized by the DXE Foundation based on the contents of the HOB list. The HOB list contains the capabilities of the different memory regions, but it does not contain their current attributes. The DXE driver that produces the CPU Architectural Protocol is responsible for maintaining the current attributes of the memory regions visible to the processor.

This means that the DXE driver that produces the CPU Architectural Protocol must seed the GCD memory space map with the initial state of the attributes for all the memory regions visible to the processor. The DXE Service `SetMemorySpaceAttributes()` allows the attributes of a memory range to be modified. The `SetMemorySpaceAttributes()` DXE Service is implemented using the `SetMemoryAttributes()` service of the CPU Architectural Protocol.

To initialize the state of the attributes in the GCD memory space map, the DXE driver that produces the CPU Architectural Protocol must call the DXE Service `SetMemorySpaceAttributes()` for all the different memory regions visible to the processor passing in the current attributes. This, in turn, will call back to the `SetMemoryAttributes()` service of the CPU Architectural Protocol, and all of these calls must return `EFI_SUCCESS`, since the DXE Foundation is only requesting that the attributes of the memory region be set to their current settings. This forces the current attributes in the GCD memory space map to be set to these current settings. After this initialization is complete, the next call to the DXE Service `GetMemorySpaceMap()` will correctly show the current attributes of all the memory regions. In addition, any future calls to the DXE Service `SetMemorySpaceAttributes()` will in turn call the CPU Architectural Protocol to see if those attributes can

be modified, and if they can, the GCD memory space map will be updated accordingly.

The CPU Architectural Protocol uses the following protocol definition:

```
Protocol Interface Structure
typedef struct _EFI_CPU_ARCH_PROTOCOL {
    EFI_CPU_FLUSH_DATA_CACHE           FlushDataCache;
    EFI_CPU_ENABLE_INTERRUPT           EnableInterrupt;
    EFI_CPU_DISABLE_INTERRUPT          DisableInterrupt;
    EFI_CPU_GET_INTERRUPT_STATE         GetInterruptState;
    EFI_CPU_INIT                        Init;
    EFI_CPU_REGISTER_INTERRUPT_HANDLER  RegisterInterruptHandler;
    EFI_CPU_GET_TIMER_VALUE             GetTimerValue;
    EFI_CPU_SET_MEMORY_ATTRIBUTES       SetMemoryAttributes;
    UINT32                               NumberOfTimers;
    UINT32                               DmaBufferAlignment;
} EFI_CPU_ARCH_PROTOCOL;
```

- *FlushDataCache* – Flushes a range of the processor’s data cache. If the processor does not contain a data cache, or the data cache is fully coherent, then this function can just return `EFI_SUCCESS`. If the processor does not support flushing a range of addresses from the data cache, then the entire data cache must be flushed. This function is used by the root bridge I/O abstractions to flush data caches for DMA operations.
- *EnableInterrupt* – Enables interrupt processing by the processor. See the `EnableInterrupt()` function description. This function is used by the Boot Service `RaiseTPL()` and `RestoreTPL()`.
- *DisableInterrupt* – Disables interrupt processing by the processor. See the `DisableInterrupt()` function description. This function is used by the Boot Service `RaiseTPL()` and `RestoreTPL()`.
- *GetInterruptState* – Retrieves the processor’s current interrupt state.
- *Init* – Generates an INIT on the processor. This function may be used by the Reset Architectural Protocol depending upon a specified boot path. If a processor cannot programmatically generate an INIT without help from external hardware, then this function returns `EFI_UNSUPPORTED`.

- *RegisterInterruptHandler* – Associates an interrupt service routine with one of the processor’s interrupt vectors. This function is typically used by the `EFI_TIMER_ARCH_PROTOCOL` to hook the timer interrupt in a system. It can also be used by the debugger to hook exception vectors.
- *GetTimerValue* – Returns the value of one of the processor’s internal timers.
- *SetMemoryAttributes* – Attempts to set the attributes of a memory region.
- *NumberOfTimers* – Gives the number of timers that are available in a processor. The value in this field is a constant that must not be modified after the CPU Architectural Protocol is installed. All consumers must treat this as a read-only field.
- *DmaBufferAlignment* – Gives the size, in bytes, of the alignment required for DMA buffer allocations. This is typically the size of the largest data cache line in the platform. This value can be determined by looking at the data cache line sizes of all the caches present in the platform, and returning the largest. This is used by the root bridge I/O abstraction protocols to guarantee that no two DMA buffers ever share the same cache line. The value in this field is a constant that must not be modified after the CPU Architectural Protocol is installed. All consumers must treat this as a read-only field.

Real Time Clock Architectural Protocol

The Real Time Clock Architectural Protocol provides the services required to access a system’s real time clock hardware. This protocol must be produced by a runtime DXE driver and may only be consumed by the DXE Foundation.

The DXE driver that produces this protocol must be a runtime driver. This driver is responsible for initializing the `GetTime()`, `SetTime()`, `GetWakeupTime()`, and `SetWakeupTime()` fields of the EFI Runtime Services Table. See the section “Time Services” in Chapter 5 for details on these services. After the four fields of the EFI Runtime Services Table have been initialized, the driver must install the Real Time Clock Architectural

Protocol on a new handle with a NULL interface pointer. The installation of this protocol informs the DXE Foundation that the real time clock-related services are now available and that the DXE Foundation must update the 32-bit CRC of the EFI Runtime Services Table.

Timer Architectural Protocol

The Timer Architectural Protocol provides the services to initialize a periodic timer interrupt and to register a handler that is called each time the timer interrupt fires. It may also provide a service to adjust the rate of the periodic timer interrupt. When a timer interrupt occurs, the handler is passed the amount of time that has passed since the previous timer interrupt. This protocol enables the use of the `SetTimer()` Boot Service. This protocol must be produced by a boot service or runtime DXE driver and may only be consumed by the DXE Foundation or DXE drivers that produce other DXE Architectural Protocols. By allowing this protocol to be produced by a boot service driver, it is evident that this abstraction will not persist when the platform has the boot services terminated by launching a boot target, such as an operating system.

Protocol Interface Structure

```
typedef struct _EFI_TIMER_ARCH_PROTOCOL {
    EFI_TIMER_REGISTER_HANDLER      RegisterHandler;
    EFI_TIMER_SET_TIMER_PERIOD      SetTimerPeriod;
    EFI_TIMER_GET_TIMER_PERIOD      GetTimerPeriod;
    EFI_TIMER_GENERATE_SOFT_INTERRUPT GenerateSoftInterrupt;
} EFI_TIMER_ARCH_PROTOCOL;
```

- *RegisterHandler* – Registers a handler that is called each time the timer interrupt fires. *TimerPeriod* defines the minimum time between timer interrupts, so *TimerPeriod* is also the minimum time between calls to the registered handler.
- *SetTimerPeriod* – Sets the period of the timer interrupt in 100 nanosecond units. This function is optional and may return `EFI_UNSUPPORTED`. If this function is supported, then the timer period is rounded up to the nearest supported timer period.
- *GetTimerPeriod* – Retrieves the period of the timer interrupt in 100 nanosecond units.

- *GenerateSoftInterrupt* – Generates a soft timer interrupt that simulates the firing of the timer interrupt. This service can be used to invoke the registered handler if the timer interrupt has been masked for a period of time.

Reset Architectural Protocol

The Reset Architectural Protocol provides the service required to reset a platform. This protocol must be produced by a runtime DXE driver and may only be consumed by the DXE Foundation. This driver is responsible for initializing the `ResetSystem()` field of the EFI Runtime Services Table. After this field of the EFI Runtime Services Table has been initialized, the driver must install the Reset Architectural Protocol on a new handle with a NULL interface pointer. The installation of this protocol informs the DXE Foundation that the reset system service is now available and that the DXE Foundation must update the 32-bit CRC of the EFI Runtime Services Table.

Boot Device Selection Architectural Protocol

The Boot Device Selection (BDS) Architectural Protocol transfers control from DXE to an operating system or a system utility, as illustrated in Figure 9.2. This protocol must be produced by a boot service or runtime DXE driver and may only be consumed by the DXE Foundation. By allowing this protocol to be produced by a boot service driver, it is evident that this abstraction will not persist when the platform has the boot services terminated by launching a boot target such as an operating system.

If not enough drivers have been initialized when this protocol is used to access the required boot device(s), then this protocol should add drivers to the dispatch queue and return control back to the dispatcher. Once the required boot devices are available, then the boot device can be used to load and invoke an OS or a system utility.

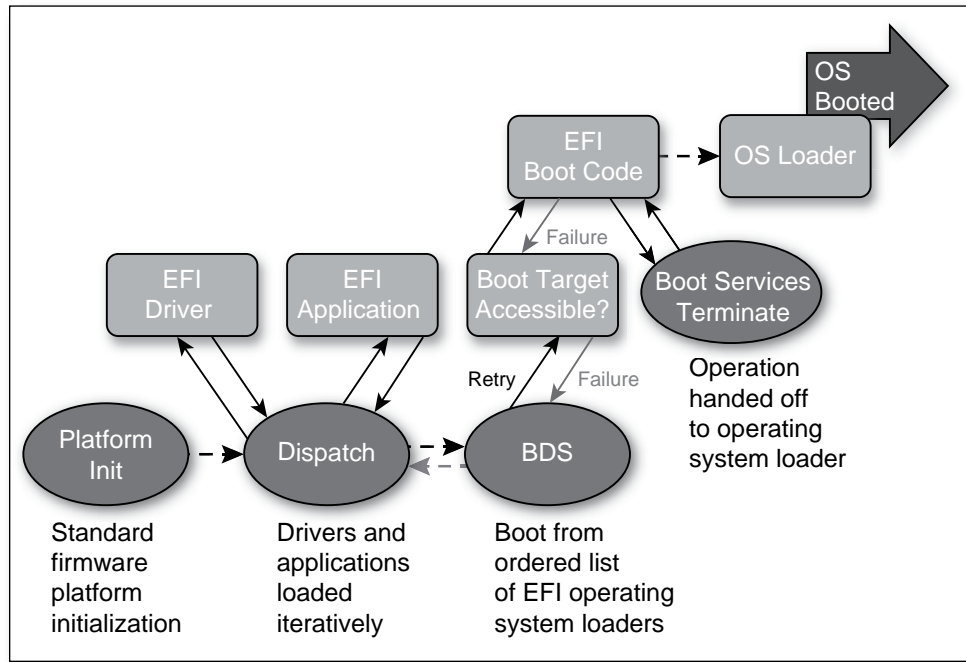

Figure 9.2 Basic Dispatch and BDS Software Flow

```

Protocol Interface Structure
typedef struct _EFI_BDS_ARCH_PROTOCOL {
    EFI_BDS_ENTRY    Entry;
} EFI_BDS_ARCH_PROTOCOL;

```

- *Entry* – The entry point to BDS. See the `Entry()` function description. This call does not take any parameters, and the return value can be ignored. If it returns, then the dispatcher must be invoked again, if it never returns, then an operating system or a system utility have been invoked.

Variable Architectural Protocol

The Variable Architectural Protocol provides the services required to get and set environment variables. This protocol must be produced by a runtime DXE driver and may be consumed only by the DXE Foundation. This driver is responsible for initializing the `GetVariable()`, `GetNextVariableName()`,

and `SetVariable()` fields of the EFI Runtime Services Table. See the section “Variable Services” in Chapter 5 for details on these services. After the three fields of the EFI Runtime Services Table have been initialized, the driver must install the Variable Architectural Protocol on a new handle with a NULL interface pointer. The installation of this protocol informs the DXE Foundation that the read-only and the volatile environment variable related services are now available and that the DXE Foundation must update the 32-bit CRC of the EFI Runtime Services Table. The full complement of environment variable services is not available until both this protocol and Variable Write Architectural Protocol are installed. DXE drivers that require read-only access or read/write access to volatile environment variables must have this architectural protocol in their dependency expressions. DXE drivers that require write access to nonvolatile environment variables must have the Variable Write Architectural Protocol in their dependency expressions.

Watchdog Timer Architectural Protocol

The Watchdog Timer Architectural Protocol is used to program the watchdog timer and optionally register a handler when the watchdog timer fires. This protocol must be produced by a boot service or runtime DXE driver and may be consumed only by the DXE Foundation or DXE drivers that produce other DXE Architectural Protocols. If a platform wishes to perform a platform-specific action when the watchdog timer expires, then the DXE driver containing the implementation of the BDS Architectural Protocol should use this protocol’s `RegisterHandler()` service.

This protocol provides the services required to implement the Boot Service `SetWatchdogTimer()`. It provides a service to set the amount of time to wait before firing the watchdog timer, and it also provides a service to register a handler that is invoked when the watchdog timer fires. This protocol can implement the watchdog timer by using the event and timer Boot Services, or it can make use of custom hardware. When the watchdog timer fires, control will be passed to a handler if a handler has been registered. If no handler has been registered, or the registered handler returns, then the system will be reset by calling the Runtime Service `ResetSystem()`.

Protocol Interface Structure

```
typedef struct _EFI_WATCHDOG_TIMER_ARCH_PROTOCOL {
    EFI_WATCHDOG_TIMER_REGISTER_HANDLER  RegisterHandler;
    EFI_WATCHDOG_TIMER_SET_TIMER_PERIOD  SetTimerPeriod;
    EFI_WATCHDOG_TIMER_GET_TIMER_PERIOD  GetTimerPeriod;
} EFI_WATCHDOG_TIMER_ARCH_PROTOCOL;
```

- *RegisterHandler* – Registers a handler that is invoked when the watchdog timer fires.
- *SetTimerPeriod* – Sets the amount of time in 100 nanosecond units to wait before the watchdog timer is fired. If this function is supported, then the watchdog timer period is rounded up to the nearest supported watchdog timer period.
- *GetTimerPeriod* – Retrieves the amount of time in 100 nanosecond units that the system will wait before the watchdog timer is fired.

PCI Protocols

This section describes a series of protocols that are all related to abstracting various aspects of PCI related interaction such as resource allocation and I/O.

PCI Host Bridge Resource Allocation Protocol

The PCI Host Bridge Resource Allocation Protocol is used by a PCI bus driver to program a PCI host bridge. The registers inside a PCI host bridge that control configuration of PCI root buses are not governed by the PCI specification and vary from chipset to chipset. The PCI Host Bridge Resource Allocation Protocol implementation is therefore specific to a particular chipset.

Each PCI host bridge is composed of one or more PCI root bridges, and hardware registers are associated with each PCI root bridge. These registers control the bus, I/O, and memory resources that are decoded by the PCI root bus that the PCI root bridge produces and all the PCI buses that are children of that PCI root bus.

The PCI Host Bridge Resource Allocate Protocol allows for future innovation of the chipsets. It abstracts the PCI bus driver from the chipset

details. This design allows system designers to make changes to the host bridge hardware without impacting a platform independent PCI bus driver.

Figure 9.3 shows a platform with a set of processors (CPUs) and a set of core chipset components that produce n host bridges. Most systems with one PCI host bus controller contain a single instance of the PCI Host Bridge Allocation Protocol. More complex systems may contain multiple instances of this protocol.

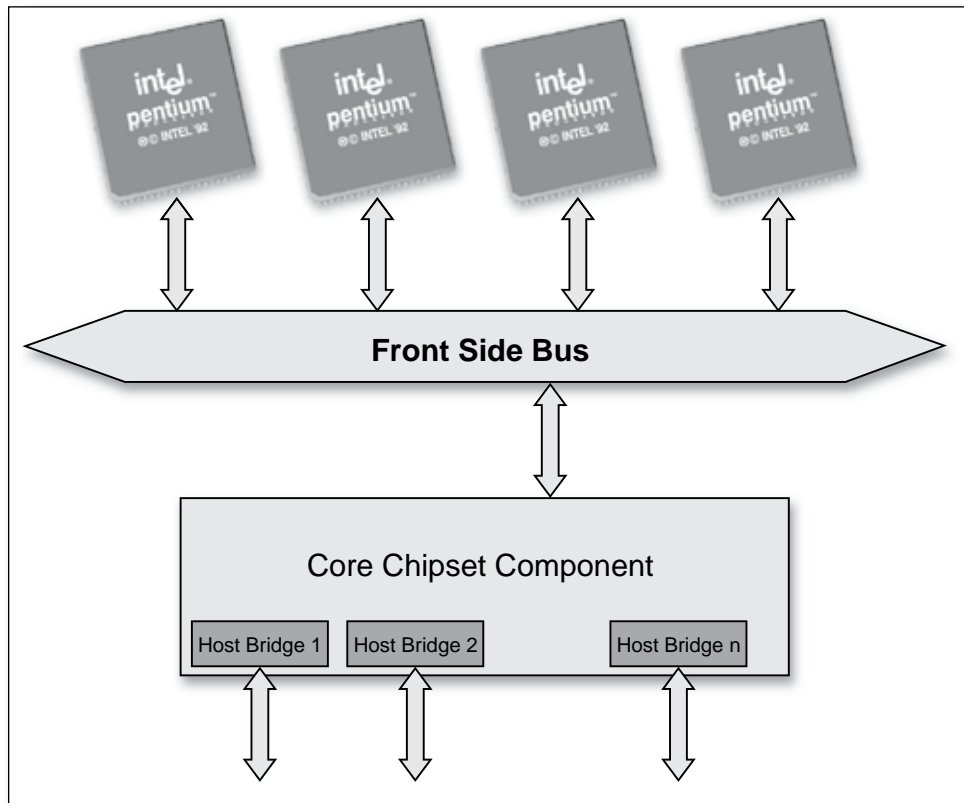

Figure 9.3 Example Host Bus Controllers

Figure 9.4 shows how the PCI Host Bridge Resource Allocation Protocol is used to identify the associated PCI root bridges. After the steps shown in Figure 9.4 are completed, the PCI Host Bridge Resource Allocation Protocol can then be queried to identify the device handles of the associated PCI root bridges.

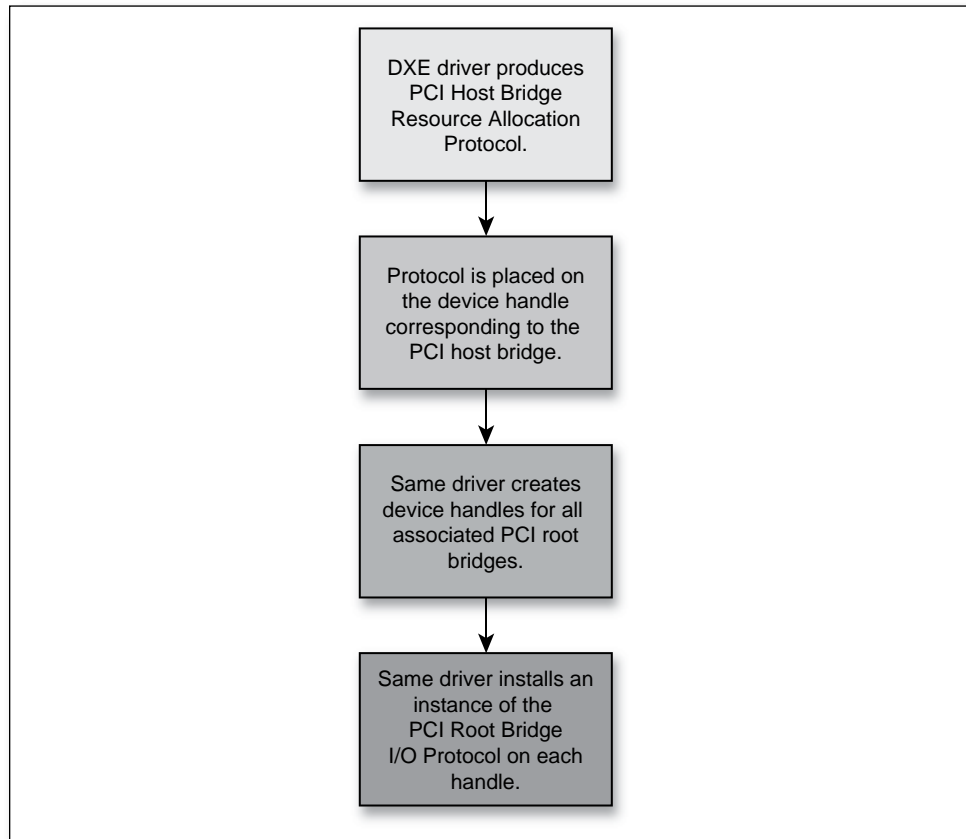

Figure 9.4 Producing the PCI Host Bridge Resource Allocation Protocol

Sample Desktop System with One PCI Root Bridge

Figure 9.5 shows an example of a PCI host bus with one PCI root bridge. This PCI root bridge produces one PCI local bus that can contain PCI devices on the motherboard and/or PCI slots. This setup would be typical of a desktop system. In this system, the PCI root bridge needs minimal setup. Typically, the PCI root bridge decodes the following:

- The entire bus range on Segment 0
- The entire I/O space of the processor

- All the memory above the top of system memory

The firmware for this platform would produce the following:

- One instance of the PCI Host Bridge Resource Allocation Protocol
- One instance of PCI Root Bridge I/O Protocol

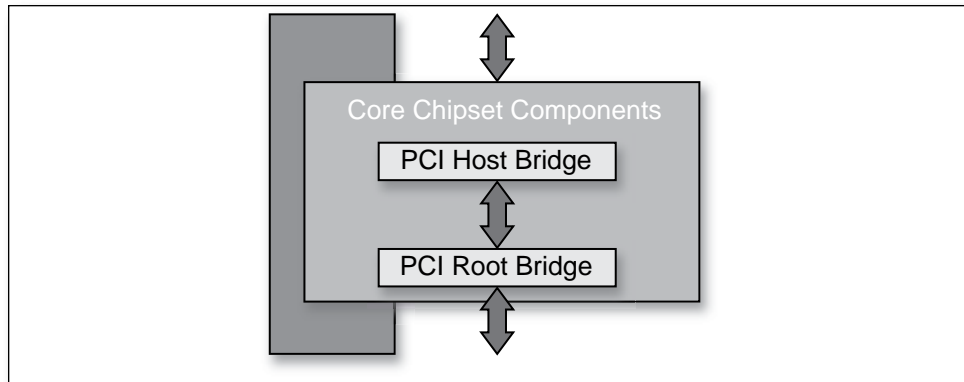

Figure 9.5 Desktop System with One PCI Root Bridge

Sample Server System with Four PCI Root Bridges

Figure 9.6 shows an example of a larger server with one PCI host Bus with four PCI root bridges (RBs). The PCI devices that are attached to the PCI root bridges are all part of the same coherency domain, which means they share the following:

- A common PCI I/O space
- A common PCI memory space
- A common PCI prefetchable memory space

As a result, each PCI root bridge must get resources out of a common pool. Each PCI root bridge produces one PCI local bus that can contain PCI devices on the motherboard or PCI slots. The firmware for this platform would produce the following:

- One instance of the PCI Host Bridge Resource Allocation Protocol
- Four instances of the PCI Root Bridge I/O Protocol

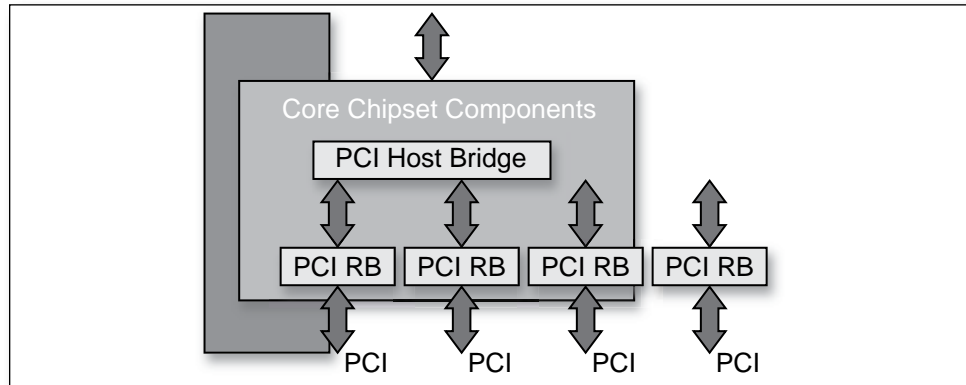

Figure 9.6 Server System with Four PCI Root Bridges

Sample Server System with 2 PCI Segments

Figure 9.7 shows an example of a server with one PCI host bus and two PCI root bridges (RBs). Each of these PCI root bridges is on a different PCI segment, which allows the system to have up to 512 PCI buses. A single PCI segment is limited to 256 PCI buses. These two segments do not share the same PCI configuration space, but they do share the following, which is why they can be described with a single PCI host bus:

- A common PCI I/O space
- A common PCI memory space
- A common PCI prefetchable memory space

The firmware for this platform would produce the following:

- One instance of the PCI Host Bridge Resource Allocation Protocol
- Two instances of the PCI Root Bridge I/O Protocol

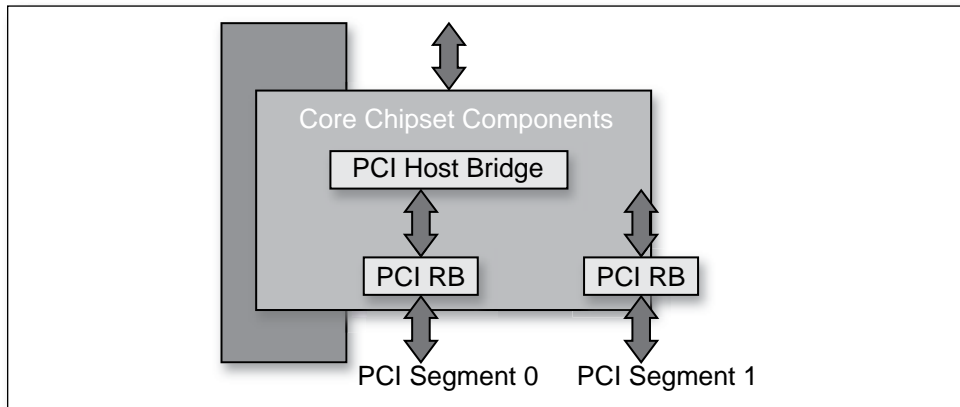

Figure 9.7 Server System with 2 PCI Segments

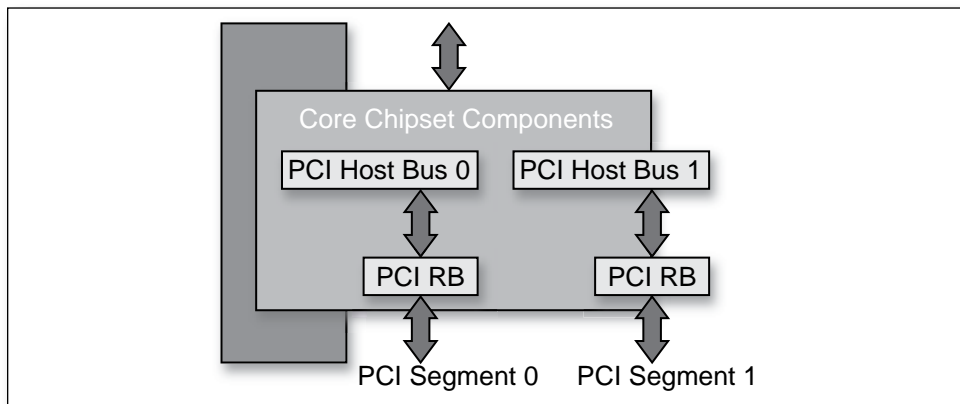

Figure 9.8 Sample Server System with Two PCI Host Buses

Figure 9.8 shows a server system with two PCI host buses and one PCI root bridge (RB) per PCI host bus. Like the server system with 2 PCI segments, this system supports up to 512 PCI buses, but the following resources are not shared between the two PCI root bridges:

- PCI I/O space
- PCI memory space

- PCI prefetchable memory space

The firmware for this platform would produce the following:

- Two instances of the PCI Host Bridge Resource Allocation Protocol
- Two instances of the PCI Root Bridge I/O Protocol

PCI Root Bridge I/O

The interfaces provided in the PCI Root Bridge I/O Protocol are for performing basic operations to memory, I/O, and PCI configuration space. The system provides abstracted access to basic system resources to allow a driver to have a programmatic method to access these basic system resources.

The PCI Root Bridge I/O Protocol allows for future innovation of the platform. It abstracts device-specific code from the system memory map. This allows system designers to make changes to the system memory map without impacting platform-independent code that is consuming basic system resources.

PCI Root Bridge I/O Protocol instances are either produced by the system firmware or by a UEFI driver. When a PCI Root Bridge I/O Protocol is produced, it is placed on a device handle along with an EFI Device Path Protocol instance. The PCI Root Bridge I/O Protocol does not abstract access to the chipset-specific registers that are used to manage a PCI Root Bridge. This functionality is hidden within the system firmware or the UEFI driver that produces the handles that represent the PCI Root Bridges.

Protocol Interface Structure

```
typedef struct _EFI_PCI_ROOT_BRIDGE_IO_PROTOCOL {
    EFI_HANDLE ParentHandle;
    EFI_PCI_ROOT_BRIDGE_IO_PROTOCOL_POLL_IO_MEM PollMem;
    EFI_PCI_ROOT_BRIDGE_IO_PROTOCOL_POLL_IO_MEM PollIo;
    EFI_PCI_ROOT_BRIDGE_IO_PROTOCOL_ACCESS Mem;
    EFI_PCI_ROOT_BRIDGE_IO_PROTOCOL_ACCESS Io;
    EFI_PCI_ROOT_BRIDGE_IO_PROTOCOL_ACCESS Pci;
    EFI_PCI_ROOT_BRIDGE_IO_PROTOCOL_COPY_MEM CopyMem;
    EFI_PCI_ROOT_BRIDGE_IO_PROTOCOL_MAP Map;
    EFI_PCI_ROOT_BRIDGE_IO_PROTOCOL_UNMAP Unmap;
    EFI_PCI_ROOT_BRIDGE_IO_PROTOCOL_ALLOCATE_BUFFER AllocateBuffer;
    EFI_PCI_ROOT_BRIDGE_IO_PROTOCOL_FREE_BUFFER FreeBuffer;
    EFI_PCI_ROOT_BRIDGE_IO_PROTOCOL_FLUSH Flush;
    EFI_PCI_ROOT_BRIDGE_IO_PROTOCOL_GET_ATTRIBUTES GetAttributes;
    EFI_PCI_ROOT_BRIDGE_IO_PROTOCOL_SET_ATTRIBUTES SetAttributes;
    EFI_PCI_ROOT_BRIDGE_IO_PROTOCOL_CONFIGURATION Configuration;
    UINT32 SegmentNumber;
}
```

```
} EFI_PCI_ROOT_BRIDGE_IO_PROTOCOL;
```

- *ParentHandle* – Gives the `EFI_HANDLE` of the PCI Host Bridge of which this PCI Root Bridge is a member.
- *PollMem* – Polls an address in memory mapped I/O space until an exit condition is met, or a timeout occurs.
- *PollIo* – Polls an address in I/O space until an exit condition is met, or a timeout occurs.
- *Mem* – Allows reads and writes for memory mapped I/O space.
- *Io* – Allows reads and writes for I/O space.
- *Pci* – Allows reads and writes for PCI configuration space.
- *CopyMem* – Allows one region of PCI root bridge memory space to be copied to another region of PCI root bridge memory space.
- *Map* – Provides the PCI controller-specific addresses needed to access system memory for DMA.
- *Unmap* – Releases any resources allocated by `Map()`.
- *AllocateBuffer* – Allocates pages that are suitable for a common buffer mapping.
- *FreeBuffer* – Frees pages that were allocated with `AllocateBuffer()`.
- *Flush* – Flushes all PCI posted write transactions to system memory.
- *GetAttributes* – Gets the attributes that a PCI root bridge supports setting with `SetAttributes()`, and the attributes that a PCI root bridge is currently using.
- *SetAttributes* – Sets attributes for a resource range on a PCI root bridge.

- *Configuration* – Gets the current resource settings for this PCI root bridge.
- *SegmentNumber* – The segment number that this PCI root bridge resides.

PCI I/O

The interfaces provided in the PCI I/O Protocol are for performing basic operations to memory, I/O, and PCI configuration space. The system provides abstracted access to basic system resources to allow a driver to have a programmatic method to access these basic system resources. The main goal of this protocol is to provide an abstraction that simplifies the writing of device drivers for PCI devices. This goal is accomplished by providing the following features:

- A driver model that does not require the driver to search the PCI busses for devices to manage. Instead, drivers are provided the location of the device to manage or have the capability to be notified when a PCI controller is discovered.
- A device driver model that abstracts the I/O addresses, Memory addresses, and PCI Configuration addresses from the PCI device driver. Instead, BAR (Base Address Register) relative addressing is used for I/O and Memory accesses, and device relative addressing is used for PCI Configuration accesses. The BAR relative addressing is specified in the PCI I/O services as a BAR index. A PCI controller may contain a combination of 32-bit and 64-bit BARs. The BAR index represents the logical BAR number in the standard PCI configuration header starting from the first BAR. The BAR index does not represent an offset into the standard PCI Configuration Header because those offsets will vary depending on the combination and order of 32-bit and 64-bit BARs.
- The Device Path for the PCI device can be obtained from the same device handle that the PCI I/O Protocol resides.

- The PCI Segment, PCI Bus Number, PCI Device Number, and PCI Function Number of the PCI device if they are required. The general idea is to abstract these details away from the PCI device driver. However, if these details are required, then they are available.
- Details on any nonstandard address decoding that are not covered by the PCI device's Base Address Registers.
- Access to the PCI Root Bridge I/O Protocol for the PCI Host Bus for which the PCI device is a member.
- A copy of the PCI Option ROM if it is present in system memory.
- Functions to perform bus mastering DMA. This includes both packet based DMA and common buffer DMA.

Protocol Interface Structure

```
typedef struct _EFI_PCI_IO_PROTOCOL {
    EFI_PCI_IO_PROTOCOL_POLL_IO_MEM      PollMem;
    EFI_PCI_IO_PROTOCOL_POLL_IO_MEM      PollIo;
    EFI_PCI_IO_PROTOCOL_ACCESS            Mem;
    EFI_PCI_IO_PROTOCOL_ACCESS            Io;
    EFI_PCI_IO_PROTOCOL_CONFIG_ACCESS     Pci;
    EFI_PCI_IO_PROTOCOL_COPY_MEM         CopyMem;
    EFI_PCI_IO_PROTOCOL_MAP               Map;
    EFI_PCI_IO_PROTOCOL_UNMAP            Unmap;
    EFI_PCI_IO_PROTOCOL_ALLOCATE_BUFFER   AllocateBuffer;
    EFI_PCI_IO_PROTOCOL_FREE_BUFFER       FreeBuffer;
    EFI_PCI_IO_PROTOCOL_FLUSH             Flush;
    EFI_PCI_IO_PROTOCOL_GET_LOCATION       GetLocation;
    EFI_PCI_IO_PROTOCOL_ATTRIBUTES        Attributes;
    EFI_PCI_IO_PROTOCOL_GET_BAR_ATTRIBUTES GetBarAttributes ;
    EFI_PCI_IO_PROTOCOL_SET_BAR_ATTRIBUTES SetBarAttributes;
    UINT64                                 RomSize;
    VOID                                    *RomImage;
} EFI_PCI_IO_PROTOCOL;
```

- *PollMem* – Polls an address in PCI memory space until an exit condition is met, or a timeout occurs.
- *PollIo* – Polls an address in PCI I/O space until an exit condition is met, or a timeout occurs.

- *Mem* – Allows BAR relative reads and writes for PCI memory space.
- *Io* – Allows BAR relative reads and writes for PCI I/O space.
- *Pci* – Allows PCI controller relative reads and writes for PCI configuration space.
- *CopyMem* – Allows one region of PCI memory space to be copied to another region of PCI memory space.
- *Map* – Provides the PCI controller-specific address needed to access system memory for DMA.
- *Unmap* – Releases any resources allocated by `Map ()`.
- *AllocateBuffer* – Allocates pages that are suitable for a common buffer mapping.
- *FreeBuffer* – Frees pages that were allocated with `AllocateBuffer ()`.
- *Flush* – Flushes all PCI posted write transactions to system memory.
- *GetLocation* – Retrieves this PCI controller's current PCI bus number, device number, and function number.
- *Attributes* – Performs an operation on the attributes that this PCI controller supports. The operations include getting the set of supported attributes, retrieving the current attributes, setting the current attributes, enabling attributes, and disabling attributes.
- *GetBarAttributes* – Gets the attributes that this PCI controller supports setting on a BAR using `SetBarAttributes ()`, and retrieves the list of resource descriptors for a BAR.
- *SetBarAttributes* – Sets the attributes for a range of a BAR on a PCI controller.

- *RomSize* – Gives the size, in bytes, of the ROM image.
- *RomImage* – Returns a pointer to the in memory copy of the ROM image. The PCI Bus Driver is responsible for allocating memory for the ROM image, and copying the contents of the ROM to memory. The contents of this buffer are either from the PCI option ROM that can be accessed through the ROM BAR of the PCI controller, or from a platform-specific location. The `Attributes()` function can be used to determine from which of these two sources the `RomImage` buffer was initialized.

Block I/O

The Block I/O Protocol is used to abstract mass storage devices to allow code running in the UEFI boot services environment to access them without specific knowledge of the type of device or controller that manages the device. Functions are defined to read and write data at a block level from mass storage devices as well as to manage such devices in the UEFI boot services environment.

The Block interface constructs a logical abstraction of the storage device. Figure 9.9 shows how a typical device that has multiple partitions will have a variety of Block interfaces constructed on it. For example, a partition that is a logical designation of how a disk might be apportioned will have a block interface for it. It should be noted that a particular storage device will have a block interface that has a scope that spans the entire storage device, and the logical partitions will have a scope that is a subset of the device. For instance, in the example shown in Figure 9.8, Block I/O #1 has access to the entire disk, while Block I/O #2 has its first LBA starting at the physical location of the partition it is associated with.

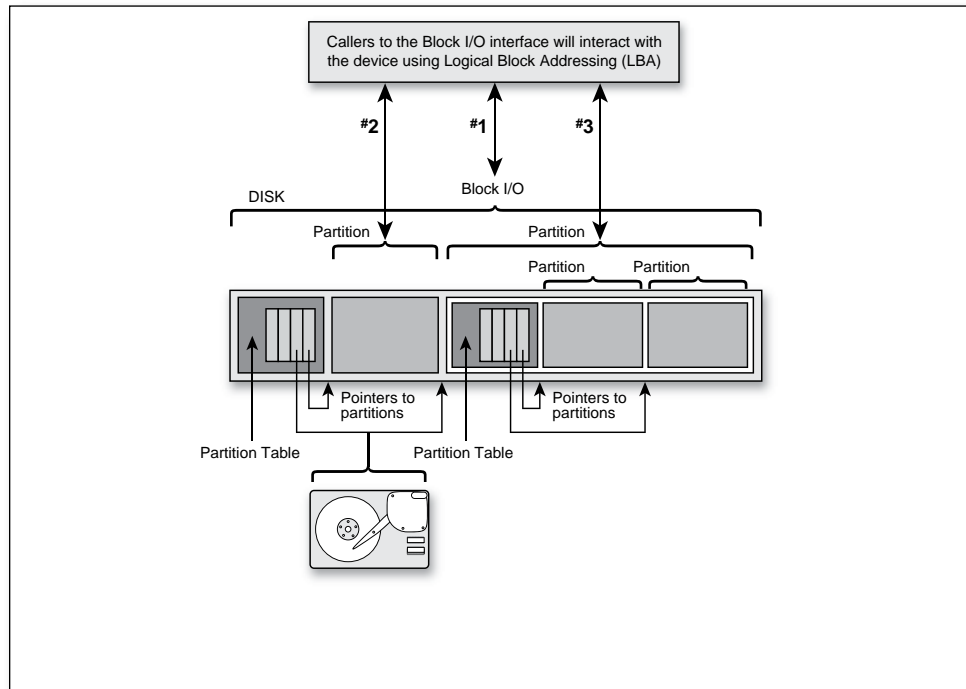

Figure 9.9 Software Layering of the Storage Device

```

Protocol Interface Structure
typedef struct _EFI_BLOCK_IO_PROTOCOL {
    UINT64                Revision;

    EFI_BLOCK_IO_MEDIA    *Media;

    EFI_BLOCK_RESET       Reset;
    EFI_BLOCK_READ        ReadBlocks;
    EFI_BLOCK_WRITE       WriteBlocks;
    EFI_BLOCK_FLUSH       FlushBlocks;
} EFI_BLOCK_IO_PROTOCOL;

```

- *Revision* – The revision to which the block IO interface adheres. All future revisions must be backward compatible. If a future version is not backward compatible it is not the same GUID.

- *Media* – A pointer to the `EFI_BLOCK_IO_MEDIA` data for this device. Type `EFI_BLOCK_IO_MEDIA` is defined in the next code sample.
- *Reset* – Resets the block device hardware.
- *ReadBlocks* – Reads the requested number of blocks from the device.
- *WriteBlocks* – Writes the requested number of blocks to the device.
- *FlushBlocks* – Flushes and cache blocks. This function is optional and only needs to be supported on block devices that cache writes.

```
Protocol Interface Structure
typedef struct {
    UINT32             MediaId;
    BOOLEAN            RemovableMedia;
    BOOLEAN            MediaPresent;

    BOOLEAN            LogicalPartition;
    BOOLEAN            ReadOnly;
    BOOLEAN            WriteCaching;

    UINT32             BlockSize;
    UINT32             IoAlign;

    EFI_LBA            LastBlock;
} EFI_BLOCK_IO_MEDIA;
```

Disk I/O

The Disk I/O protocol is used to abstract the block accesses of the Block I/O protocol to a more general offset-length protocol. The firmware is responsible for adding this protocol to any Block I/O interface that appears in the system that does not already have a Disk I/O protocol. File systems and other disk access code utilize the Disk I/O protocol.

The disk I/O functions allow I/O operations that need not be on the underlying device's block boundaries or alignment requirements. This is done by copying the data to/from internal buffers as needed to provide the proper requests to the block I/O device. Outstanding write buffer data is flushed by using the `Flush()` function of the Block I/O protocol on the device handle.

The firmware automatically adds a Disk I/O interface to any Block I/O interface that is produced. It also adds file system, or logical block I/O, interfaces to any Disk I/O interface that contains any recognized file system or logical block I/O devices. UEFI compliant firmware must automatically support the following required formats:

- The UEFI FAT12, FAT16, and FAT32 file system type.
- The legacy master boot record partition block. (The presence of this on any block I/O device is optional, but if it is present the firmware is responsible for allocating a logical device for each partition).
- The extended partition record partition block.
- The El Torito logical block devices.

The Disk I/O interface provides a very simple interface that allows for a more general offset-length abstraction of the underlying Block I/O protocol.

```
Protocol Interface Structure
typedef struct _EFI_DISK_IO_PROTOCOL {
    UINT64          Revision;
    EFI_DISK_READ   ReadDisk;
    EFI_DISK_WRITE  WriteDisk;
} EFI_DISK_IO_PROTOCOL;
```

- *Revision* – The revision to which the disk I/O interface adheres. All future revisions must be backwards compatible. If a future version is not backwards compatible, it is not the same GUID.
- *ReadDisk* – Reads data from the disk.
- *WriteDisk* – Writes data to the disk.

Simple File System

The Simple File System protocol allows code running in the UEFI boot services environment to obtain file based access to a device. The Simple File System protocol is used to open a device volume and return an EFI File Handle that provides interfaces to access files on a device volume. This protocol is a bit different from most, since its use exposes a secondary protocol that will directly act on the device on top of which the Simple File System was layered. Figure 9.10 illustrates this concept.

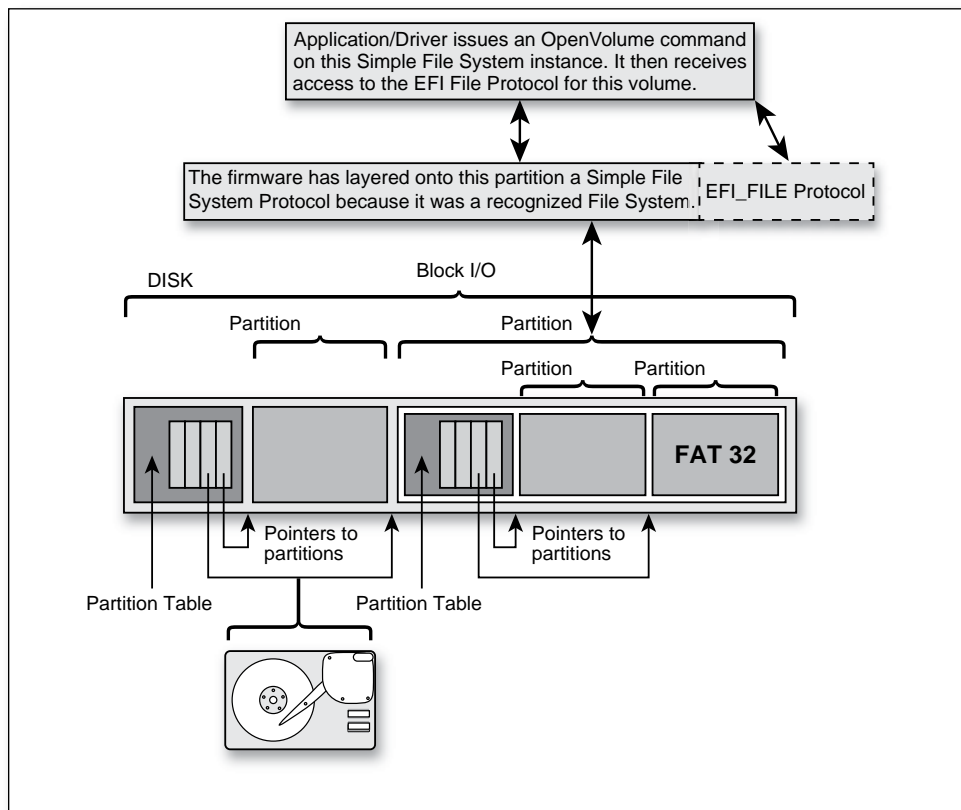

Figure 9.10 Simple File System Software Layering

```
Protocol Interface Structure
typedef struct {
    UINT64          Revision;
    EFI_VOLUME_OPEN OpenVolume;
} EFI_SIMPLE_FILE_SYSTEM_PROTOCOL;
```

- *Revision* – The version of the EFI Simple File System Protocol. The version specified by this specification is 0x00010000. All future revisions must be backward compatible. If a future version is not backward compatible, it is not the same GUID.
- *OpenVolume* – Opens the volume for file I/O access.

EFI File Protocol

On requesting the file system protocol on a device, the caller gets the instance of the Simple File System protocol to the volume. This interface is used to open the root directory of the file system when needed. The caller must `Close()` the file handle to the root directory and any other opened file handles before exiting. While open files are on the device, usage of underlying device protocol(s) that the file system is abstracting must be avoided. For example, when a file system is layered on a `DISK_IO / BLOCK_IO` protocol, direct block access to the device for the blocks that comprise the file system must be avoided while open file handles to the same device exist.

A file system driver may cache data relating to an open file. A `Flush()` function is provided that flushes all dirty data in the file system, relative to the requested file, to the physical medium. If the underlying device may cache data, the file system must inform the device to flush as well.

```
Protocol Interface Structure
typedef struct _EFI_FILE {
    UINT64                Revision;
    EFI_FILE_OPEN         Open;
    EFI_FILE_CLOSE        Close;
    EFI_FILE_DELETE       Delete;
    EFI_FILE_READ         Read;
    EFI_FILE_WRITE        Write;
    EFI_FILE_GET_POSITION GetPosition;
    EFI_FILE_SET_POSITION SetPosition;
    EFI_FILE_GET_INFO     GetInfo;
    EFI_FILE_SET_INFO     SetInfo;
    EFI_FILE_FLUSH        Flush;
} EFI_FILE;
```

- *Revision* – The version of the EFI_FILE interface. The version specified by this specification is 0x00010000. Future versions are required to be back-ward compatible to version 1.0.
- *Open* – Opens or creates a new file.
- *Close* – Closes the current file handle.
- *Delete* – Deletes a file.
- *Read* – Reads bytes from a file.
- *Write* – Writes bytes to a file.
- *GetPosition* – Returns the current file position.
- *SetPosition* – Sets the current file position.
- *GetInfo* – Gets the requested file or volume information.
- *SetInfo* – Sets the requested file information.
- *Flush* – Flushes all modified data associated with the file to the device.

Configuration Infrastructure

The modern UEFI configuration infrastructure that was first described in the UEFI 2.1 specification is known as the Human Interface Infrastructure (HII). HII includes the following set of services:

- *Database Services*. A series of UEFI protocols that are intended to be an in-memory repository of specialized databases. These database services are focused on differing types of information:
 - *Database Repository* – This is the interface that drivers interact with to manipulate configuration related contents. It is most often used to register data and update keyboard layout related information.

- *String Repository* – This is the interface that drivers interact with to manipulate string-based data. It is most often used to extract strings associated with a given token value.
 - *Font Repository* – The interface to which drivers may contribute font-related information for the system to use. Otherwise, it is primarily used by the underlying firmware to extract the built-in fonts to render text to the local monitor. Note that since not all platforms have inherent support for rendering fonts locally (think headless platforms), general purpose UI designs should not presume this capability.
 - *Image Repository* – The interface to which drivers may contribute image-related information for the system to use. This is for purposes of referencing graphical items as a component of a user interface. Note that since not all platforms have inherent support for rendering images locally (think headless platforms), general purpose UI designs should not pre-sume this capability.
- *Browser Services.* The interface that is provided by the platform’s BIOS to interact with the built-in browser. This service’s look-and-feel is implementation-specific, which allows for platform differentiation.
 - *Configuration Routing Services.* The interface that manages the movement of configuration data from drivers to target configuration applications. It then serves as the single point to receive configuration information from configuration applications, routing the results to the appropriate drivers.
 - *Configuration Access Services.* The interface that is exposed by a driver’s configuration handler and is called by the configuration routing services. This service abstracts a driver’s configuration settings and also provides a means by which the platform can call the driver to initiate driver-specific operations.

Using the Configuration Infrastructure

The overview introduced the components of the UEFI configuration infrastructure. This section discusses with a bit more detail how one goes about using aspects of this infrastructure. The following steps are initiated by a driver that is concerned with using the configuration infrastructure:

- *Initialize hardware.* The primary job of a device driver is typically to initialize the hardware that it owns. During this process of physically initializing the device, the driver is also responsible for establishing the proper configuration state information for that device. These typically include doing the following:
 - *Installing required protocols.* Protocols are interfaces that will be used to communicate with the driver. One of the more pertinent protocols associated with configuration would be the Configuration Access protocol. This is used by the system BIOS and agents in the BIOS to interact with the driver. This is also the mechanism by which a driver can provide an abstraction to a proprietary nonvolatile storage that under normal circumstances would not be usable by anyone other than the driver itself. This is how configuration data can be exposed for add-in devices and others can send configuration update requests without needing direct knowledge of that device.
 - *Creating an EFI device path on an EFI handle.* A device path is a binary description of the device and typically how it is attached to the system. This provides a unique name for the managed device and will be used by the system to refer to the device later.
- *Register Configuration Content.* One of the latter parts of the driver initialization (once a device path has been established) is the registration of the configuration data with the underlying UEFI-compatible BIOS. The configuration data typically consists of sets of forms and strings that contain sufficient information for the platform to render pages for a user to interact with. It should also be noted that now that the configuration data is encapsulated in a binary format, what was previously an opaque meaningless set of data is now a well-known and exportable set of data that greatly expands the configurability of

the device by both local and remote agents as well as BIOS and OS-present components.

- *Respond to Configuration Event.* Once the initialization and registration functions have completed, the driver could potentially remain dormant until called upon. A driver would most often be called upon to act on a configuration event. A configuration event is an event that occurs when a BIOS component calls upon one of the interfaces that the driver exposed (such as the Configuration Access protocol) and sends the driver a directive. These directives typically would be something akin to “give me your current settings” or “adjust setting X’s value to a 5”.

Much more detail on this particular infrastructure is covered later in the book.

Driver Model Interactions

The drivers that interact with the UEFI configuration infrastructure are often compliant with the UEFI driver model, as the examples shown in Figure 9.11 and Figure 9.12. Since driver model compliance is very common (and highly recommended) for device drivers, several examples are shown below that describe in detail how such a driver would most effectively leverage the configuration infrastructure.

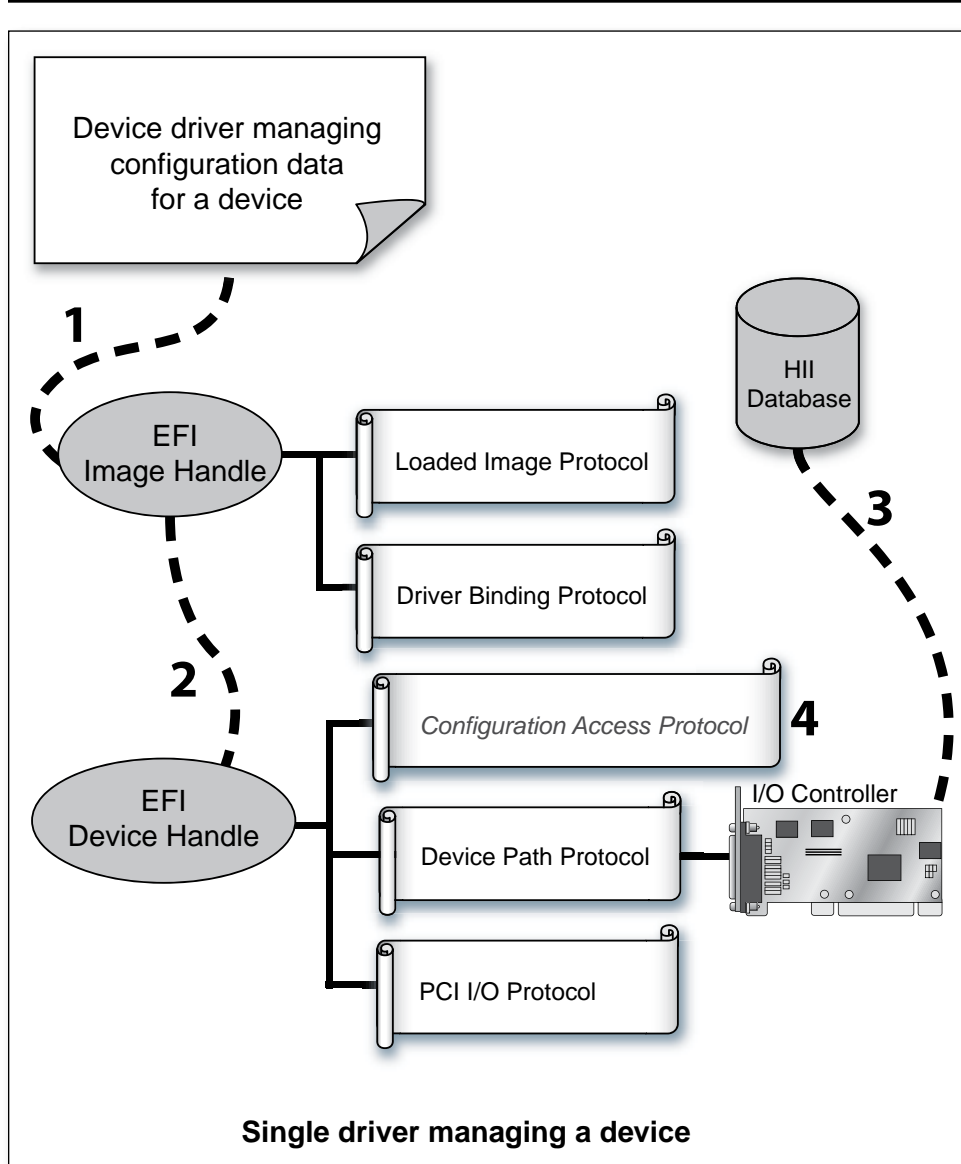

Figure 9.11 A Single Driver that Is Registering Its Configuration Data and Establishing Its Environment in a Recommended Fashion

- *Step 1.* During driver initialization, install services on the controller handle.

- *Step 2.* During driver initialization, discover the managed device. Create a device handle and then install various services on it.
- *Step 3.* During driver initialization, configuration data for the device is registered with the HII database (through the `NewPackageList()` API) using the device's device handle. A unique HII handle is created during the registration event.
- *Step 4.* During system operation, when a configuration event occurs, the system addresses (through the Configuration Access protocol) the configuration services associated with the device.

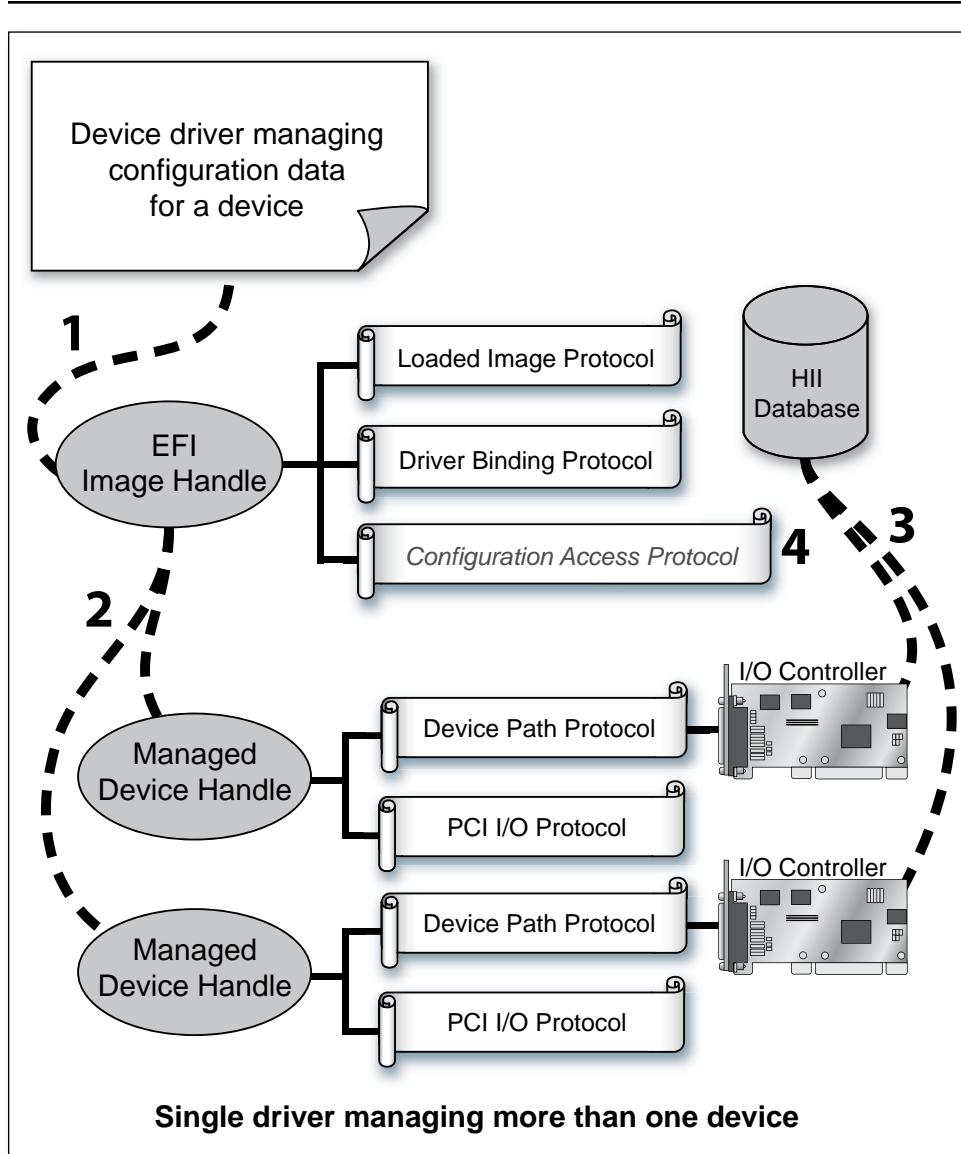

Figure 9.12 A Single Driver that Is Managing Multiple Devices, Registering Its Configuration Data, and Establishing Its Environment in a Recommended Fashion

- *Step 1.* During driver initialization, install services on the controller handle.

- *Step 2.* During driver initialization, discover the managed device(s). Create device handle(s) and then install various services on them.
- *Step 3.* During driver initialization, configuration data for each device is registered with the HII database (through the `NewPackageList()` API) using each device's device handle. A unique HII handle is created during the registration event.
- *Step 4.* During system operation, when a configuration event occurs, the system addresses (through the Configuration Access protocol) the configuration services associated with the driver. In this example, the configuration services will be required to disambiguate references to each of its managed devices by the passed in HII handle.

Provisioning the Platform

Figure 9.13 is an illustration that builds on the previously introduced concepts and shows how the remote interaction would introduce the concept of bare-metal provisioning (putting content on a platform without the aid of a formal operating system). This kind of interaction could be used in the manufacturing environment to achieve the provisioning of the platform or in the after-market environment where one is remotely managing the platform and updating it.

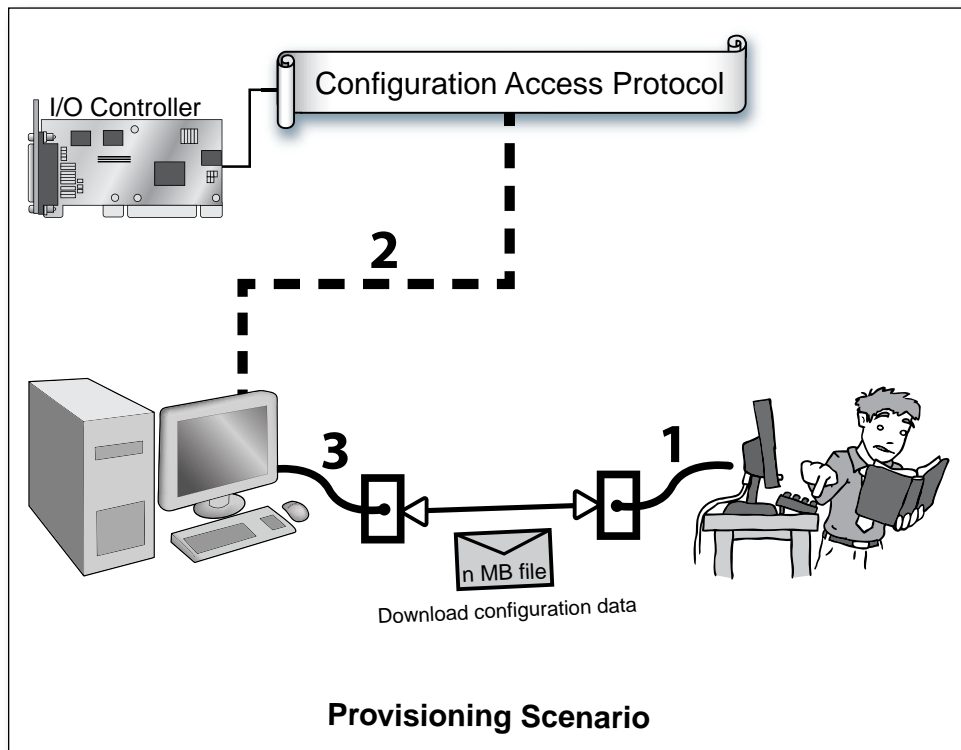

Figure 9.13 Remote Interaction Occurs with a Target System; the System in Turn Accesses the Configuration Abstractions Associated with a Device or Set of Devices

- *Step 1.* Remote administrator sends a query to a target workstation. This query could actually be a component of a broadcast by the administrator to all members of the network.
- *Step 2.* Request received and an agent (possibly a shell-based one) proxies the request to the appropriate device.
- *Step 3.* The agent responds based on interaction with the platform's underlying configuration infrastructure.



Summary

In conclusion, this chapter describes a series of the common protocols one would encounter in a UEFI enabled platform, and also highlights the common scenarios where one would leverage their use. With these protocols, one should be armed well for the future environments (both hardware and software) that will be encountered as the platform ecosystem evolves.

Chapter 10

Platform Security and Trust

We will bankrupt ourselves in the vain search for absolute security.

—Dwight D. Eisenhower

The Unified Extensible Firmware Interface (UEFI) and Platform Initialization (PI) specifications describe the platform elements that take control of the system across the various restart events. These elements are also responsible for ceding control to hypervisors, operating systems, or staying in the UEFI boot services environment as the “runtime.” These modules and drivers can provide support for various secure boot and trusted computing scenarios.

Beyond the feature drivers and boot flow, the UEFI and PI specifications describe interfaces and binary image encoding of executable modules for purposes of interoperability. This allows for business-to-business engagements, such as a chipset or CPU vendor providing drivers to a system board vendor for purposes of building a whole solution. This is the positive side of the extensibility. The darker side of extensibility, though, entails the need to have some assurance that the final system board design meets various security goals, such as integrity, availability, and confidentiality. In other words, how can the platform manufacturer who ships a system board have confidence that the UEFI and PI modules have been safely composed?

This chapter describes some of the security and trusted computing capabilities. Then it discusses how to construct and integrate elements.

Trust Overview

We begin the discussion of trusted platforms with some background on trust—specifically, the definition of *trust*, and some related concepts, *measurement* and *security*:

- *Trust*. An entity can be trusted if it always behaves in the expected manner for the intended purpose.
- *Measurement*. The process of obtaining the identity of an entity.
- *Security*. Maintenance that ensures a state of inviolability from hostile acts or influences (from <http://www.thefreedictionary.com/security>).

In fact, trust is an amalgam of several elements of the platform that span the enterprise to consumer, including reliability, safety, confidentiality, integrity, and availability, as illustrated in Figure 10.1.

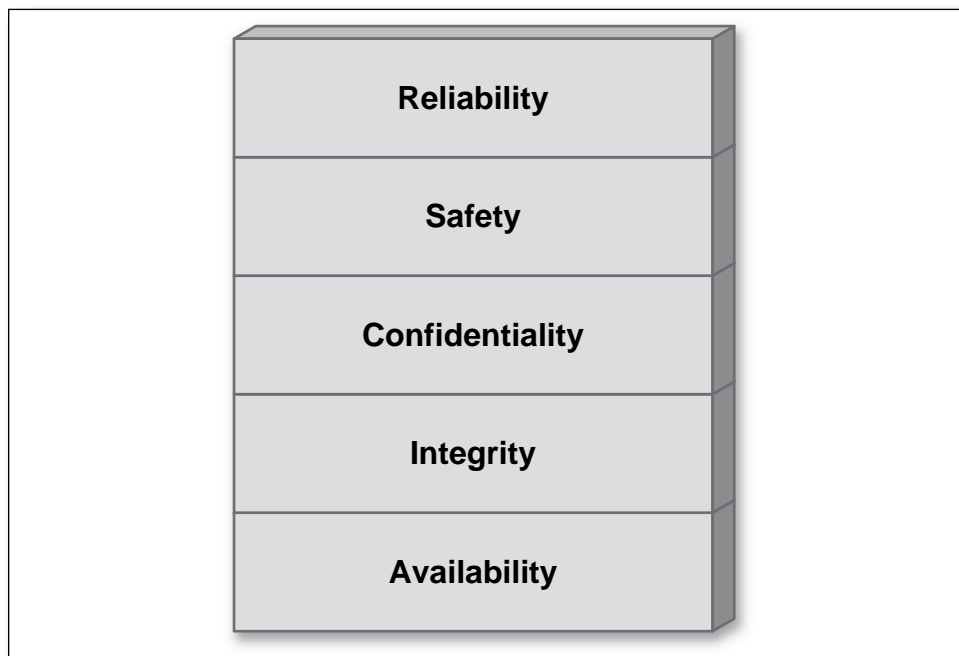

Figure 10.1 The Elements of Trust

Where should the solution reside, given the problems to be solved and some of the capabilities like security, trust, and measurement to help effect the solution?

In fact, the implementation of trust and security entail a security architecture that spans the entire system, starting at the base with hardware and spanning all of the way to the end-user application.

Figure 10.2 shows all of the layers of a security architecture. The network layer is broken out with a few examples, such as protocols (SSL, IPsec); this chapter does not delve too deeply into this layer. The firmware layer is highlighted to show that a single-layer of security is not sufficient.

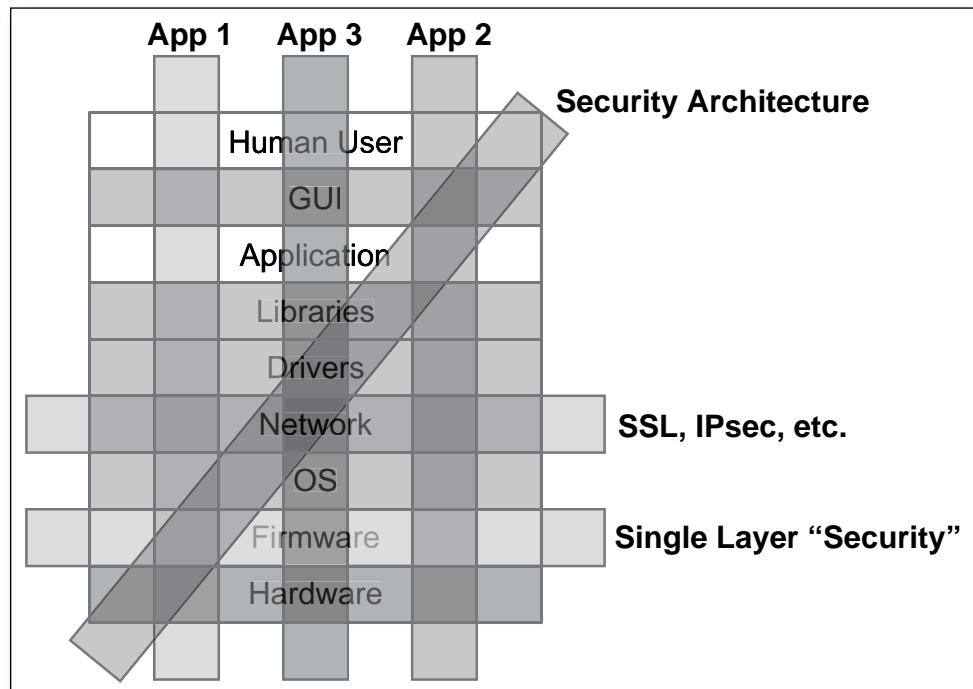

Figure 10.2 All Layers of a Security Architecture

In fact, the scope of this chapter largely treats firmware. Some description of hardware elements and interaction are provided. Figure 10.3 highlights the area that this chapter discusses in more depth.

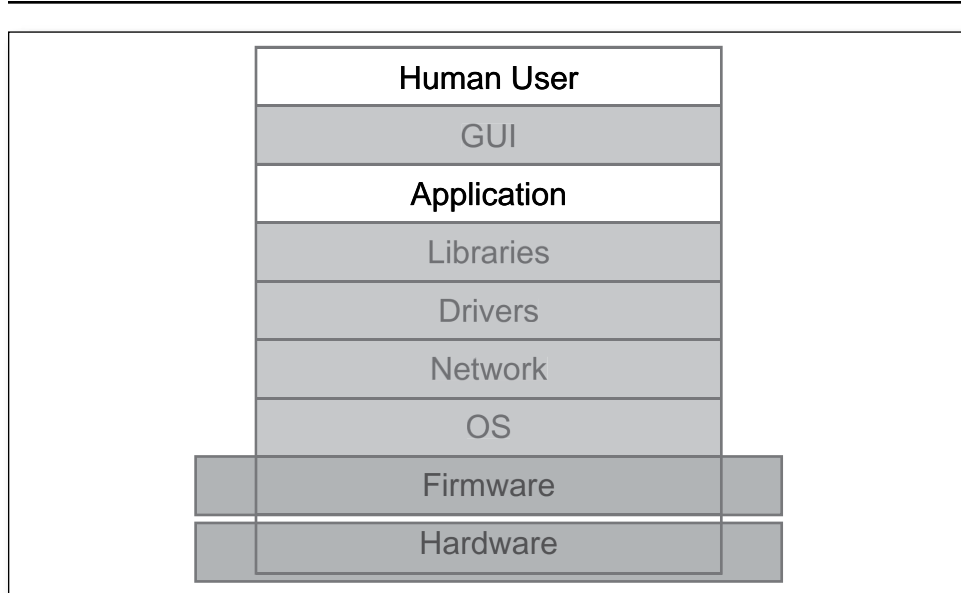

Figure 10.3 Layers Examined in this Chapter

As seen in Figure 10.3, all layers are important, but if you do not have firmware/hardware assurance, you cannot have a security architecture. As the logicians would say, it's “necessary but not sufficient” to have appropriate design in these layers. And as will be described later, the layer of hardware and firmware provide a “root of trust” for the rest of the security architecture.

So now that we have trust, security, measurement, and a layered picture of the security architecture, the goals of the security architecture and assets that are protected are as follows.

The first security goal is *integrity*, and this entails the protection of content and information from unauthorized modification. The next goal is *authenticity*, and this provides guarantee or assurance in the source of the code or data. Another important goal is *availability*, or the ability to ensure behavior and the responsiveness of the system. Availability also protects from destruction or denial of access. And finally, another goal is *confidentiality*, or the protection of information from unauthorized access.

Through the subsequent discussion of trusted platforms and UEFI, some of these integrity, authenticity, and availability goals will be discussed in more detail.

It is outside the scope of this chapter to describe confidentiality since this is typically a concern of higher-level applications, but errors in lower layers of the trusted platform may imperil this goal. Specifically, this relates to the introduction of vulnerability via a flaw in integrity or authenticity implementations of a layer that wants to provide confidentiality (say an application) when the hardware or firmware or network underneath is errant.

A final item that is discussed in this chapter is a final goal that spans all of the above, namely *assurance*. By assurance we mean having some guarantee of the correctness of an implementation. And for this study, assurance will be treated in detail for the case when platform firmware and trusted computing hardware elements are the embodiment of the platform.

And given the trust definition above, we see that these features are especially important in the enterprise, such as a high-end server, where reliability and safety goals are co-equal to the other concerns like integrity and confidentiality.

Trusted Platform Module (TPM) and Measured Boot

In building out the hardware layer of the security architecture, one problem with open platforms is that there hasn't been a location on the system to have a root of trust. The trusted platform module (TPM) and the infrastructure around this component are an industry attempt to build a series of roots of trust in the platform.

The maintenance and evolution of the capabilities of the TPM are managed through an industry standards body known as the Trusted Computing Group (TCG). The TCG members include systems manufacturers, TPM manufacturers, CPU and chipset vendors, operating system vendors, and other parties that contribute hardware and software elements into a trusted platform. HP and IBM are examples of vendors that span many of these categories. Intel also participates in the TCG as CPU and chipset vendor.

To begin, what is a trusted platform module? It features a series of protected regions and capabilities. Typically, a TPM is built as a microcontroller with integrated flash/storage that is attached to the LPC bus on PC, but it can also be a virtual device or more deeply integrated in the platform chipset complex. The TPM interacts with the system through a host interface. The TPM Interface Specification (TIS) in the TCG PC Client working group describes the memory-mapped I/O interfaces; the TIS is just one such interface. The TPM main specification describes the *ordinals* or the byte stream of commands that are sent into the TPM. These commands are the required actions that a

TPM must carry out in service of the host. Figure 10.4 shows some of the specifications that describe the TPM and its integration into the platform.

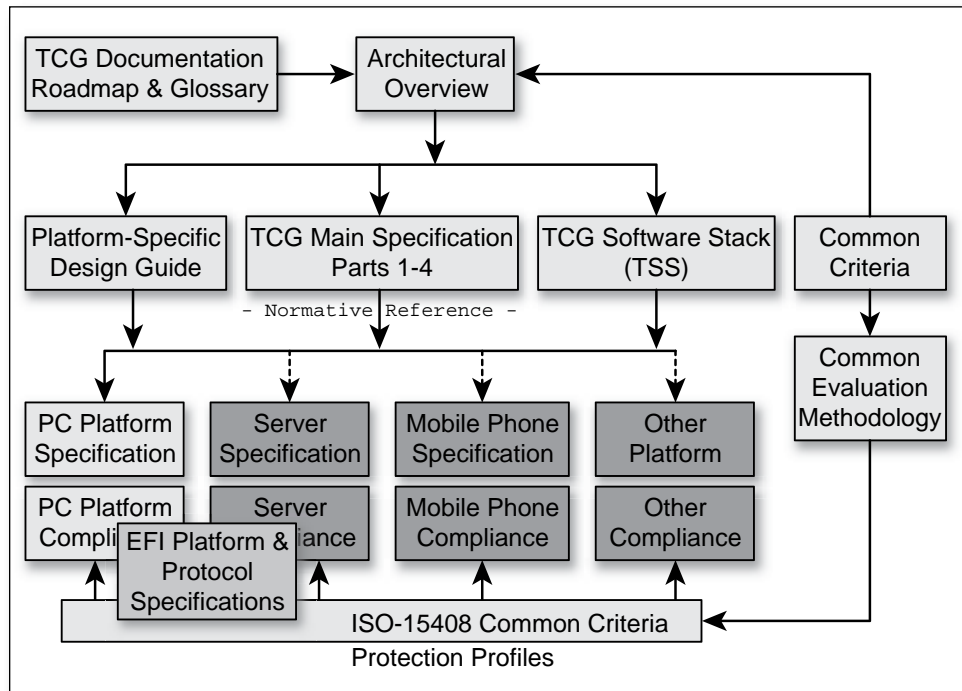

Figure 10.4 TCG Specification Hierarchy

The interoperability of the Trusted Computing elements is managed through the Trusted Computing Group (TCG) and a series of specifications. For purposes of this review, the TPM main specification, platform design guides, protection profiles, and the UEFI collateral will be of interest, as highlighted above.

Figure 10.6 shows an instance of a TPM diagrammatically. Given the existence of the specifications mentioned earlier, multiple vendors can provide conformant instances of this technology with the ability to differentiate their implementations.

- **TCG Defines TPM's Functionality**

- **Protected Capabilities**
- **Shielded Locations**

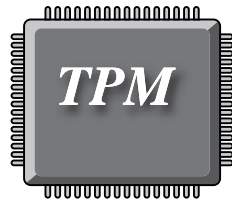

- **Not the Implementation**

- **Vendors are free to differentiate the TPM implementation**
- **Must still meet the protected capabilities and shielded locations requirements**

Figure 10.5 TPM Overview

Figure 10.6 is a picture of the elements that are typically found within a TPM. The protected execution and storage of the TPM allow for hosting the RSA asymmetric key pairs, such as the endorsement key (EK), the attestation identity key (AIK), and storage root keys (SRKs). Recall that in RSA cryptography, the public key can be known to all, but the private key must be shrouded from users. The TPM and its isolated execution can both host the key-pairs and keep the private RSA keys away from attacks/errant agents on the host. In today's platforms without a TPM, only a custom hardware security module (HSM) or other additional hardware can be used for hosting key-pairs. But in these latter solutions, there is no guarantee on construction of platform, surety of the host interface, and so on. The Trusted Computing Group attempts to both describe the requirements on the TPM and the binding into the platform in order to have a trusted building block (TBB) via design guides, protection profiles, conformance tests, and so on.

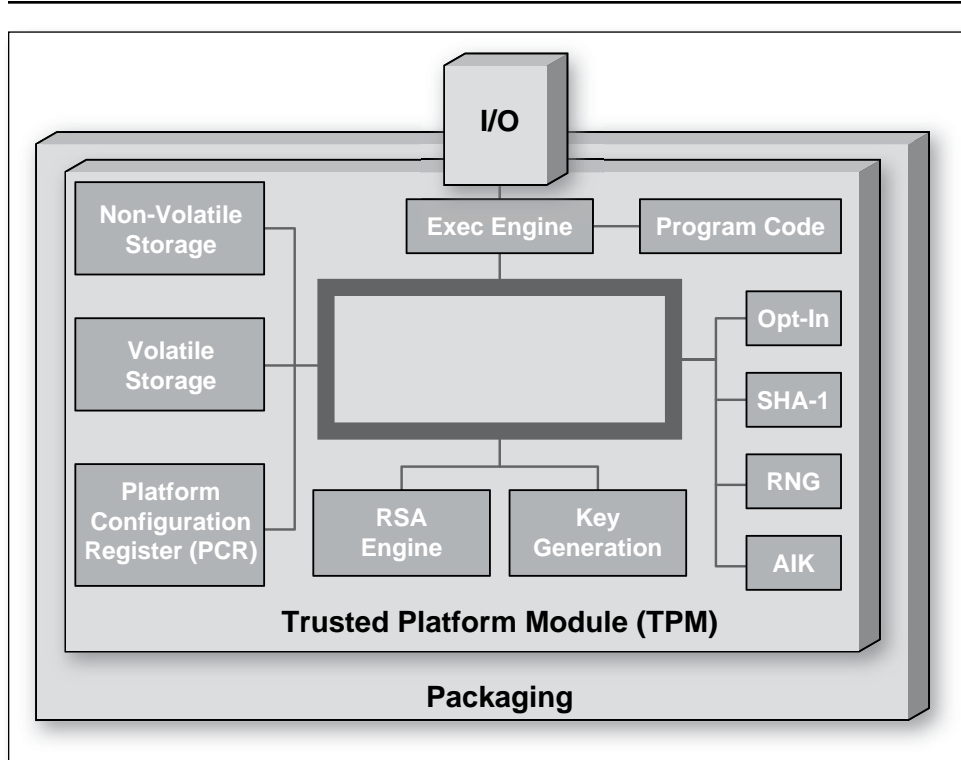

Figure 10.6 TPM Block Diagram

What Is a Trusted Building Block (TBB)?

The TBB includes the components that make up the platform. These can include the TPM, how the TPM is bound to the platform, flash with the system board firmware, and portions of the firmware that must be trusted. The TBB goes beyond TPM ordinals. It leads into prescriptions on the construction of the physical platform. As such, it is not just an issue at one layer of the stack.

A S-CRTM is a “static core root of trust for measurement.” The S-CRTM is the portion of the platform firmware that must be “implicitly trusted.” The S-CRTM makes the first measurements, starts TPM, and detects physical presence per the TCG privacy model.

And it is where the S-CRTM portion of the TBB intersects with the platform firmware and other roots-of-trust in the platform. S-CRTM, CRTM, and SRTM are used interchangeably later in the section.

Following is a quick overview to clarify the roots-of-trust in the platform and which business entity delivers them.

Taxonomy of terms in the platform:

■ RTM

- Generic term for “Root of Trust for Measurement”
- SRTM is the static root of trust for measurement (SRTM) – CRTM + unbreakable measurement chain to OS
- DRTM is the dynamic root of trust for measurement (DRTM)

■ CRTM

- Static CRTM (S-CRTM) or CRTM. Portion of platform firmware that must be implicitly trusted.

■ RTR

- Root of trust for Reporting
- These are the Platform Configuration Registers (PCRs) in the TPM
- 20-byte non-resettable registers to store the *state* or *measurements* of code + data
- Typically SHA1 (new info || former PCR value), where “||” is the catenation of data

■ RTS

- Root of trust for storage
- Endorsement key (EK) – unique per TPM
- Storage root keys (SRKs) – used by OS and others to build key hierarchies

■ TPM Owner

- Applies the authentication value
- Several commands are “owner authorized”

■ SRTM

- Static root of trust for measurement
- CRTM (CRTM) + platform firmware measuring all code and data prior to boot
- Records information into non-resettable or “static” PCRs (0-15); Described by TCG BIOS and UEFI specifications

■ DRTM

- Dynamic root of trust for measurement
- Initiate the measurement later in boot. Includes resettable PCRs 16 and above; these resettable PCRs zeroed upon initiation of the DRTM launch

■ Physical presence

- Administrative model of the TPM. Assertion by operator of presence in order to perform privacy or administrative activities with the TPM.

In general, a hardware instantiation of the trusted platform module (TPM) is a passive hardware device on the system board. It serves as the root of trust for storage (RTS) and root of trust for reporting (RTR). The former is the use of the storage root key (SRK) and the Platform Configuration Registers (PCRs). Figure 10.7 shows the synthesis of the various roots in the platform.

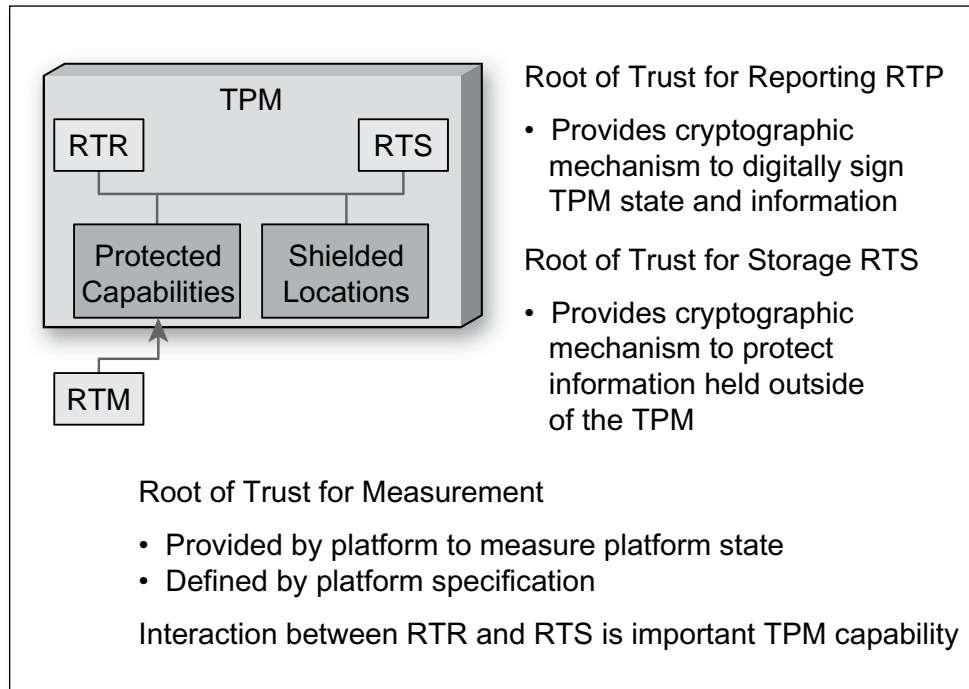

Figure 10.7 Functions of a TPM

The active agent on the platform is the root of trust for measurement (RTM). The RTM can be either static or dynamic (SRTM versus DRTM, respectively). The SRTM, on the other hand, entails the creation of a trust chain from the platform reset vector going forward.

The definition of the SRTM for UEFI is defined in the UEFI TCG Protocol Specification and the TCG UEFI Platform Specification. The flow of the SRTM into the operating system is shown in Figure 10.8.

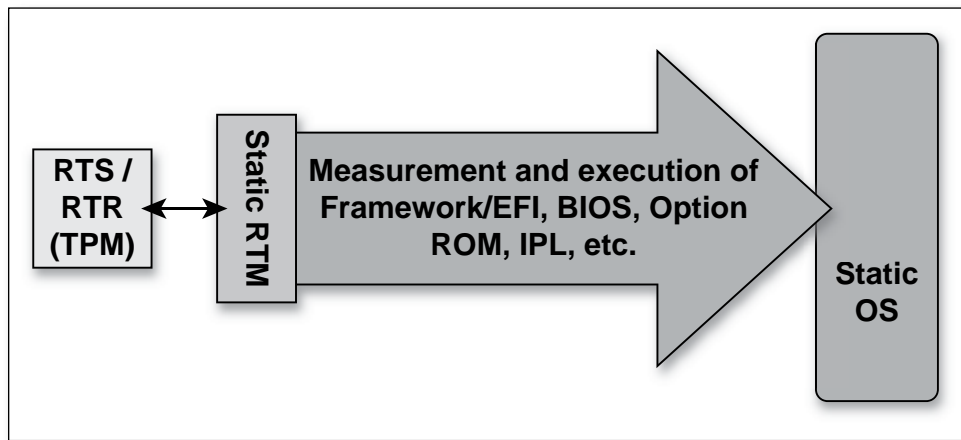

Figure 10.8 Boot Flow that Includes a Static Root of Trust

There need to be UEFI APIs available so that the UEFI OS loader can continue to measure the operating system kernel, pass commands to the TPM to possibly unseal a secret, and perform other TPM actions prior to the availability of the OS TPM driver. In addition, this API can be installed at the beginning of DXE to enable measurement of the DXE and UEFI images. Figure 10.9 shows where the UEFI TCG APIs would appear relative to the other interfaces.

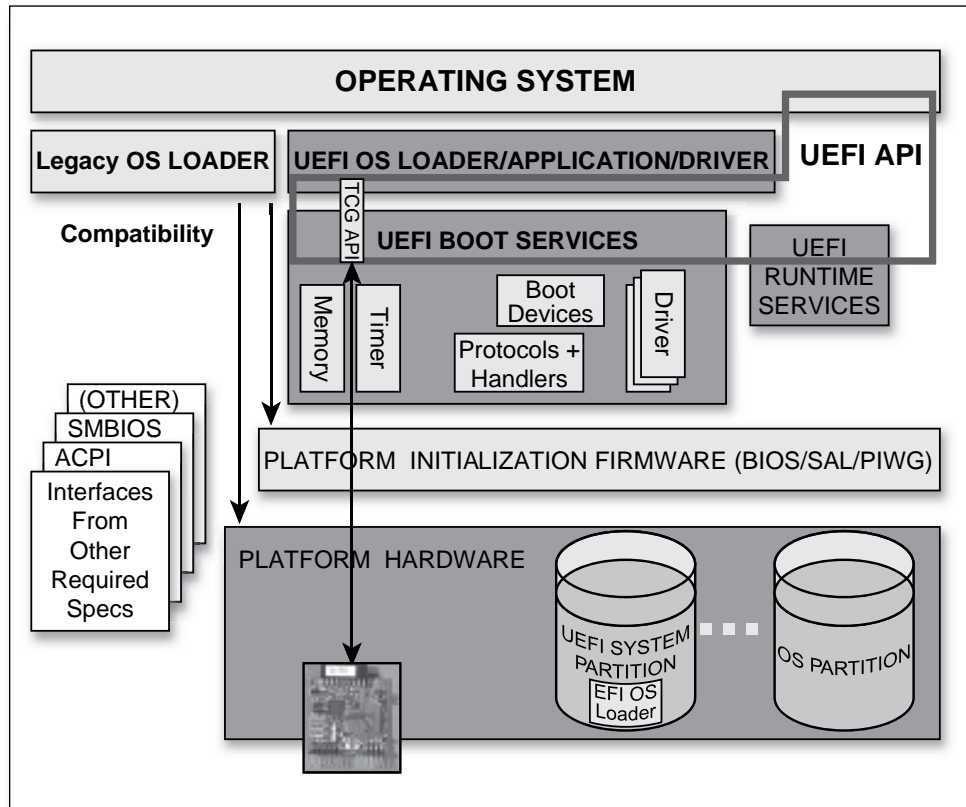

Figure 10.9 UEFI API Layering

The UEFI specifications are cross-listed in the TCG PC and Server Working Groups such that both consumer and enterprise-class operating systems can participate in this boot flow behavior.

The UEFI TCG Platform specification describes which objects to measure in a UEFI system, such as the images, on-disk data structures, and UEFI variables. Figure 10.10 shows which objects in a UEFI system correspond to measures in PCRs.

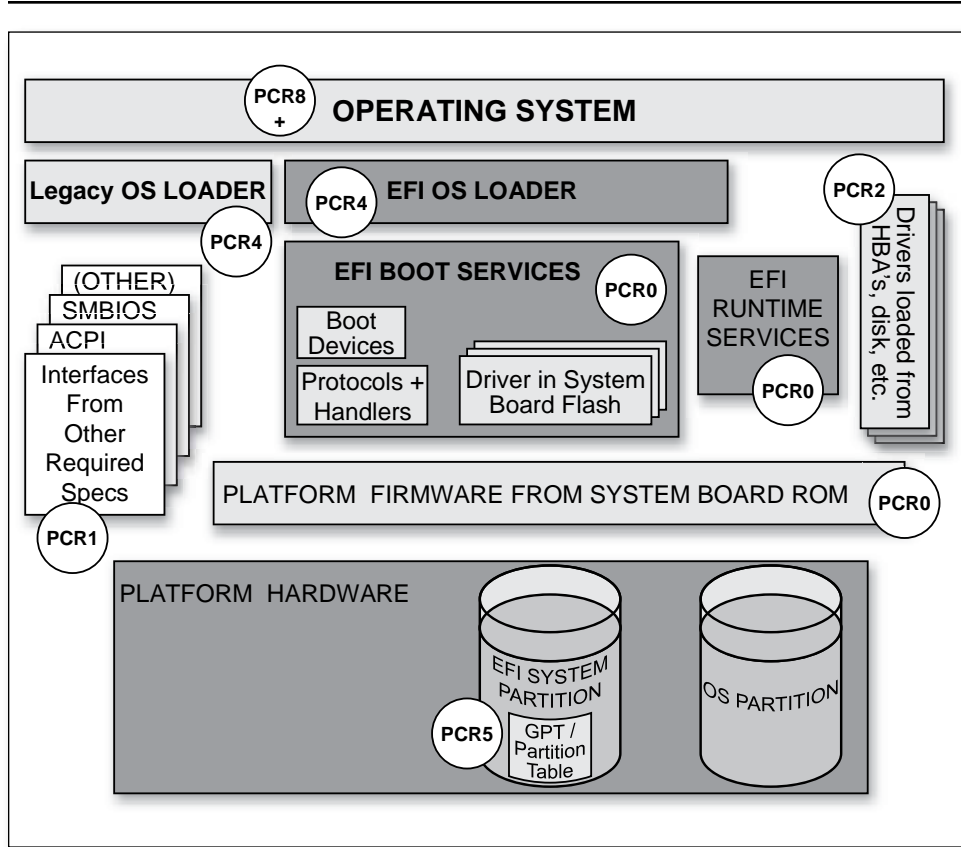

Figure 10.10 Measured Objects in UEFI

Prior to the UEFI phase of platform execution, the PI describe the PEI and DXE phases. In these phases the CRTM is mapped to the PEI phase and what is thought of as BIOS POST is mapped to DXE. There are interfaces in PEI (namely, the PEIM-to-PEIM interface, or PPI) to allow for fine-grain measurement in that phase of execution, too. Figure 10.11 shows one possible PEI-based CRTM and the flow into the operating system.

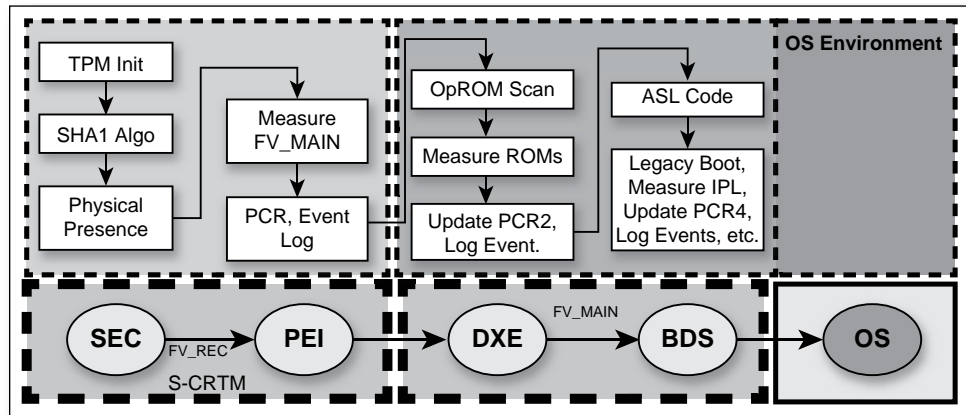

Figure 10.11 SRTM Boot Flow

What Is the Point of Measurements?

The process of measurements records the state of the platform, for both executable code and data hashes, into the TPM’s platform configuration registers (PCRs). These PCRs are write-only and cleared upon a platform reset (at least the static PCRs for SRTM). The PCRs reflect the platform state. They are used such that software, when installed upon the platform, can “seal” some information to the platform. A Seal operation is like an encryption that also includes PCRs. There is a corresponding Unseal operation, which is a decryption that also uses the PCRs.

What this practically means is that if the state of the platform changes between the installation of some software (and the Seal operation) and successive invocations of software on later restarts (and the use of Unseal operation), unauthorized changes to the platform in the interim will be detected (that is, PCRs changed).

This is sort of the Resurrecting Duckling security model wherein the initial state of the platform (that is, PCR values upon installing application) is considered safe or acceptable.

UEFI offers an opportunity here. PI and UEFI have specification-based components written in a high-level language (for example, C). The software development lifecycle (SDL) for drivers and other system software can be applied, as can static analysis tools (such as Klockwork[†] and Coverity[†]). Later

in the chapter we'll talk about additional practices to complement the SDL that address domain-specific issues with platform firmware.

With all these elements of security and protections in place how the CRTM is updated becomes critical and much more challenging. Since the CRTM is the root, and is itself inherently trusted, it must be a very controlled and secure process. The TCG describes CRTM maintenance in the Trusted Building Block (TBB) protection profile. Either the CRTM is immutable, or never changed in the field, or appropriate cryptographic techniques need to be employed in order to update the CRTM.

Regarding the cryptographic-based update, Figure 10.12 shows a possible implementation where the firmware volume (FV) update is enveloped using an RSA-2048/SHA-256-based update. This is just one possible UEFI PI implementation that leverages the UEFI PI-based firmware volume construct and the WIN_CERT that can be found in the UEFI 2.0 specification.

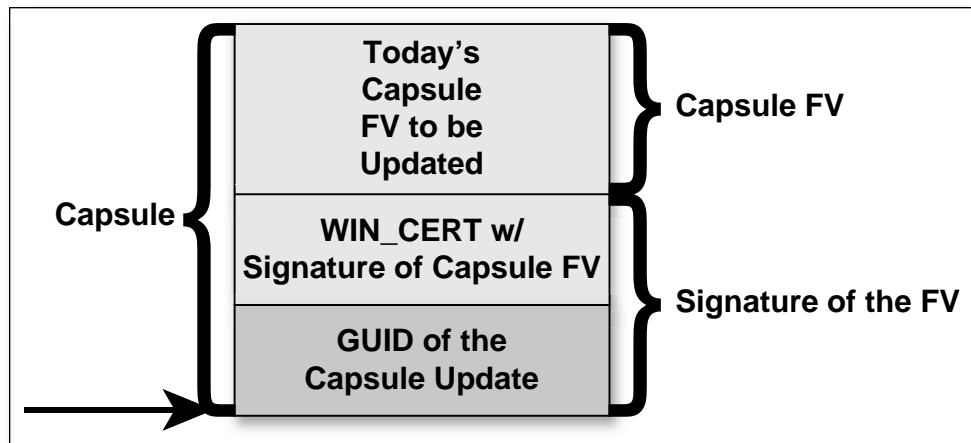

Figure 10.12 Firmware Volume Update

As noted above, a signed capsule is one implementation path. The system flash is not directly updated by a flash utility but instead the CRTM update capsule is stored in a staging area. The next time the CRTM gains control of the system (at reset), it will check for any pending updates. If updates are found, they will be validated and then cryptographically verified. If they are valid, the CRTM update can be applied. It's important to note that when validating the update this all must be done by using only CRTM code and data. Code or data outside the CRTM cannot be trusted until verified.

UEFI Secure Boot

There are several terms that will be introduced in the context of UEFI and trust. These include *executable verification*, *driver signing*, *user identification*, *network authentication*, and *network security*.

To begin, the UEFI evolution described below appear as elements of the UEFI main specification in version 2.3. These features entail updates to the boot behavior and the features briefly treated will include image verification, networking enhancements such as IPSec, and user identification.

Figure 10.13 shows where in the stack the emergent UEFI features described in this chapter exist, namely in the UEFI Services and boot manager.

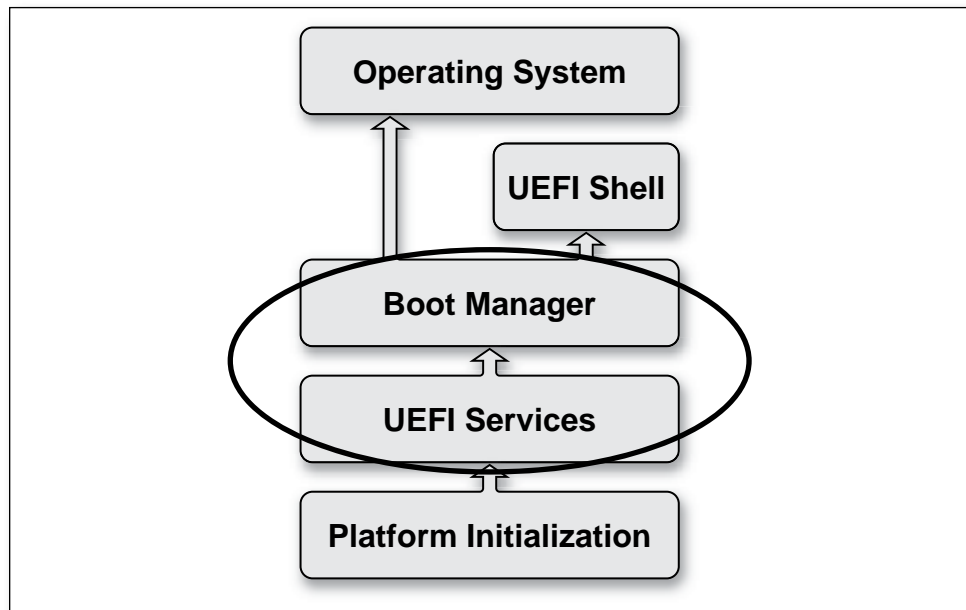

Figure 10.13 UEFI Software Stack

UEFI Executable Verification

The first feature from UEFI to discuss is driver signing or executable verification. Driver signing:

- Expands the types of signatures recognized by UEFI
 - SHA-1, SHA-256, RSA2048/SHA-1, RSA2048/SHA-256 and Authenticode
- Standard method for configuring the “known-good” and “known-bad” signature databases.
- Provides standard behavior when execution is denied to provide policy-based updates to the lists.

One evolution beyond the SRTM described in earlier chapters, is that UEFI can provide “verification.” Recall that the SRTM records the state of the code and data in the platform such that a later entity may assess the measurements. For verification, or enforcement, of some policy, the UEFI firmware can act as a root-of-trust-for-enforcement (RTE) or root-of-trust-for-verification (RTV) wherein the boot process can change as part of policy. This policy can include the UEFI image verification using Authenticode-signed images, for example.

Figure 10.14 shows the steps necessary for signing of UEFI images. The signing can include RSA asymmetric encryption and the hash function a member of the security hash algorithm family.

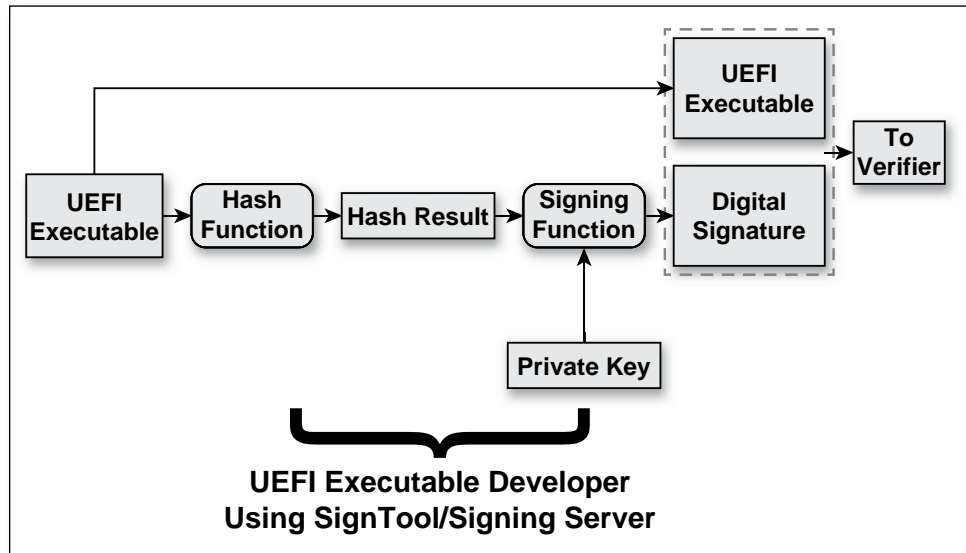

Figure 10.14 Driver Signing

This preparation would happen at the manufacturer facility or could be facilitated by a third party, such as VeriSign[†] Certificate Authority (CA).

Once the signed images are deployed in the field, whether loaded across the network, from a host-bus adapter card, or via the UEFI system partition, the UEFI 2.3 firmware verifies the image integrity, as illustrated in Figure 10.15.

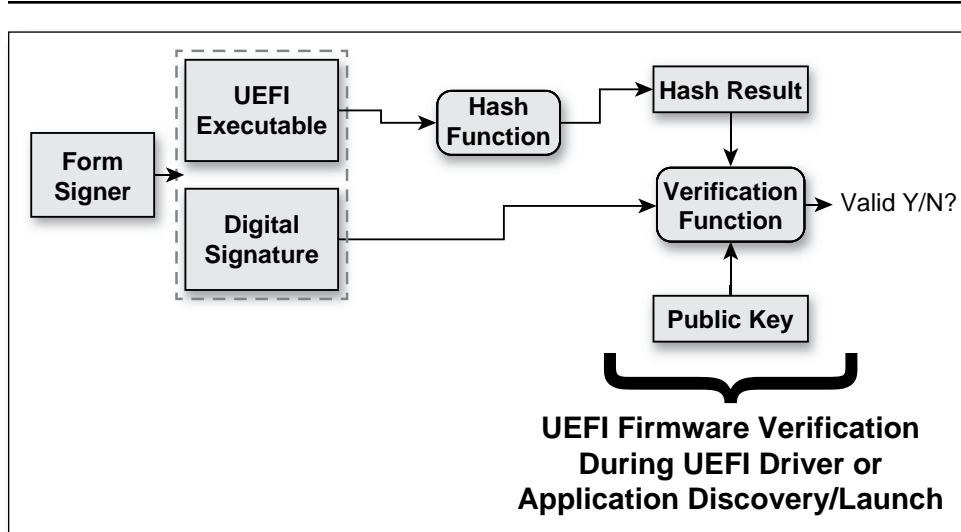

Figure 10.15 Verification of UEFI Images

The combination of robust UEFI implements and interoperable trust infrastructure will allow for evolving the extensibility of UEFI in a safe, robust fashion.

UEFI Networking

Another element that appears in UEFI entails additional network security, including IPsec support. Trusted hardware like the TPM can be used to help store the IPsec credentials, but to be stronger, assurance around the UEFI firmware implementation of the IPsec cryptography and the networking code will need to follow the guidelines in the preceding portion of this chapter. IPsec can be used for platform network boot to harden scenarios such as iSCSI-based provisioning.

Figure 10.16 shows the EFI IPsec implementation using the UEFI IPsec protocol and IPV6 network stack, including a pre-deployed security association (SA).

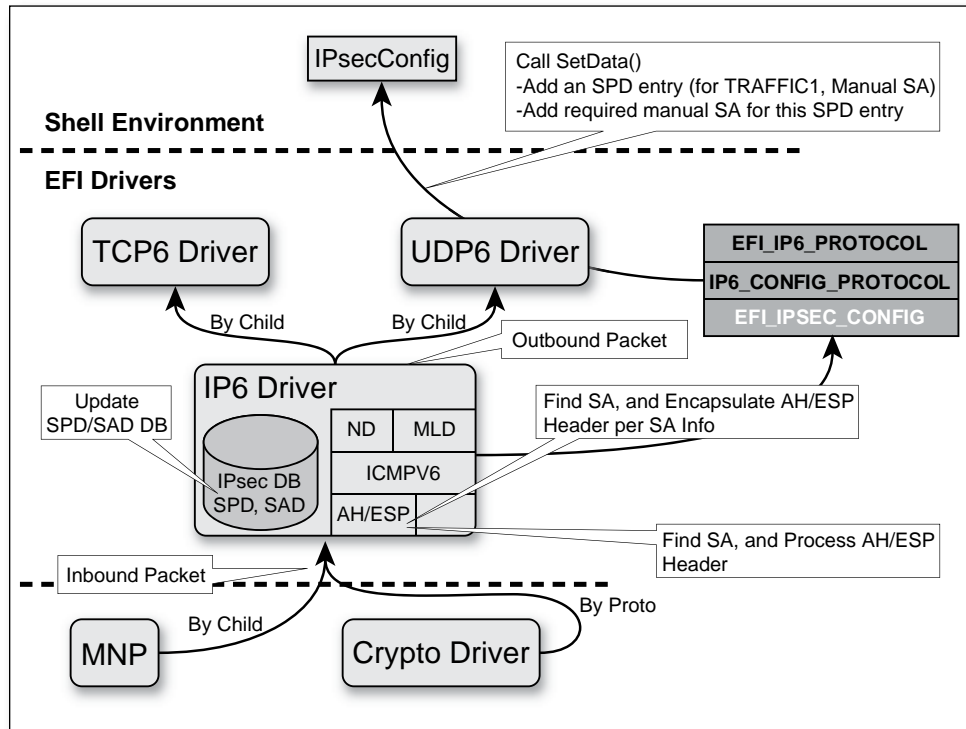

Figure 10.16 UEFI IPsec

IPsec in the platform will allow for performing both an IPV4 and IPV6-based iSCSI boot and provisioning. Figure 10.17 shows an iSCSI layering on top of the UEFI network stack, for example.

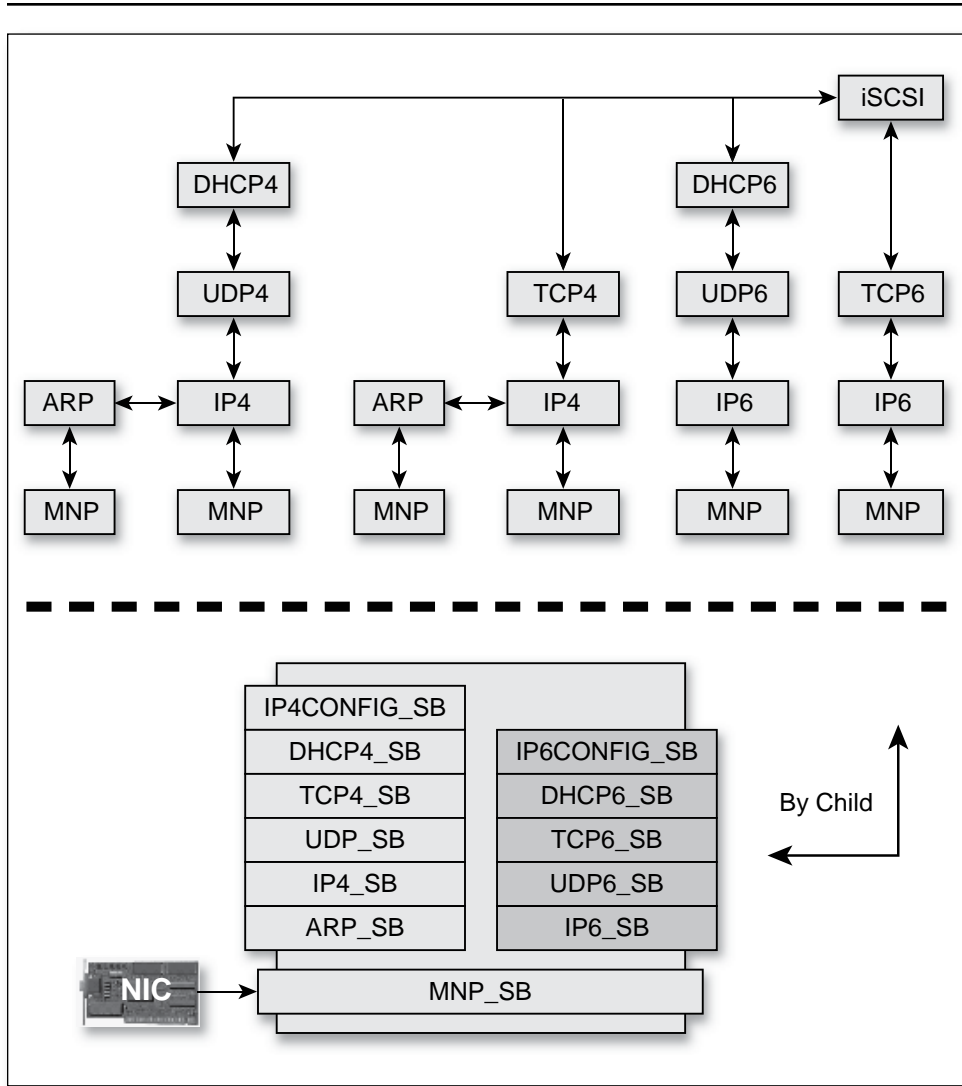

Figure 10.17 An iSCSI Application with UEFI Network Stack

Beyond the IP6 and IPsec UEFI interfaces, the wire-protocol for network booting has commensurate evolution to the UEFI APIs. Specifically, in the DHCPv6 extensions for IPV6 network booting, the boot file information is sent as a Uniform Resource Locator (URL); the network boot option details are described in both the UEFI 2.3 specification and in IETF Request For Comment (RFC) 5970. As such, the UEFI client machine and the boot server

can negotiate various types of downloads, including TFTP, FTP, HTTP, NFS, or iSCSI. This allows the network capabilities to track the needs of the market and the machine's firmware capabilities.

UEFI User Identification (UID)

A final ingredient in UEFI includes the user identity support. This is infrastructure that allows for loading drivers from token vendors to abstract authentication of the user, including many factors, and a policy engine to assign rights to certain users. This can include limiting service access for certain users. Figure 10.18 shows this capability.

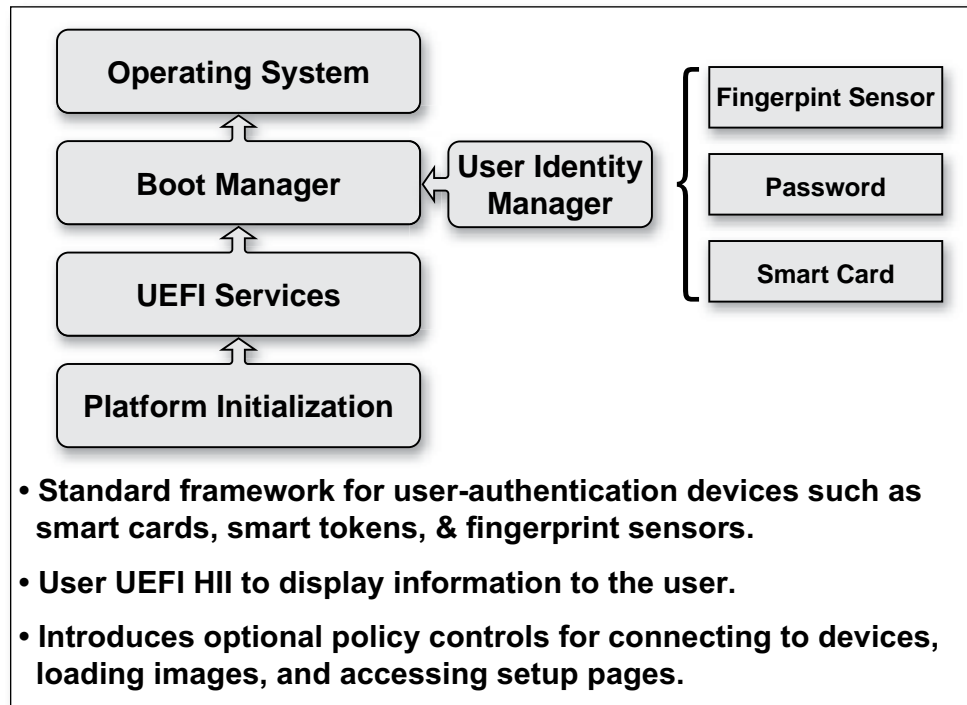
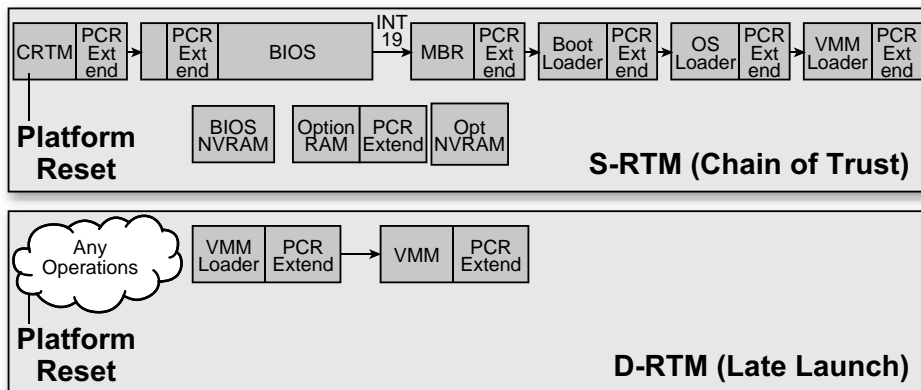

Figure 10.18 UEFI 2.3 User Identity

Implementation of these UEFI features would also build upon and require the assurance/best practices in firmware discussed earlier. More information on the UEFI-based features can be found in the UEFI main specification.

Hardware Evolution: SRTM-to-DRTM

As a final element getting introduced into the platform going forward is the dynamic root of trust for measurement, or D-RTM. The D-RTM provides platform hardware capabilities to support a measured launch environment (MLE). An S-RTM and D-RTM feature set can exist on the same platform, or each feature can exist independently. Figure 10.19 compares the two RTMs and their temporal evolution and features.



- **S-RTM measurement chain starts at reset and includes components from various sources.**
- **D-RTM measurement chain starts with a trusted secure event trigger such as SINIT. D-RTM leads to a smaller TCB, reduced attack surface and thus a more secure system.**
- **MLE provider must make assurances that the MLE maintains the TCB. Smaller TCB simplifies MLE design.**

Figure 10.19 DRTM Boot Flow

A DRTM implementation can also include a root-of-trust for verification (RTV), too. More information on Intel's D-RTM implementation can be found in the following book by David Grawrock, *Dynamics of a Trusted Platform* from Intel Press.

Platform Manufacturer

There are several terms that will be introduced in order to facilitate the following discussion. The first includes the entity that produces the final system board that includes the collection of UEFI and PI modules shown in Figure 10.20. This will be called the *platform manufacturer* or PM. The authority to perform updates or changes to the configuration of the UEFI and PI modules that ship from the factory are mediated by PM_AUTH or Platform Manufacturer Authority. PM_AUTH essentially describes the administrative roles that an entity who authenticates or proves itself to be the PM or delegate of the PM can perform. These actions can include but are not limited to the update of modules, firmware, or early PI settings. PM_AUTH typically is used to ensure the integrity of the PI and UEFI modules, and this integrity, or ensuring that the modules came from the manufacturer, can be accomplished via cryptographic updates of modules or signed UEFI capsules, for example.

As noted above, integrity forms one of the key security goals of the platform. If a third party can replace or impersonate a PI module without the PM's knowledge, there is an opportunity to introduce a vulnerability into the system.

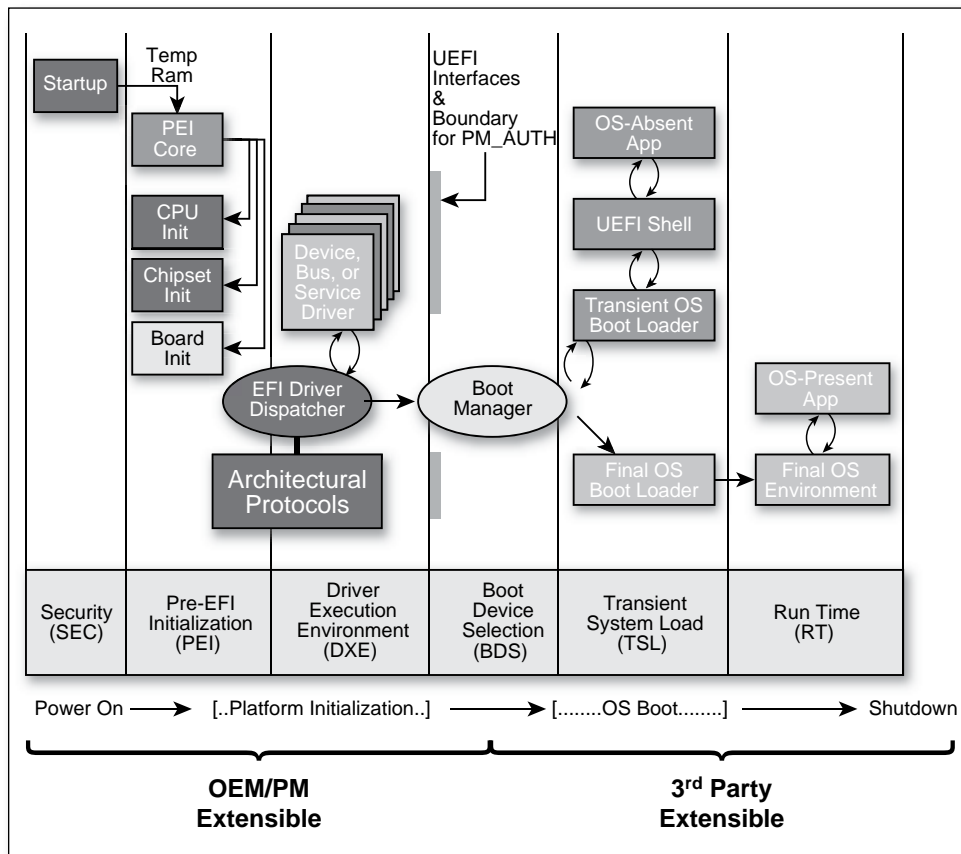

Figure 10.20 Overall View of Boot Time Line

When we refer to PM_AUTH, we mean “components that are under the authority of the Platform manufacturer.” This can include provenance of the PI code and data at rest (in the system board ROM container) and also the temporal state of the code in memory during system boot and runtime. The PM_AUTH can include the PEI and DXE driver dispatch responsive to an S5 restart, the SMM code running during the operating system runtime x64, and data at rest in the ROM after field updates.

The PM_AUTH really means that we do not have arbitrary third party extensibility. Arbitrary third party code could include an operating system loader deposited on the EFI System Partition during a post-ship OS install

or upgrade, or a PC/AT option ROM from a host bus adapter plugged into a system.

So for this model of integrity analysis, PM_AUTH = {SEC, PEI Core, PEIMs, DXE core, DXE drivers, firmware volumes, UEFI variables used only by PEI + DXE, BDS, PMI, SMM, UEFI runtime, ACPI tables, SMBIOS tables}.

Non-PM_AUTH is non-signed UEFI drivers from a host-bus adapter (HBA), non-signed UEFI OS loaders.

Vulnerability Classification

There are several terms that will be introduced in this section. These include spoofing, tampering, repudiation, information disclosure, denial of service, and elevation of privilege.

In order to talk about platform security, some terms will be introduced. Specifically, a vulnerability in a software or firmware product can subject the computer on which it is running to various attacks. Attacks may be grouped in the following categories:

- *Spoofing.* An attacker pretends that he is someone else, perhaps in order to inflict some damage on the person or organization impersonated.
- *Tampering.* An attacker is able to modify data or program behavior.
- *Repudiation.* An attacker, who has previously taken some action, is able to deny that he took it.
- *Information Disclosure.* An attacker is able to obtain access to information that he is not allowed to have.
- *Denial of Service.* An attacker prevents the system attacked from providing services to its legitimate users. The victim may become bogged down in fake workload, or even shut down completely.
- *Elevation of Privilege.* An attacker, who has entered the system at a low privilege level (such as a user), acquires higher privileges (such as those of an administrator).

Roots of Trust/Guards

When discussing integrity, a more formal model helps define some of the terms. A popular commercial integrity model includes that defined by Clark-Wilson (CW). In the CW model, there are controlled data items (CDIs) and uncontrolled data items (UDIs). The former must have some administrative control for changes, whereas the latter do not.

An example of a UDI can include a UEFI variable like the language code, whereas a CDI can include an authenticated variable such as the signature data base used for managing the x509V3 certificates. Figure 10.21 shows an example of a CDI, such as UEFI variables, and the Guard. Typically the caller would be a UEFI or OS application, the “request” would be the “set variable,” the Guard would be the UEFI implementation of the variable services, and the variable itself could include the `EFI_VARIABLE_AUTHENTICATED_WRITE_ACCESS` bit set.

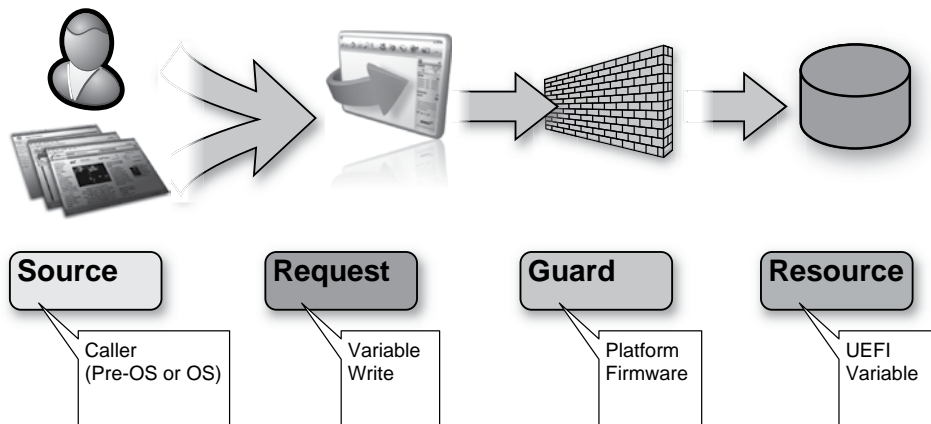

Figure 10.21 Flow of Actors in Access Control Model

Summary

This chapter has reviewed the static root of trust for measurement, or trusted boot, and the associated trusted computing hardware, including the TPM. It then described other preventive security technology, such as UEFI secure boot.

This chapter then described some background and guidance on how to prepare and integrate components that meet the platform assurance goals and also realize the purported capabilities of the security and trusted computing elements. This includes the concepts of trust and security. It also reviewed trusted computing technology, such as the Trusted Platform Module, SRTM, CRTM, and the TBB. Finally, the technology in the UEFI2.3 specification for security, such as driver signing, network authentication, and user identification was treated.

Chapter 11

Boot Device Selection

I just invent, then wait until man comes around to needing what I invented.

—R. Buckminster Fuller

UEFI has over time evolved a very basic paradigm for establishing a firmware policy engine. The concept was developed from the concept of a single boot manager whose sole purpose was exercising the policy established by some architecturally defined global NVRAM variables. As the firmware design evolved, and several distinct boot phases such as SEC, PEI, DXE, BDS, Runtime, and Afterlife were defined, the BDS (Boot Device Selection) phase became a distinct boot manager-like phase. In this chapter, the architectural components that steer the policy of the boot manager are reviewed. This content forms the architectural basis for what eventually became the BDS phase.

In fact, the differences between what is known as the boot manager in earlier firmware designs and what is known as the BDS in PI-based solutions is easy to illustrate. Figure 11.1 shows the software flow in an early firmware design environment, and Figure 11.2 shows one that is PI-compatible.

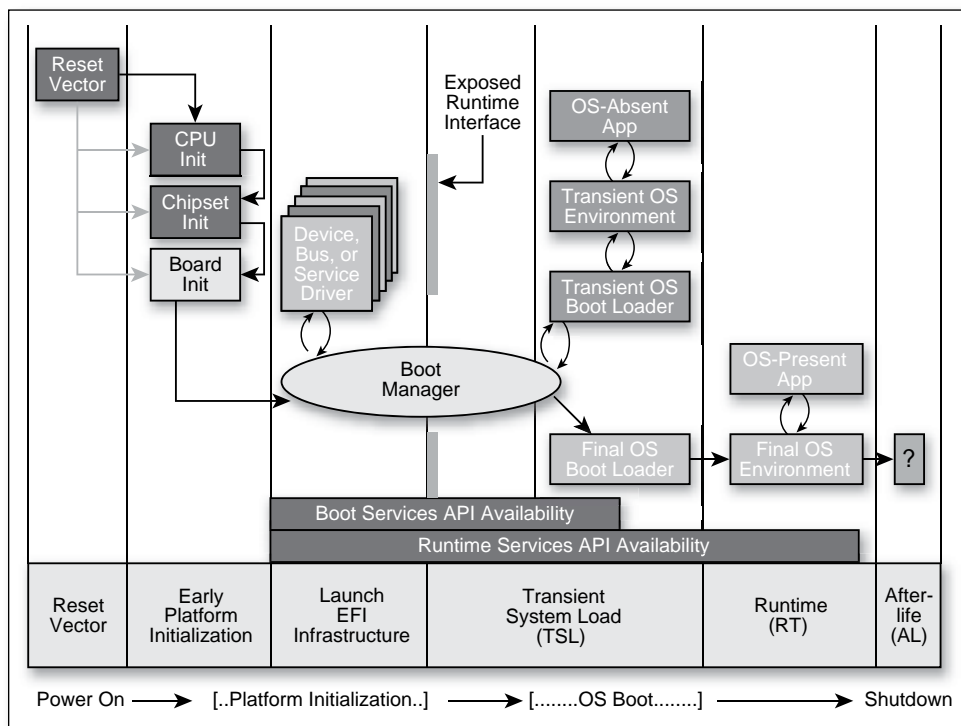

Figure 11.1 Earlier Firmware Designs with a Boot Manager Component

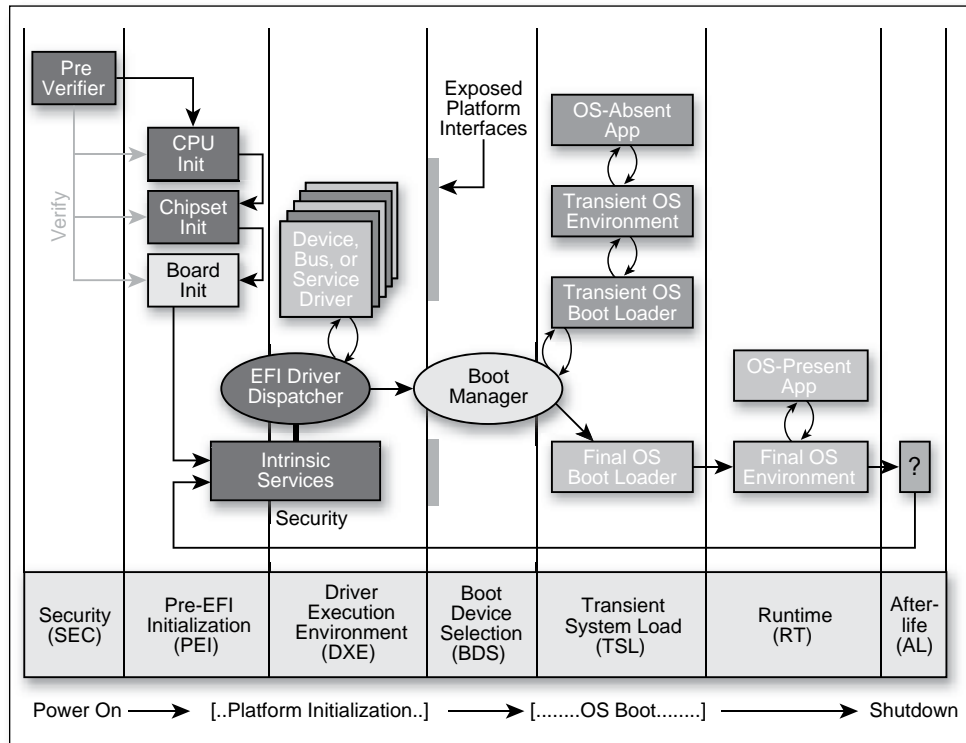

Figure 11.2 PI-based Solution with a BDS Component

As you can see from comparing the two figures, there is much overlap. The BDS phase subsumes the direction described in this chapter and is further explained in Chapter 8.

The UEFI boot manager is a firmware policy engine that can be configured by modifying architecturally defined global NVRAM variables. The boot manager attempts to load UEFI drivers and UEFI applications (including UEFI OS boot loaders) in an order defined by the global NVRAM variables. The platform firmware must use the boot order specified in the global NVRAM variables for normal boot. The platform firmware may add extra boot options or remove invalid boot options from the boot order list.

The platform firmware may also implement value-added features in the boot manager if an exceptional condition is discovered in the firmware boot process. One example of a value-added feature would be not loading a UEFI driver if booting failed the first time the driver was loaded. Another example

would be booting to an OEM-defined diagnostic environment if a critical error was discovered during the boot process.

The boot sequence for UEFI consists of the following:

- The platform firmware reads the boot order list from a globally defined NVRAM variable. The boot order list defines a list of NVRAM variables that contain information about what is to be booted. Each NVRAM variable defines a Unicode name for the boot option that can be displayed to a user.
- The variable also contains a pointer to the hardware device and to a file on that hardware device that contains the UEFI image to be loaded.
- The variable might also contain paths to the OS partition and directory along with other configuration-specific directories.

The NVRAM can also contain load options that are passed directly to the UEFI image. The platform firmware has no knowledge of what is contained in the load options. The load options are set by higher level software when it writes to a global NVRAM variable to set the platform firmware boot policy. This information could be used to define the location of the OS kernel if it was different than the location of the UEFI OS loader.

Firmware Boot Manager

The boot manager is a component in the UEFI firmware that determines which UEFI drivers and UEFI applications should be explicitly loaded and when. Once the UEFI firmware is initialized, it passes control to the boot manager. The boot manager is then responsible for determining what to load and any interactions with the user that may be required to make such a decision. Much of the behavior of the boot manager is left up to the firmware developer to decide, and details of boot manager implementation are outside the scope of this specification. In particular, likely implementation options might include any console interface concerning boot, integrated platform management of boot selections, possible knowledge of other internal applications or recovery drivers that may be integrated into the system through the boot manager.

Programmatic interaction with the boot manager is accomplished through globally defined variables. On initialization the boot manager reads the values

that comprise all of the published load options among the UEFI environment variables. By using the `SetVariable()` function the data that contain these environment variables can be modified.

Each load option entry resides in a `Boot####` variable or a `Driver####` variable where the `####` is replaced by a unique option number in printable hexadecimal representation using the digits 0–9, and the uppercase versions of the characters A–F (0000–FFFF). The `####` must always be four digits, so small numbers must use leading zeros. The load options are then logically ordered by an array of option numbers listed in the desired order. There are two such option ordering lists. The first is `DriverOrder` that orders the `Driver####` load option variables into their load order. The second is `BootOrder` that orders the `Boot####` load options variables into their load order.

For example, to add a new boot option, a new `Boot####` variable would be added. Then the option number of the new `Boot####` variable would be added to the `BootOrder` ordered list and the `BootOrder` variable would be rewritten. To change boot option on an existing `Boot####`, only the `Boot####` variable would need to be rewritten. A similar operation would be done to add, remove, or modify the driver load list.

If the boot via `Boot####` returns with a status of `EFI_SUCCESS` the boot manager stops processing the `BootOrder` variable and presents a boot manager menu to the user. If a boot via `Boot####` returns a status other than `EFI_SUCCESS`, the boot has failed and the next `Boot####` in the `BootOrder` variable will be tried until all possibilities are exhausted.

The boot manager may perform automatic maintenance of the database variables. For example, it may remove unreferenced load option variables, any unparseable or unloadable load option variables, and rewrite any ordered list to remove any load options that do not have corresponding load option variables. In addition, the boot manager may automatically update any ordered list to place any of its own load options where it desires. The boot manager can also, based on its platform-specific behavior, provide for manual maintenance operations as well. Examples include choosing the order of any or all load options, activating or deactivating load options, and so on.

The boot manager is required to process the `Driver` load option entries before the `Boot` load option entries. The boot manager is also required to initiate a boot of the boot option specified by the `BootNext` variable as

the first boot option on the next boot, and only on the next boot. The boot manager removes the `BootNext` variable before transferring control to the `BootNext` boot option. If the boot from the `BootNext` boot option fails the boot sequence continues utilizing the `BootOrder` variable. If the boot from the `BootNext` boot option succeeds by returning `EFI_SUCCESS` the boot manager will not continue to boot utilizing the `BootOrder` variable.

The boot manager must call `LoadImage()`, which supports at least `SIMPLE_FILE_PROTOCOL` and `LOAD_FILE_PROTOCOL` for resolving load options. If `LoadImage()` succeeds, the boot manager must enable the watchdog timer for 5 minutes by using the `SetWatchdogTimer()` boot service prior to calling `StartImage()`. If a boot option returns control to the boot manager, the boot manager must disable the watchdog timer with an additional call to the `SetWatchdogTimer()` boot service.

If the boot image is not loaded via `LoadImage()`, the boot manager is required to check for a default application to boot. Searching for a default application to boot happens on both removable and fixed media types. This search occurs when the device path of the boot image listed in any boot option points directly to a `SIMPLE_FILE_SYSTEM` device and does not specify the exact file to load. The file discovery method is explained in the section “Default Behavior for Boot Option Variables” later in this chapter. The default media boot case of a protocol other than `SIMPLE_FILE_SYSTEM` is handled by the `LOAD_FILE_PROTOCOL` for the target device path and does not need to be handled by the boot manager.

The boot manager must also support booting from a short-form device path that starts with the first element being a hard drive media device path. The boot manager must use the GUID or signature and partition number in the hard drive device path to match it to a device in the system. If the drive supports the GPT partitioning scheme the GUID in the hard drive media device path is compared with the `UniquePartitionGuid` field of the GUID Partition Entry. If the drive supports the PC-AT MBR scheme the signature in the hard drive media device path is compared with the `UniqueMBRSignature` in the Legacy Master Boot Record. If a signature match is made, then the partition number must also be matched. The hard drive device path can be appended to the matching hardware device path and normal boot behavior can then be used. If more than one device matches the hard drive device path, the boot manager picks one arbitrarily. Thus the operating system must ensure the uniqueness of the signatures on hard drives to guarantee deterministic boot behavior.

Each load option variable contains an `EFI_LOAD_OPTION` descriptor that is a byte-packed buffer of variable-length fields. Since some of the fields are of variable length, an `EFI_LOAD_OPTION` cannot be described as a standard C data structure. Instead, the fields are listed here in the order that they appear in an `EFI_LOAD_OPTION` descriptor:

```

UINT32           Attributes;
UINT16           FilePathListLength;
CHAR16           Description[];
EFI_DEVICE_PATH  FilePathList[];
UINT8           OptionalData[];

```

- *Attributes* – The attributes for this load option entry. All unused bits must be zero and are reserved by the UEFI specification for future growth. See “Related Definitions.”
- *FilePathListLength* – Length in bytes of the `FilePathList`. `OptionalData` starts at `offset sizeof(UINT32) + sizeof(UINT16) + StrSize(Description) + FilePathListLength` of the `EFI_LOAD_OPTION` descriptor.
- *Description* – The user readable description for the load option. This field ends with a Null Unicode character.
- *FilePathList* – A packed array of UEFI device paths. The first element of the array is a UEFI device path that describes the device and location of the Image for this load option. The `FilePathList[0]` is specific to the device type. Other device paths may optionally exist in the `FilePathList`, but their usage is OSV specific. Each element in the array is variable length, and ends at the device path end structure. Because the size of `Description` is arbitrary, this data structure is not guaranteed to be aligned on a natural boundary. This data structure may have to be copied to an aligned natural boundary before it is used.
- *OptionalData* – The remaining bytes in the load option descriptor are a binary data buffer that is passed to the loaded image. If the field is zero bytes long, a Null pointer is passed to the loaded image. The

number of bytes in `OptionalData` can be computed by subtracting the starting offset of `OptionalData` from total size in bytes of the `EFI_LOAD_OPTION`.

Related Definitions

The load option attributes are defined by the values below.

```
//
// Attributes
//
#define LOAD_OPTION_ACTIVE          0x00000001
#define LOAD_OPTION_FORCE_RECONNECT 0x00000002
```

Calling `SetVariable()` creates a load option. The size of the load option is the same as the size of the `DataSize` argument to the `SetVariable()` call that created the variable. When creating a new load option, all undefined attribute bits must be written as zero. When updating a load option, all undefined attribute bits must be preserved. If a load option is not marked as `LOAD_OPTION_ACTIVE`, the boot manager will not automatically load the option. This provides an easy way to disable or enable load options without needing to delete and reload them. If any `Driver###` load option is marked as `LOAD_OPTION_FORCE_RECONNECT`, then all of the UEFI drivers in the system will be disconnected and reconnected after the last `Driver###` load option is processed. This allows a UEFI driver loaded with a `Driver###` load option to override a UEFI driver that was loaded prior to the execution of the UEFI Boot Manager.

Globally-Defined Variables

This section defines a set of variables that have architecturally defined meanings. In addition to the defined data content, each such variable has an architecturally defined attribute that indicates when the data variable may be accessed. The variables with an attribute of `NV` are nonvolatile. This means that their values are persistent across resets and power cycles. The value of any environment variable that does not have this attribute will be lost when power is removed from the system and the state of firmware reserved memory is not otherwise preserved. The variables with an attribute of `BS` are only available before

`ExitBootServices()` is called. This means that these environment variables can only be retrieved or modified in the preboot environment. They are not visible to an operating system. Environment variables with an attribute of RT are available before and after `ExitBootServices()` is called. Environment variables of this type can be retrieved and modified in the preboot environment, and from an operating system. All architecturally defined variables use the `EFI_GLOBAL_VARIABLE` VendorGuid:

```
#define EFI_GLOBAL_VARIABLE \
    {8BE4DF61-93CA-11d2-AA0D-00E098032B8C}
```

To prevent name collisions with possible future globally defined variables, other internal firmware data variables that are not defined here must be saved with a unique VendorGuid other than `EFI_GLOBAL_VARIABLE`. Table 11.1 lists the global variables.

Table 11.1 Global Variables

Variable Name	Attribute	Description
<code>LangCodes</code>	BS, RT	The language codes that the firmware supports.
<code>Lang</code>	NV, BS, RT	The language code that the system is configured for.
<code>Timeout</code>	NV, BS, RT	The firmware's boot managers timeout, in seconds, before initiating the default boot selection.
<code>ConIn</code>	NV, BS, RT	The device path of the default input console.
<code>ConOut</code>	NV, BS, RT	The device path of the default output console.
<code>ErrOut</code>	NV, BS, RT	The device path of the default error output device.
<code>ConInDev</code>	BS, RT	The device path of all possible console input devices.
<code>ConOutDev</code>	BS, RT	The device path of all possible console output devices.
<code>ErrOutDev</code>	BS, RT	The device path of all possible error output devices.
<code>Boot####</code>	NV, BS, RT	A boot load option, where #### is a printed hex value. No 0x or h is included in the hex value.
<code>BootOrder</code>	NV, BS, RT	The ordered boot option load list.
<code>BootNext</code>	NV, BS, RT	The boot option for the next boot only.
<code>BootCurrent</code>	BS, RT	The boot option that was selected for the current boot.
<code>Driver####</code>	NV, BS, RT	A driver load option, where #### is a printed hex value.
<code>DriverOrder</code>	NV, BS, RT	The ordered driver load option list.

The `LangCodes` variable contains an array of 3-character (8-bit ASCII characters) ISO-639-2 language codes that the firmware can support. At initialization time the firmware computes the supported languages and creates this data variable. Since the firmware creates this value on each initialization, its contents are not stored in nonvolatile memory. This value is considered read-only.

The `Lang` variable contains the 3-character (8-bit ASCII characters) ISO-639-2 language code for which the machine has been configured. This value may be changed to any value supported by `LangCodes`; however, the change does not take effect until the next boot. If the language code is set to an unsupported value, the firmware chooses a supported default at initialization and sets `Lang` to a supported value.

The `Timeout` variable contains a binary `UINT16` (unsigned 16 bit value) that supplies the number of seconds that the firmware waits before initiating the original default boot selection. A value of 0 indicates that the default boot selection is to be initiated immediately on boot. If the value is not present, or contains the value of `0xFFFF`, then firmware waits for user input before booting. This means the default boot selection is not automatically started by the firmware.

The `ConIn`, `ConOut`, and `ErrOut` variables each contain an `EFI_DEVICE_PATH` descriptor that defines the default device to use on boot. Changes to these values do not take effect until the next boot. If the firmware cannot resolve the device path, it is allowed to automatically replace the value(s) as needed to provide a console for the system.

The `ConInDev`, `ConOutDev`, and `ErrOutDev` variables each contain an `EFI_DEVICE_PATH` descriptor that defines all the possible default devices to use on boot. These variables are volatile, and are set dynamically on every boot. `ConIn`, `ConOut`, and `ErrOut` are always proper subsets of `ConInDev`, `ConOutDev`, and `ErrOutDev`.

Each `Boot####` variable contains an `EFI_LOAD_OPTION`. Each `Boot####` variable is the name “Boot” appended with a unique four digit hexadecimal number. For example, `Boot0001`, `Boot0002`, `Boot0A02`, and so on.

The `BootOrder` variable contains an array of `UINT16`s that make up an ordered list of the `Boot####` options. The first element in the array is the value for the first logical boot option, the second element is the value for the

second logical boot option, and so on. The `BootOrder` order list is used by the firmware's boot manager as the default boot order.

The `BootNext` variable is a single `UINT16` that defines the `Boot####` option that is to be tried first on the next boot. After the `BootNext` boot option is tried the normal `BootOrder` list is used. To prevent loops, the boot manager deletes this variable before transferring control to the preselected boot option.

The `BootCurrent` variable is a single `UINT16` that defines the `Boot####` option that was selected on the current boot.

Each `Driver####` variable contains an `EFI_LOAD_OPTION`. Each load option variable is appended with a unique number, for example `Driver0001`, `Driver0002`, and so on.

The `DriverOrder` variable contains an array of unsigned 16 bit values that make up an ordered list of the `Driver####` variable. The first element in the array is the value for the first logical driver load option, the second element is the value for the second logical driver load option, and so on. The `DriverOrder` list is used by the firmware's boot manager as the default load order for UEFI drivers that it should explicitly load.

Default Behavior for Boot Option Variables

The default state of globally defined variables is firmware vendor specific. However the boot options require a standard default behavior in the exceptional case that valid boot options are not present on a platform. The default behavior must be invoked any time the `BootOrder` variable does not exist or only points to nonexistent boot options.

If no valid boot options exist, the boot manager enumerates all removable UEFI media devices followed by all fixed UEFI media devices. The order within each group is undefined. These new default boot options are not saved to nonvolatile storage. The boot manger then attempts to boot from each boot option. If the device supports the `SIMPLE_FILE_SYSTEM` protocol then the removable media boot behavior (see the section “Removable Media Boot Behavior”) is executed. Otherwise the firmware attempts to boot the device via the `LOAD_FILE` protocol.

It is expected that this default boot will load an operating system or a maintenance utility. If this is an operating system setup program it is then responsible for setting the requisite environment variables for subsequent

boots. The platform firmware may also decide to recover or set to a known set of boot options.

Boot Mechanisms

UEFI can boot from a device using the `SIMPLE_FILE_SYSTEM` protocol or the `LOAD_FILE` protocol. A device that supports the `SIMPLE_FILE_SYSTEM` protocol must materialize a file system protocol for that device to be bootable. If a device does not support a complete file system it may produce a `LOAD_FILE` protocol that allows it to create an image directly. The boot manager will attempt to boot using the `SIMPLE_FILE_SYSTEM` protocol first. If that fails, then the `LOAD_FILE` protocol will be used.

Boot via Simple File Protocol

When booting via the `SIMPLE_FILE_SYSTEM` protocol, the `FilePath` parameter will start with a device path that points to the device that “speaks” the `SIMPLE_FILE_SYSTEM` protocol. The next part of the `FilePath` will point to the file name, including subdirectories that contain the bootable image. If the file name is a null device path, the file name must be discovered on the media using the rules defined for removable media devices with ambiguous file names (see the section “Removable Media Boot Behavior”).

The format of the file system specified by UEFI is contained in the UEFI specification. While the firmware must produce a `SIMPLE_FILE_SYSTEM` protocol that understands the UEFI file system, any file system can be abstracted with the `SIMPLE_FILE_SYSTEM` protocol interface.

Removable Media Boot Behavior

On a removable media device it is not possible for the `FilePath` to contain a file name, including subdirectories. The `FilePath` is stored in nonvolatile memory in the platform and cannot possibly be kept in sync with a media that can change at any time. A `FilePath` for a removable media device will point to a device that “speaks” the `SIMPLE_FILE_SYSTEM` protocol. The `FilePath` will not contain a file name or subdirectories.

The system firmware will attempt to boot from a removable media `FilePath` by adding a default file name in the form `\EFI\BOOT\BOOT{machine type short-name}.EFI`. Where *machine type short-name* defines a PE32+ image

format architecture. Each file only contains one UEFI image type, and a system may support booting from one or more images types. Table 11.2 lists the UEFI image types.

Table 11.2 UEFI Image Types

Architecture	File name convention	PE Executable machine type*
IA-32	BOOTIA32.EFI	0x14c
x64	BOOTx64.EFI	0x8664
Itanium® architecture	BOOTIA64.EFI	0x200
ARM† architecture	BOOTARM.EFI	0x01c2

*Note: The PE Executable machine type is contained in the machine field of the COFF file header as defined in the Microsoft Portable Executable and Common Object File Format Specification, Revision 6.0.

A media may support multiple architectures by simply having a `\EFI\BOOT\BOOT{machine type short-name}.EFI` file of each possible machine type.

Non-removable Media Boot Behavior

On a non-removable media device it is possible for the FilePath to contain a file name, including subdirectories. The FilePath will be used for the boot target and the platform will launch the target according to normal system policy.

The platform policy will leverage the `BOOT####` variables referenced by the `BootOrder` variable in the system. These `BOOT####` variables are the ones which contain the FilePath data for the boot target and are what typically are used for the boot process to occur.

Boot via LOAD_FILE Protocol

When booting via the `LOAD_FILE` protocol, the FilePath is a device path that points to a device that “speaks” the `LOAD_FILE` protocol. The image is loaded directly from the device that supports the `LOAD_FILE` protocol. The remainder of the FilePath contains information that is specific to the device. UEFI firmware passes this device-specific data to the loaded image, but does not use it to load the image. If the remainder of the FilePath is a null device

path it is the loaded image's responsibility to implement a policy to find the correct boot device.

The `LOAD_FILE` protocol is used for devices that do not directly support file systems. Network devices commonly boot in this model where the image is materialized without the need of a file system.

Network Booting

Network booting is described by the Preboot eXecution Environment (PXE) BIOS Support Specification that is part of the Wired for Management Baseline specification. PXE specifies UDP, DHCP, and TFTP network protocols that a booting platform can use to interact with an intelligent system load server. UEFI defines special interfaces that are used to implement PXE. These interfaces are contained in the `PXE_BASE_CODE` protocol defined in the UEFI specification.

Future Boot Media

Since UEFI defines an abstraction between the platform and the operating system and its loader it should be possible to add new types of boot media as technology evolves. The OS loader will not necessarily have to change to support new types of boot. The implementation of the UEFI platform services may change, but the interface will remain constant. The operating system will require a driver to support the new type of boot media so that it can make the transition from UEFI boot services to operating system control of the boot media.

Summary

In conclusion, this chapter indicates the mechanism by which a UEFI compliant system determines what the boot target(s) is and in what order such execution would occur. This methodology also provides a cooperative mechanism that is highly extensible and that third parties (such as an OS vendor) can use for their own installation and execution.

Chapter 12

Boot Flows

Two roads diverged in a wood....

—Robert Frost, “The Road Less Taken”

The restart of a system admits to many possibilities, or paths of execution. The restart of a CPU execution for a given CPU can have many causes and different environment states that impinge upon it. These can include requests to the firmware for an update of the flash store, resumption of a power management event, initial startup of the system, and other possible restarts. This chapter describes some of these possible flows and how the UEFI PI handles the events.

To begin, the normal code flow in the UEFI PI passes through a succession of phases, in the following order:

1. SEC
2. PEI
3. DXE
4. BDS
5. Runtime
6. Afterlife

This chapter describes alternatives to this ordering, which can also be seen in Figure 12.1.

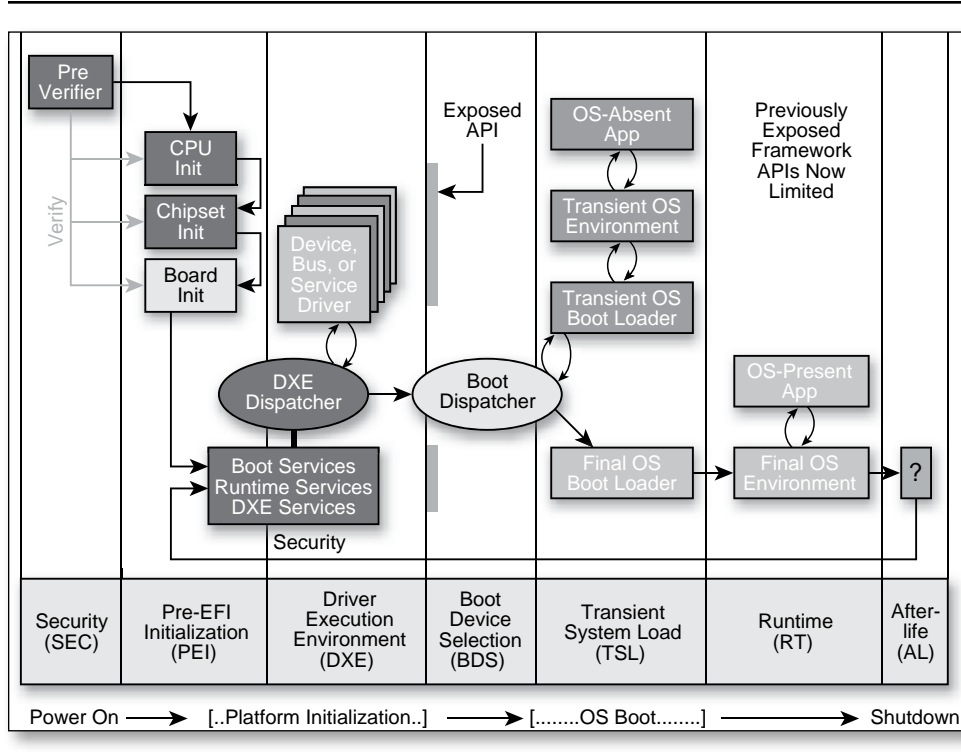

Figure 12.1 Ordering of UEFI PI Execution Phases

The PEI Foundation is unaware of the boot path required by the system. It relies on the PEIMs to determine the boot mode and to take appropriate action depending on the mode. To implement this determination of the boot mode, each PEIM has the ability to manipulate the boot mode using the PEI Service `SetBootMode()` described in the discussion of PEI in Chapter 13. Note that the PEIM does not change the order in which PEIMs are dispatched depending on the boot mode.

Defined Boot Modes

The list of possible boot modes and their corresponding priorities is shown in the following section. UEFI PI architecture avoids defining an upgrade path specifically, should new boot modes need be defined. This is necessary as the nature of those additional boot modes may work in conjunction with or may conflict with the previously defined boot modes.

Priority of Boot Paths

Within a given PEIM, a priority of the boot modes must be observed, as shown in Figure 12.2. The priority ordering of the sources of boot mode should be as follows (from highest priority to lowest):

1. `BOOT_IN_RECOVERY_MODE`
2. `BOOT_ON_FLASH_UPDATE`
3. `BOOT_ON_S3_RESUME`
4. `BOOT_WITH_MINIMAL_CONFIGURATION`
5. `BOOT_WITH_FULL_CONFIGURATION`
6. `BOOT_ASSUMING_NO_CONFIGURATION_CHANGES`
7. `BOOT_WITH_FULL_CONFIGURATION_PLUS_`
`DIAGNOSTICS`
8. `BOOT_WITH_DEFAULT_SETTINGS`
9. `BOOT_ON_S4_RESUME`
10. `BOOT_ON_S5_RESUME`
11. `BOOT_ON_S2_RESUME`

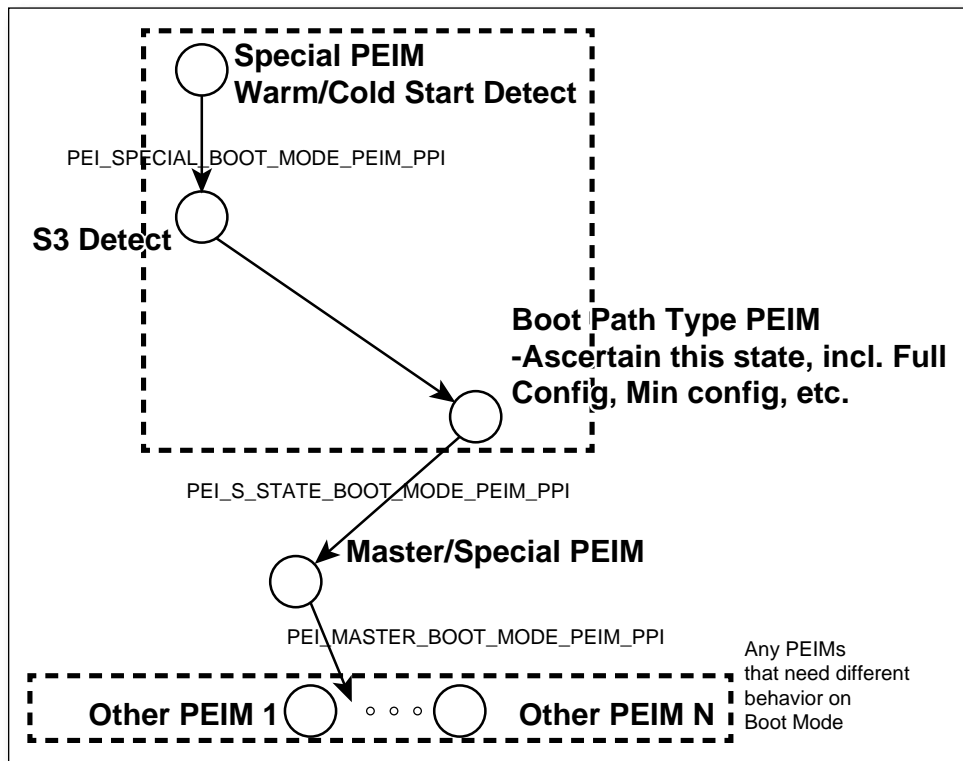

Figure 12.2 Priority of the Boot Modes

Table 12.1 lists the assumptions that can and cannot be made about the system for each sleep state.

Table 12.1 Boot Path Assumptions

System State	Description	Assumptions
R0	Cold Boot	Cannot assume that the previously stored configuration data is valid.
R1	Warm Boot	May assume that the previously stored configuration data is valid.

S3	ACPI Save to RAM Resume	The previously stored configuration data is valid and RAM is valid. RAM configuration must be restored from nonvolatile storage (NVS) before RAM may be used. The firmware may only modify previously reserved RAM. There are two types of reserved memory. One is the equivalent of the BIOS INT15h, E820 type-4 memory and indicates that the RAM is reserved for use by the firmware. The suggestion is to add another type of memory that allows the OS to corrupt the memory during runtime but that may be overwritten during resume.
S4, S5	Save to Disk Resume, "Soft Off"	S4 and S5 are identical from a PEIM's point of view. The two are distinguished to support follow-on phases. The entire system must be reinitialized but the PEIMs may assume that the previous configuration is still valid.
Boot on Flash Update		This boot mode can be either an INIT, S3, or other means by which to restart the machine. If it is an S3, for example, the flash update cause will supersede the S3 restart. It is incumbent upon platform code, such as the Memory Initialization PEIM, to determine the exact cause and perform correct behavior (that is, S3 state restoration versus INIT behavior).

Reset Boot Paths

The following sections describe the boot paths that are followed when a system encounters several different types of reset.

Intel® Itanium® Processor Reset

Intel® Itanium® architecture contains enough hooks to authenticate PAL-A and PAL-B code that is distributed by the processor vendor. The internal microcode on the processor silicon, which starts up on a PowerGood reset, finds the first layer of processor abstraction code (called PAL-A) that is located in the Boot Firmware Volume (BFV) using architecturally defined pointers in the BFV. It is the responsibility of this microcode to authenticate that the PAL-A code layer from the processor vendor has not been tampered with. If the authentication of the PAL-A layer passes, control then passes to the PAL-A layer, which then authenticates the next layer of processor abstraction code (called PAL-B) before passing control to it. In addition to this microarchitecture-specific

authentication, the SEC phase of UEFI PI is still responsible for locating the PEI Foundation and verifying its authenticity.

In an Itanium-based system, it is also imperative that the firmware modules in the BFV be organized such that at least the PAL-A is contained in the fault-tolerant regions. This processor-specific PAL-A authenticates the PAL-B code, which is usually contained in the regions of the firmware system that do not support fault-tolerant updates. The PAL-A and PAL-B binary components are always visible to all the processors in a node at the time of power-on; the system fabric should not need to be initialized.

Non-Power-on Resets

Non-power-on resets can occur for many reasons. Some PEI and DXE system services reset and reboot the entire platform, including all processors and devices. It is important to have a standard variant of this boot path for cases such as the following:

- Resetting the processor to change frequency settings
- Restarting hardware to complete chipset initialization
- Responding to an exception from a catastrophic error

This reset is also used for Configuration Values Driven through Reset (CVDR) configuration.

Normal Boot Paths

A traditional BIOS executes POST from a cold boot (G3 to S0 state), on resumes, or in special cases like INIT. UEFI covers all those cases but provides a richer and more standardized operating environment.

The basic code flow of the system needs to be changeable due to different circumstances. The boot path variable satisfies this need. The initial value of the boot mode is defined by some early PEIMs, but it can be altered by other, later PEIMs. All systems must support a basic S0 boot path. Typically a system has a richer set of boot paths, including S0 variations, S-state boot paths, and one or more special boot paths.

The architecture for multiple boot paths presented here has several benefits:

- The PEI Foundation is not required to be aware of system-specific requirements such as multi-processor capability and various power states. This lack of awareness allows for scalability and headroom for future expansion.
- Supporting the various paths only minimally impacts the size of the PEI Foundation.
- The PEIMs required to support the paths scale with the complexity of the system.

Note that the Boot Mode Register becomes a variable upon transition to the DXE phase. The DXE phase can have additional modifiers that affect the boot path more than the PEI phase. These additional modifiers can indicate if the system is in manufacturing mode, chassis intrusion, or AC power loss or if silent boot is enabled.

In addition to the boot path types, modifier bits might be present. The recovery-needed modifier is set if any PEIM detects that it has become corrupted.

Basic G0-to-S0 and S0 Variation Boot Paths

The basic S0 boot path is *boot with full configuration*. This path setting informs all PEIMs to do a full configuration. The basic S0 boot path must be supported.

The UEFI PI architecture also defines several optional variations to the basic S0 boot path. The variations that are supported depend on the following:

- Richness of supported features
- If the platform is open or closed
- Platform hardware

For example, a closed system or one that has detected a chassis intrusion could support a boot path that assumes no configuration changes from last boot option, thus allowing a very rapid boot time. Unsupported variations default to basic S0 operation. The following are the defined variations to the basic boot path:

- *Boot with minimal configuration:* This path is for configuring the minimal amount of hardware to boot the system.
- *Boot assuming no configuration changes:* This path uses the last configuration data.
- *Boot with full configuration plus diagnostics:* This path also causes any diagnostics to be executed.
- *Boot with default settings:* This path uses a known set of safe values for programming hardware.

S-State Boot Paths

The following optional boot paths allow for different operation for a resume from S3, S4, and S5:

- *S3 (Save to RAM Resume):* Platforms that support S3 resume must take special care to preserve/restore memory and critical hardware.
- *S4 (Save to Disk):* Some platforms may want to perform an abbreviated PEI and DXE phase on a S4 resume.
- *S5 (Soft Off):* Some platforms may want an S5 system state boot to be differentiated from a normal boot—for example, if buttons other than the power button can wake the system.

An S3 resume needs to be explained in more detail because it requires cooperation between a G0-to-S0 boot path and an S3 resume boot path. The G0-to-S0 boot path needs to save hardware programming information that the S3 resume path needs to retrieve. This information is saved in the Hardware Save Table using predefined data structures to perform I/O or memory writes. The data is stored in a UEFI equivalent of the INT15 E820 type 4 (firmware reserved memory) area or a firmware device area that is reserved for use by UEFI. The S3 resume boot path code can access this region after memory has been restored.

Recovery Paths

All of the previously described boot paths can be modified or aborted if the system detects that recovery is needed. Recovery is the process of reconstituting a system's firmware devices when they have become corrupted. The corruption can be caused by various mechanisms. Most firmware volumes on nonvolatile storage devices (flash, disk) are managed as blocks. If the system loses power while a block, or semantically bound blocks, are being updated, the storage might become invalid. On the other hand, the device might become corrupted by an errant program or by errant hardware. The system designers must determine the level of support for recovery based on their perceptions of the probabilities of these events occurring and their consequences.

The following are some reasons why system designers may choose not to support recovery:

- A system's firmware volume storage media might not support modification after being manufactured. It might be the functional equivalent of ROM.
- Most mechanisms of implementing recovery require additional firmware volume space, which might be too expensive for a particular application.
- A system may have enough firmware volume space and hardware features that the firmware volume can be made sufficiently fault tolerant to make recovery unnecessary.

Discovery

Discovering that recovery is required may be done using a PEIM (for example, by checking a "force recovery" jumper) or the PEI Foundation itself. The PEI Foundation might discover that a particular PEIM has not validated correctly or that an entire firmware has become corrupted.

General Recovery Architecture

The concept behind recovery is to preserve enough of the system firmware so that the system can boot to a point where it can do the following:

- Read a copy of the data that was lost from chosen peripherals.
- Reprogram the firmware volume with that data.

Preserving the recovery firmware is a function of the way the firmware volume store is managed, which is generally beyond the scope of this book. For the purpose of this description, it is expected that the PEIMs and other contents of the firmware volumes required for recovery are marked. The architecture of the firmware volume store must then preserve marked items, either by making them unalterable (possibly with hardware support) or must protect them using a fault-tolerant update process. Note that a PEIM is required to be in a fault-tolerant area if it indicates it is required for recovery or if a PEIM required for recovery depends on it. This architecture also assumes that it is fairly easy to determine that firmware volumes have become corrupted.

The PEI Dispatcher then proceeds as normal. If it encounters PEIMs that have been corrupted (for example, by receiving an incorrect hash value), it itself must change the boot mode to recovery. Once set to recovery, other PEIMs must not change it to one of the other states. After the PEI Dispatcher has discovered that the system is in recovery mode, it will restart itself, dispatching only those PEIMs that are required for recovery. A PEIM can also detect a catastrophic condition or a forced-recovery event and inform the PEI Dispatcher that it needs to proceed with a recovery dispatch. A PEIM can alert the PEI Foundation to start recovery by OR ing the `BOOT_IN_RECOVERY_MODE_MASK` bit onto the present boot mode. The PEI Foundation then resets the boot mode to `BOOT_IN_RECOVERY_MODE` and starts the dispatch from the beginning with `BOOT_IN_RECOVERY_MODE` as the sole value for the mode.

It is possible that a PEIM could be built to handle the portion of the recovery that would initialize the recovery peripherals (and the buses they reside on) and then to read the new images from the peripherals and update the firmware volumes.

It is considered far more likely that the PEI will transition to DXE because DXE is designed to handle access to peripherals. This transition has the additional benefit that, if DXE then discovers that a device has become corrupted, it may institute recovery without transferring control back to the PEI.

If the PEI Foundation does not have a list of what it is to dispatch, how does it know whether an area of invalid space in a firmware volume should

have contained a PEIM or not? It seems that the PEI Foundation may discover most corruption as an incidental result of its search for PEIMs. In this case, if the PEI Foundation completes its dispatch process without discovering enough static system memory to start DXE, then it should go into recovery mode.

Special Boot Path Topics

The remaining sections in this chapter discuss special boot paths that might be available to all processors or specific considerations that apply only for Intel Itanium processors.

Special Boot Paths

The following are special boot paths in the UEFI PI architecture. Some of these paths are optional and others are processor-family specific.

- *Forced recovery boot:* A jumper or an equivalent mechanism indicates a forced recovery.
- *Intel Itanium architecture boot paths:* See the next section.
- *Capsule update:* This boot mode can be an INIT, S3, or some other means by which to restart the machine. If it is an S3, for example, the capsule cause will supersede the S3 restart. It is incumbent upon platform code, such as a memory initialization PEIM, to determine the exact cause and perform the correct behavior—that is, S3 state restoration versus INIT behavior.

Special Intel Itanium® Architecture Boot Paths

The architecture requires the following special boot paths:

- *Boot after INIT:* An INIT has occurred.
- *Boot after MCA:* A Machine Check Architecture (MCA) event has occurred.

Intel Itanium processors possess several unique boot paths that also invoke the dispatcher located at the System Abstraction Layer entry point SALE_ENTRY.

The processor INIT and MCA are two asynchronous events that start up the SEC code/dispatcher in an Itanium-based system. The UEFI PI security module is transparent during all the code paths except for the recovery check call that happens during a cold boot. The PEIMs or DXE drivers that handle these events are architecture-aware and do not return the control to the core dispatcher. They call their respective architectural handlers in the OS.

Intel Itanium® Architecture Access to the Boot Firmware Volume

Figure 12.3 shows the reset boot path that an Intel Itanium processor follows. Figure 12.4 shows the boot flow.

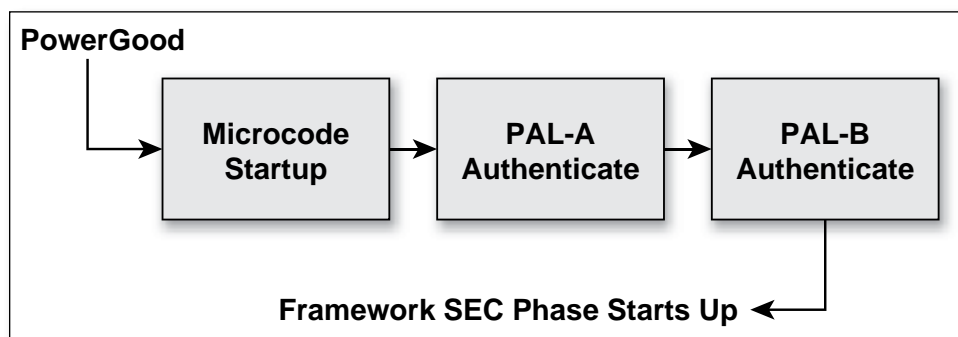

Figure 12.3 Intel® Itanium® Architecture Resets

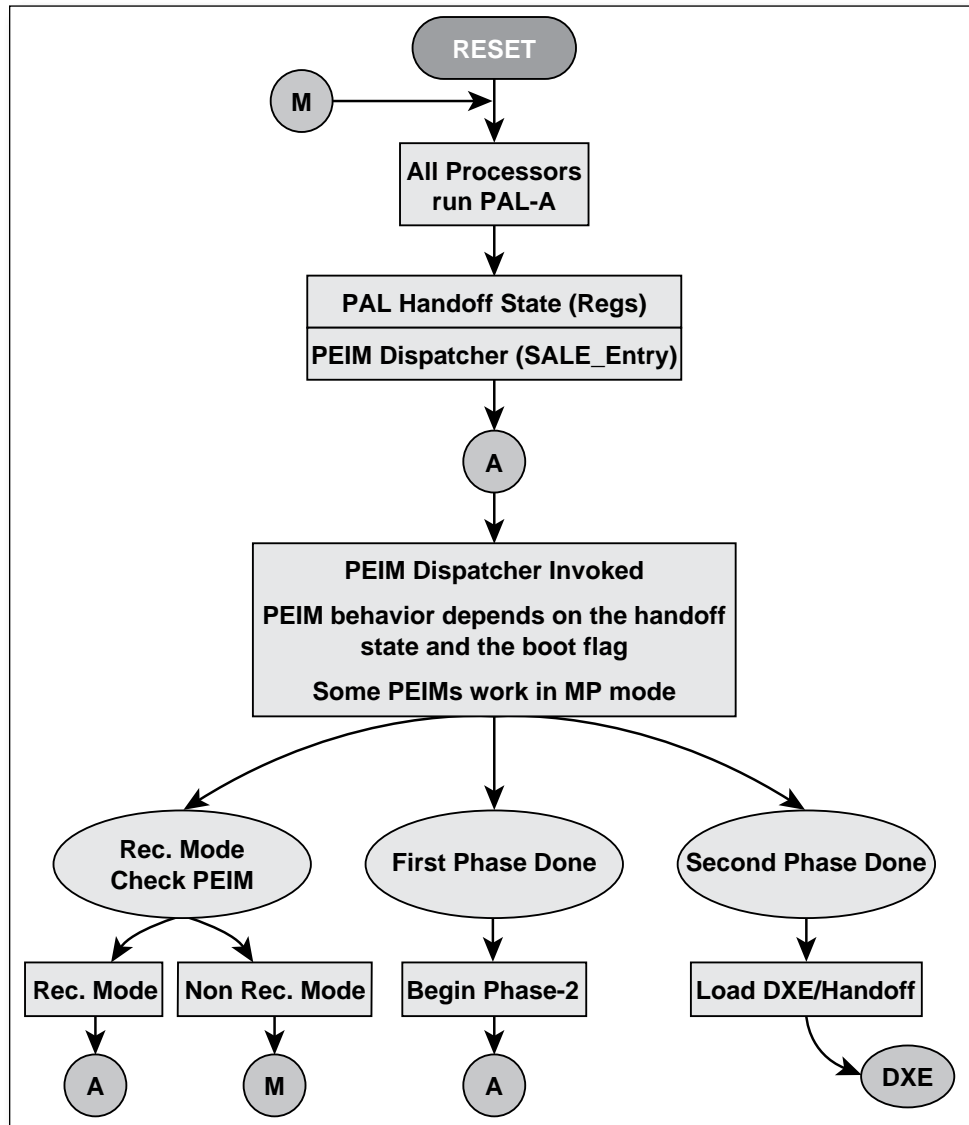

Figure 12.4 Intel® Itanium® Processor Boot Flow (MP versus UP on Other CPUs)

In Intel Itanium architecture, the microcode starts up the first layer of the PAL code, provided by the processor vendor, that resides in the Boot Firmware Volume (BFV). This code minimally initializes the processor and then finds and authenticates the second layer of PAL code (called PAL-B). The location of both PAL-A and PAL-B can be found by consulting either the architected pointers in the ROM near the 4-gigabyte region or by consulting the Firmware Interface Table (FIT) pointer in the ROM. The PAL layer communicates with the OEM boot firmware using a single entry point called `SALE_ENTRY`.

The Intel Itanium architecture defines the initialization described above. In addition, however, Itanium-based systems that use the UEFI PI architecture must do the following:

- *A “special” PEIM must be resident in the BFV to provide information about the location of the other firmware volumes.*

The PEI Foundation will be located at the `SALE_ENTRY` point on the BFV. The Intel Itanium architecture PEIMs may reside in the BFV or other firmware volumes, but a special PEIM must be resident in the BFV to provide information about the location of the other firmware volumes.

- *The BFV of a particular node must be accessible by all the processors running in that node.*

All the processors in each node start up and execute the PAL code and subsequently enter the PEI Foundation. The BFV of a particular node must be accessible by all the processors running in that node. This distinction also means that some of the PEIMs in the Intel Itanium architecture boot path will be multi-processor-aware.

- *Firmware modules in a BFV must be organized such that PAL-A, PAL-B, and FIT binaries are always visible to all the processors in a node at the time of power-on.*

These binaries must be visible without any initialization of the system fabric.

```

//*****
// EFI_BOOT_MODE
//*****
typedef UINT32      EFI_BOOT_MODE;

#define
BOOT_WITH_FULL_CONFIGURATION                0x00
#define BOOT_WITH_MINIMAL_CONFIGURATION     0x01
#define
BOOT_ASSUMING_NO_CONFIGURATION_CHANGES    0x02
#define
BOOT_WITH_FULL_CONFIGURATION_PLUS_DIAGNOSTICS 0x03
#define
BOOT_WITH_DEFAULT_SETTINGS                0x04
#define
BOOT_ON_S4_RESUME                          0x05
#define
BOOT_ON_S5_RESUME                          0x06
#define
BOOT_ON_S2_RESUME                          0x10
#define
BOOT_ON_S3_RESUME                          0x11
#define
BOOT_ON_FLASH_UPDATE                       0x12
#define
BOOT_IN_RECOVERY_MODE                      0x20

0x21 - 0xF..F Reserved Encodings

```

Table 12.2 lists the values and descriptions of the boot modes.

Table 12.2 Boot Mode Register

REGISTER BIT(S)	VALUES	DESCRIPTIONS
MSBit-0	000000b	Boot with full configuration
	000001b	Boot with minimal configuration
	000010b	Boot assuming no configuration changes from last boot
	000011b	Boot with full configuration plus diagnostics
	000100b	Boot with default settings
	000101b	Boot on S4 resume
	000110b	Boot in S5 resume
	000111b-001111b	Reserved for boot paths that configure memory

010000b	Boot on S2 resume
010001b	Boot on S3 resume
010010b	Boot on flash update restart
010011b-011111b	Reserved for boot paths that preserve memory context
100000b	Boot in recovery mode
100001b-111111b	Reserved for special boots

Architectural Boot Mode PPIs

In the PEI chapter the concept of a PEIM-to-PEIM interface (PPI) is introduced as the unit of interoperability in this phase of execution. PEI modules can ascertain the boot mode via the `GetBootMode` service once the module is dispatched, but a system designer may not want a PEIM to even run unless in a given boot mode. A possible hierarchy of boot mode PPIs abstracts the various producers of the boot mode. It is a hierarchy in that there should be an order of precedence in which each mode can be set. The PPIs and their respective GUIDs are described in Required Architectural PPIs for the PEI phase that can be found in the PEI Core Interface Specification and Optional Architectural PPIs. The hierarchy includes the master PPI, which publishes a PPI depended upon by the appropriate PEIMs, and some subsidiary PPI. For PEIMs that require that the boot mode is finally known, the Master Boot Mode PPI can be used as a dependency.

Table 12.3 lists the architectural boot mode PPIs.

Table 12.3 Architectural Boot Mode PPIs

PPI Name	Required or Optional?	PPI Definition in Section...
Master Boot Mode PPI	Required	Architectural PPIs: Required Architectural PPIs
Boot in Recovery Mode PPI	Optional	Architectural PPIs: Optional Architectural PPIs

Recovery

This section describes platform firmware recovery. *Recovery* is an option to provide higher RASUM (Reliability, Availability, Usability, Manageability) in the field. Recovery is the process of reconstituting a system's firmware devices when they have become corrupted. The corruption can be caused by various mechanisms. Most firmware volumes (FVs) in nonvolatile storage (NVS) devices (flash or disk, for example) are managed as blocks. If the system loses power while a block, or semantically bound blocks, are being updated, the storage might become invalid. On the other hand, an errant program or hardware could corrupt the device. The system designers must determine the level of support for recovery based on their perceptions of the probabilities of these events occurring and the consequences.

Discovery

Discovering that recovery is required may be done using a PEIM (for example, by checking a “force recovery” jumper) or the PEI Foundation itself. The PEI Foundation might discover that a particular PEIM has not validated correctly or that an entire firmware has become corrupted.

Note	At this point a physical reset of the system has not occurred. The PEI Dispatcher has only cleared all state information and restarted itself.
-------------	--

It is possible that a PEIM could be built to handle the portion of the recovery that would initialize the recovery peripherals (and the buses they reside on) and then to read the new images from the peripherals and update the FVs.

It is considered far more likely that the PEI will transition to DXE because DXE is designed to handle access to peripherals. This has the additional benefit that, if DXE then discovers that a device has become corrupted, it may institute recovery without transferring control back to the PEI.

Since the PEI Foundation does not have a list of what to dispatch, how does it know if an area of invalid space in an FV should have contained a PEIM or not? The PEI Foundation should discover most corruption as an incidental result of its search for PEIMs. In this case, if the PEI Foundation completes its dispatch process without discovering enough static system memory to start DXE, then it should go into recovery mode.

Summary

This chapter has described the various boot modes that the UEFI PI firmware can support. This concept is important to understand as both a provider of PEI modules and DXE drivers, along with platform integrators. The former constituency needs to design their code to handle the boot modes appropriately, whereas the latter group of engineers needs to understand how to compose a set of modules and drivers for the respective boot paths of a resultant system.

Chapter 13

Pre-EFI Initialization (PEI)

Small is Beautiful

—E.F. Schumacher

The UEFI Platform Initialization (PI) Pre-EFI initialization (PEI) phase of execution has two primary roles in a platform's life: determine the source of the restart and provide a minimum amount of permanent memory for the ensuing DXE phase. Words such as small and minimal are often used to describe PEI code because of hardware resource constraints that limit the programming environment. Specifically, the Pre-EFI Initialization (PEI) phase provides a standardized method of loading and invoking specific initial configuration routines for the processor, chipset, and system board. The PEI phase occurs after the Security (SEC) phase. The primary purpose of code operating in this phase is to initialize enough of the system to allow instantiation of the Driver Execution Environment (DXE) phase. At a minimum, the PEI phase is responsible for determining the system boot path and initializing and describing a minimum amount of system RAM and firmware volume(s) that contain the DXE Foundation and DXE Architectural Protocols. As an application of Occam's razor to the system design, the minimum amount of activity should be orchestrated and located in this phase of execution; no more, no less.

Scope

The PEI phase is responsible for initializing enough of the system to provide a stable base for subsequent phases. It is also responsible for detecting and recovering from corruption of the firmware storage space and providing the restart reason (boot-mode).

Today's PC generally starts execution in a very primitive state, from the perspective of the boot firmware, such as BIOS or the UEFI PI. Processors might need updates to their internal microcode; the chipset (the chips that provide the interface between processors and the other major components of the system) require considerable initialization; and RAM requires sizing, location, and other initialization. The PEI phase is responsible for initializing these basic subsystems. The PEI phase is intended to provide a simple infrastructure by which a limited set of tasks can easily be accomplished to transition to the more advanced DXE phase. The PEI phase is intended to be responsible for only a very small subset of tasks that are required to boot the platform; in other words, it should perform only the minimal tasks that are required to start DXE. As improvements in the hardware occur, some of these tasks may migrate out of the PEI phase of execution.

Rationale

The design for PEI is essentially a miniature version of DXE that addresses many of the same issues. The PEI phase consists of several parts:

- A PEI Foundation
- One or more Pre-EFI Initialization Modules (PEIMs)

The goal is for the PEI Foundation to remain relatively constant for a particular processor architecture and to support add-in modules from various vendors for particular processors, chipsets, platforms, and other components. These modules usually cannot be coded without some interaction between one another and, even if they could, it would be inefficient to do so.

PEI is unlike DXE in that DXE assumes that reasonable amounts of permanent system RAM are present and available for use. PEI instead assumes that only a limited amount of temporary RAM exists and that it could be reconfigured for other uses during the PEI phase after permanent system RAM

has been initialized. As such, PEI does not have the rich feature set that DXE does. The following are the most obvious examples of this difference:

- DXE has a rich database of loaded images and protocols bound to those images.
- PEI lacks a rich module hierarchy such as the DXE driver model.

Overview

The PEI phase consists of some Foundation code and specialized drivers known as PEIMs that customize the PEI phase operations to the platform. It is the responsibility of the Foundation code to dispatch the plug-ins in a sequenced order and provide basic services. The PEIMs are analogous to DXE drivers and generally correspond to the components being initialized. It is expected that common practice will be that the vendor of the component will provide the PEIM, possibly in source form so the customer can quickly debug integration problems.

The implementation of the PEI phase is more dependent on the processor architecture than any other UEFI PI phase. In particular, the more resources that the processor provides at its initial or near initial state, the richer the PEI environment will be. As such, several parts of the following discussion note requirements for the architecture but are otherwise left less completely defined because they are specific to the processor architecture.

PEI can be viewed from both temporal and spatial perspectives. Figure 13.1 provides the overall UEFI PI boot phase. The spatial view of PEI can be found in Figure 13.2. This picture describes the layering of the UEFI PI components. This figure has often been referred to as the “H”. PEI comprises the lower half of the “H”. The temporal perspective entails “when” the PEI foundation and its associated modules execute. Figure 13.3 highlights the portions of Figure 13.1 that include PEI.

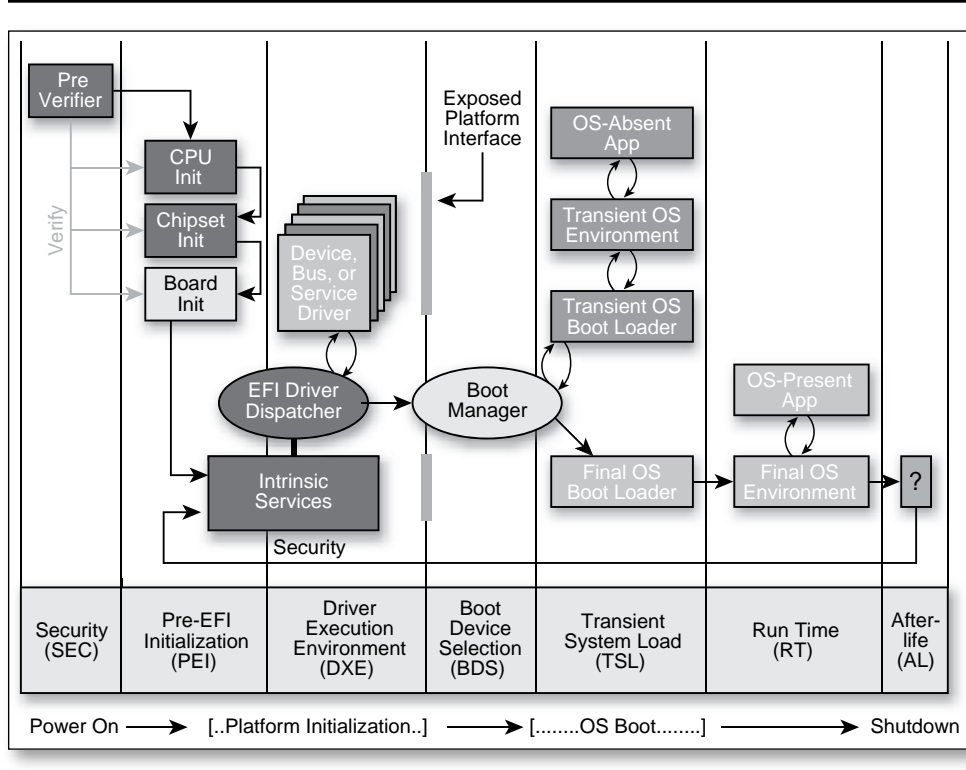

Figure 13.1 Overall Boot Flow

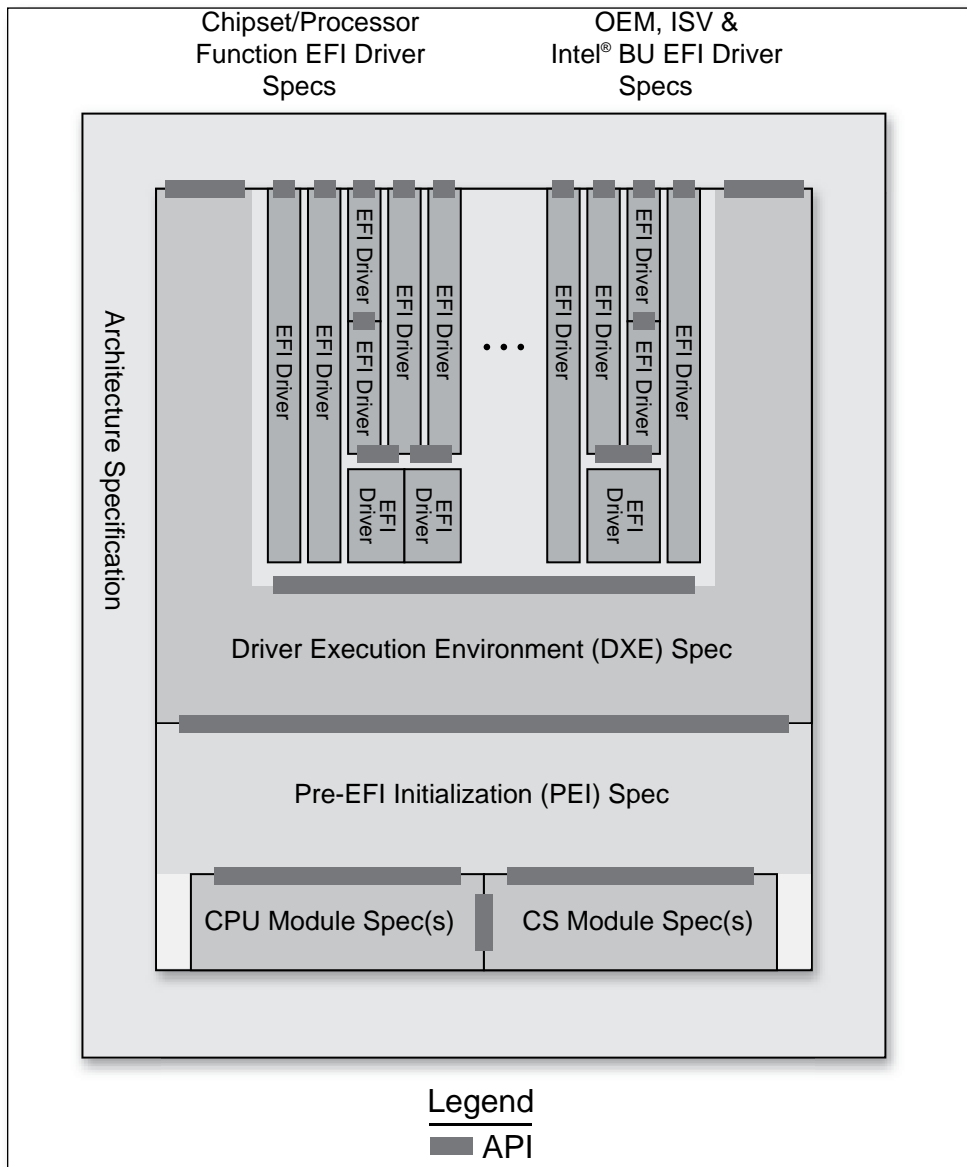

Figure 13.2 System Components

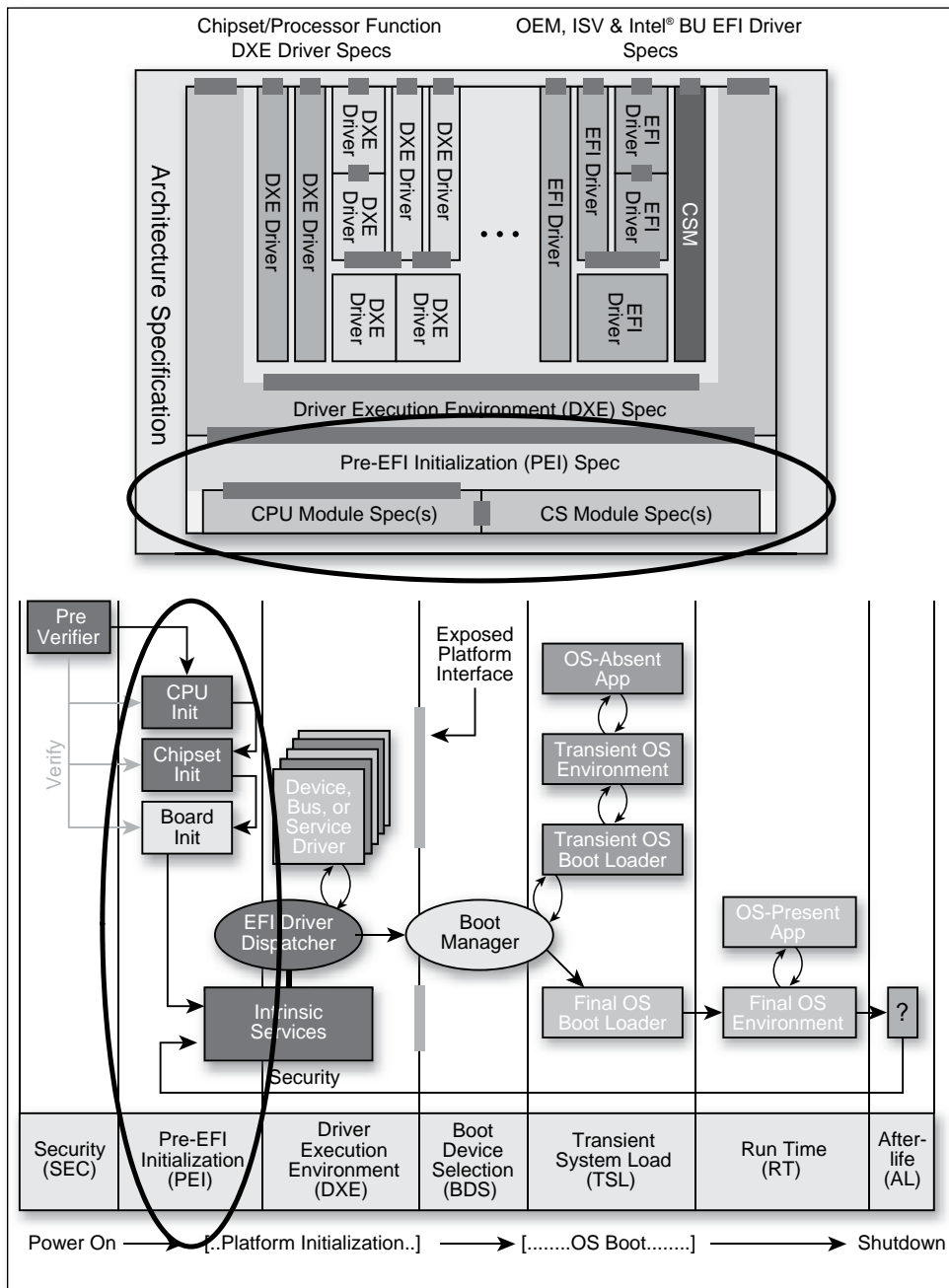

Figure 13.3 Portion of the Overall Boot Flow and Components for PEI

Phase Prerequisites

The following sections describe the prerequisites necessary for the successful completion of the PEI phase.

Temporary RAM

The PEI Foundation requires that the SEC phase initializes a minimum amount of scratch pad RAM that can be used by the PEI phase as a data store until system memory has been fully initialized. This scratch pad RAM should have access properties similar to normal system RAM—through memory cycles on the front side bus, for example. After system memory is fully initialized, the temporary RAM may be reconfigured for other uses. Typical provision for the temporary RAM is an architectural mode of the processor's internal caches.

Boot Firmware Volume

The Boot Firmware Volume (BFV) contains the PEI Foundation and PEIMs. It must appear in the memory address space of the system without prior firmware intervention and typically contains the reset vector for the processor architecture.

The contents of the BFV follow the format of the UEFI PI flash file system. The PEI Foundation follows the UEFI PI flash file system format to find PEIMs in the BFV. A platform-specific PEIM may inform the PEI Foundation of the location of other firmware volumes in the system, which allows the PEI Foundation to find PEIMs in other firmware volumes. The PEI Foundation and PEIMs are named by unique IDs in the UEFI PI flash file system.

The PEI Foundation and some PEIMs required for recovery must either be locked into a nonupdateable BFV or be able to be updated using a fault-tolerant mechanism. The UEFI PI flash file system provides error recovery; if the system halts at any point, either the old (preupdate) PEIM(s) or the newly updated PEIM(s) are entirely valid and the PEI Foundation can determine which is valid.

Security Primitives

The SEC phase provides an interface to the PEI Foundation to perform verification operations. To continue the root of trust, the PEI Foundation will use this mechanism to validate various PEIMs.

Concepts

The following sections describe the concepts in the PEI phase design.

PEI Foundation

The PEI Foundation is a single binary executable that is compiled to function with each processor architecture. It performs two main functions:

- Dispatching PEIMs
- Providing a set of common core services used by PEIMs

The PEI Dispatcher's job is to transfer control to the PEIMs in an orderly manner. The common core services are provided through a service table referred to as the PEI Services Table. These services do the following:

- Assist in PEIM-to-PEIM communication.
- Abstract management of the temporary RAM.
- Provide common functions to assist the PEIMs in the following:
 - Finding other files in the FFS
 - Reporting status codes
 - Preparing the handoff state for the next phase of the UEFI PI

When the SEC phase is complete, SEC invokes the PEI Foundation and provides the PEI Foundation with several parameters:

- The location and size of the BFV so that the PEI Foundation knows where to look for the initial set of PEIMs.
- A minimum amount of temporary RAM that the PEI phase can use.

- A verification service callback to allow the PEI Foundation to verify that PEIMs that it discovers are authenticated to run before the PEI Foundation dispatches them.

The PEI Foundation assists PEIMs in communicating with each other. The PEI Foundation maintains a database of registered interfaces for the PEIMs, as shown in Figure 13.4. These interfaces are called PEIM-to-PEIM Interfaces (PPIs). The PEI Foundation provides the interfaces to allow PEIMs to register PPIs and to be notified (called back) when another PEIM installs a PPI.

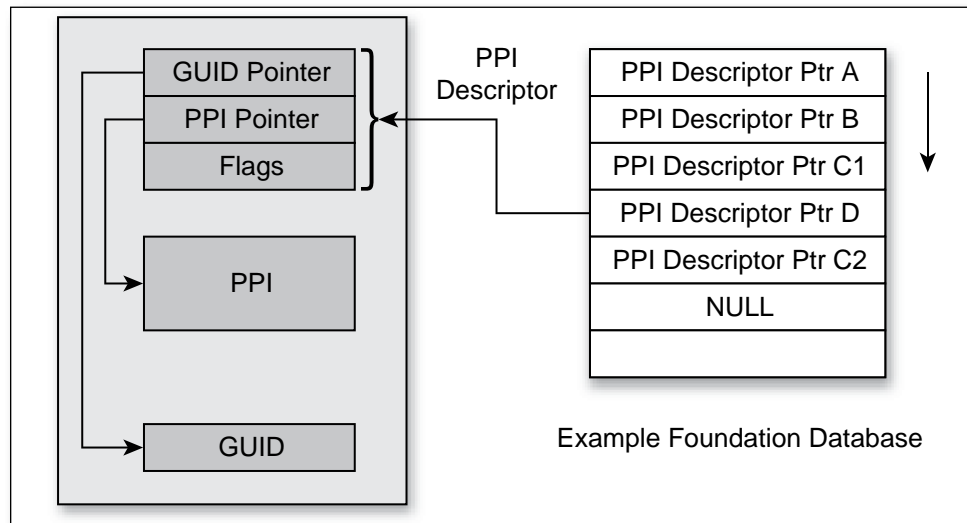

Figure 13.4 How a PPI Is Registered

The PEI Dispatcher consists of a single phase. It is during this phase that the PEI Foundation examines each file in the firmware volumes that contain files of type PEIM. It examines the dependency expression (depex) within each firmware file to decide if a PEIM can run. A dependency expression is code associated with each driver that describes the dependencies that must be satisfied for that driver to run. The binary encoding of dependency expressions for PEIMs is the same as that of dependency expressions associated with a DXE driver.

Pre-EFI Initialization Modules (PEIMs)

Pre-EFI Initialization Modules (PEIMs) are executable binaries that encapsulate processor, chipset, device, or other platform-specific functionality. PEIMs may provide interface(s) that allow other PEIMs or the PEI Foundation to communicate with the PEIM or the hardware for which the PEIM abstracts. PEIMs are separately built binary modules that typically reside in ROM and are therefore uncompressed. A small subset of PEIMs exist that may run from RAM for performance reasons. These PEIMs reside in ROM in a compressed format. PEIMs that reside in ROM are execute-in-place modules that may consist of either position-independent code or position-dependent code with relocation information.

PEI Services

The PEI Foundation establishes a system table named the PEI Services Table that is visible to all PEIMs in the system. A PEI service is defined as a function, command, or other capability that is manifested by the PEI Foundation when that service's initialization requirements are met. Because the PEI phase has no permanent memory available until nearly the end of the phase, the range of services created during the PEI phase cannot be as rich as those created during later phases. Because the location of the PEI Foundation and its temporary RAM is not known at build time, a pointer to the PEI Services Table is passed into each PEIM's entry point and also to part of each PPI. The PEI Foundation provides the following classes of services:

- *PPI Services*: Manages PPIs to facilitate intermodule calls between PEIMs. Interfaces are installed and tracked on a database maintained in temporary RAM.
- *Boot Mode Services*: Manages the boot mode (S3, S5, normal boot, diagnostics, and so on) of the system.
- *HOB Services*: Creates data structures called Hand-Off Blocks (HOBs) that are used to pass information to the next phase of the UEFI PI.
- *Firmware Volume Services*: Scans the FFS in firmware volumes to find PEIMs and other firmware files in the flash device.

- *PEI Memory Services*: Provides a collection of memory management services for use both before and after permanent memory has been discovered.
- *Status Code Services*: Common progress and error code reporting services, that is, port 080h or a serial port for simple text output for debug.
- *Reset Services*: Provides a common means by which to initiate a restart of the system.

PEIM-to-PEIM Interfaces (PPIs)

PEIMs may invoke other PEIMs through interfaces named PEIM-to-PEIM Interfaces (PPIs). The interfaces themselves are named using Globally Unique Identifiers (GUIDs) to allow the independent development of modules and their defined interfaces without naming collision. A GUID is a 128 bit value used to differentiate services and structures in the boot services. The PPIs are defined as structures that may contain functions, data, or a combination of the two. PEIMs must register their PPIs with the PEI Foundation, which manages a database of registered PPIs. A PEIM that wants to use a specific PPI can then query the PEI Foundation to find the interface it needs. The two types of PPIs are:

- Services
- Notifications

PPI services allow a PEIM to provide functions or data for another PEIM to use. PPI notifications allow a PEIM to register for a callback when another PPI is registered with the PEI Foundation.

Simple Heap

The PEI Foundation uses temporary RAM to provide a simple heap store before permanent system memory is installed. PEIMs may request allocations from the heap, but no mechanism exists to free memory from the heap. Once permanent memory is installed, the heap is relocated to permanent system memory, but the PEI Foundation does not fix up existing data within the heap.

Therefore, a PEIM cannot store pointers in the heap when the target is other data within the heap, such as linked lists.

Hand-Off Blocks (HOBs)

Hand-Off Blocks (HOBs) are the architectural mechanism for passing system state information from the PEI phase to the DXE phase in the UEFI PI architecture. A HOB is simply a data structure (cell) in memory that contains a header and data section. The header definition is common for all HOBs and allows any code using this definition to know two items:

- The format of the data section
- The total size of the HOB

HOBs are allocated sequentially in the memory that is available to PEIMs after permanent memory has been installed. A series of core services facilitate the creation and addition of HOBs during PEI. This sequential list of HOBs in memory is referred to as the *HOB list*. The first HOB in the HOB list must be the Phase Handoff Information Table (PHIT) HOB that describes the physical memory used by the PEI phase and the boot mode discovered during the PEI phase, as illustrated in Figure 13.5.

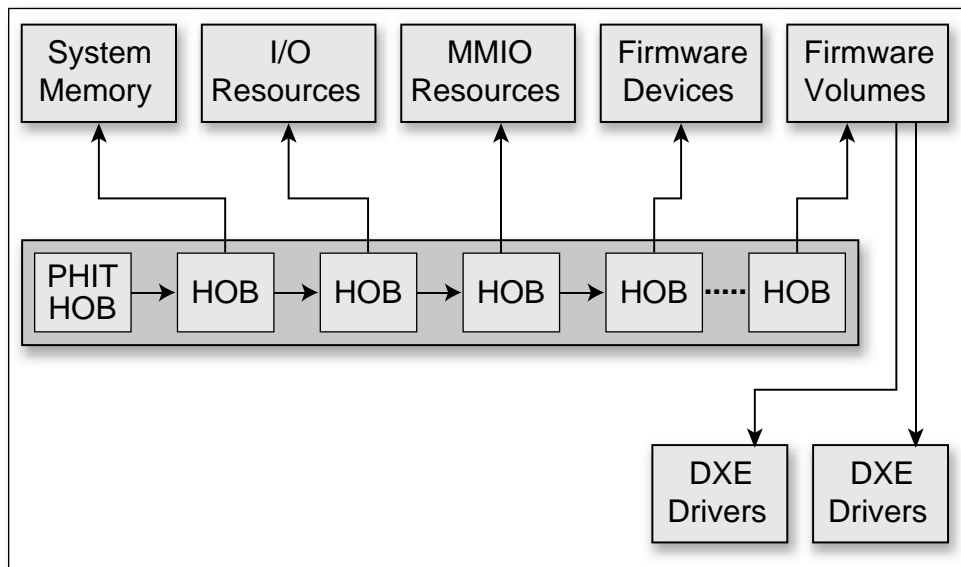

Figure 13.5 The HOB List

Only PEI components are allowed to make additions or changes to HOBs. Once the HOB list is passed into DXE, it is effectively read-only for DXE components. The ramifications of a read-only HOB list for DXE is that handoff information, such as boot mode, must be handled in a unique fashion; if DXE were to engender a recovery condition, it would not update the boot mode but instead would implement the action using a special type of reset call. The HOB list contains system state data at the time of PEI-to-DXE handoff and does not represent the current system state during DXE. DXE components should use services that are defined for DXE to get the current system state instead of parsing the HOB list.

As a guideline, it is expected that HOBs passed between PEI and DXE will follow a one producer-to-one consumer model. In other words, a PEIM will produce a HOB in PEI, and a DXE Driver will consume that HOB and pass information associated with that HOB to other DXE components that need the information. The methods that the DXE Driver uses to provide that information to other DXE components should follow mechanisms defined by the DXE architecture.

Operation

PEI phase operation consists of invoking the PEI Foundation, dispatching all PEIMs in an orderly manner, and discovering and invoking the next phase, as illustrated in Figure 13.6. During PEI Foundation initialization, the PEI Foundation initializes the internal data areas and functions that are needed to provide the common PEI services to PEIMs. During PEIM dispatch, the PEI Dispatcher traverses the firmware volume(s) and discovers PEIMs according to the flash file system definition. The PEI Dispatcher then dispatches PEIMs if the following criteria are met:

- The PEIM has not already been invoked.
- The PEIM file is correctly formatted.
- The PEIM is trustworthy.
- The PEIM's dependency requirements have been met.

After dispatching a PEIM, the PEI Dispatcher continues traversing the firmware volume(s) until either all discovered PEIMs have been invoked or no more PEIMs can be invoked because the requirements listed above cannot be met for any PEIMs. Once this condition has been reached, the PEI Dispatcher's job is complete and it invokes an architectural PPI for starting the next phase of the UEFI PI, the DXE Initial Program Load (IPL) PPI.

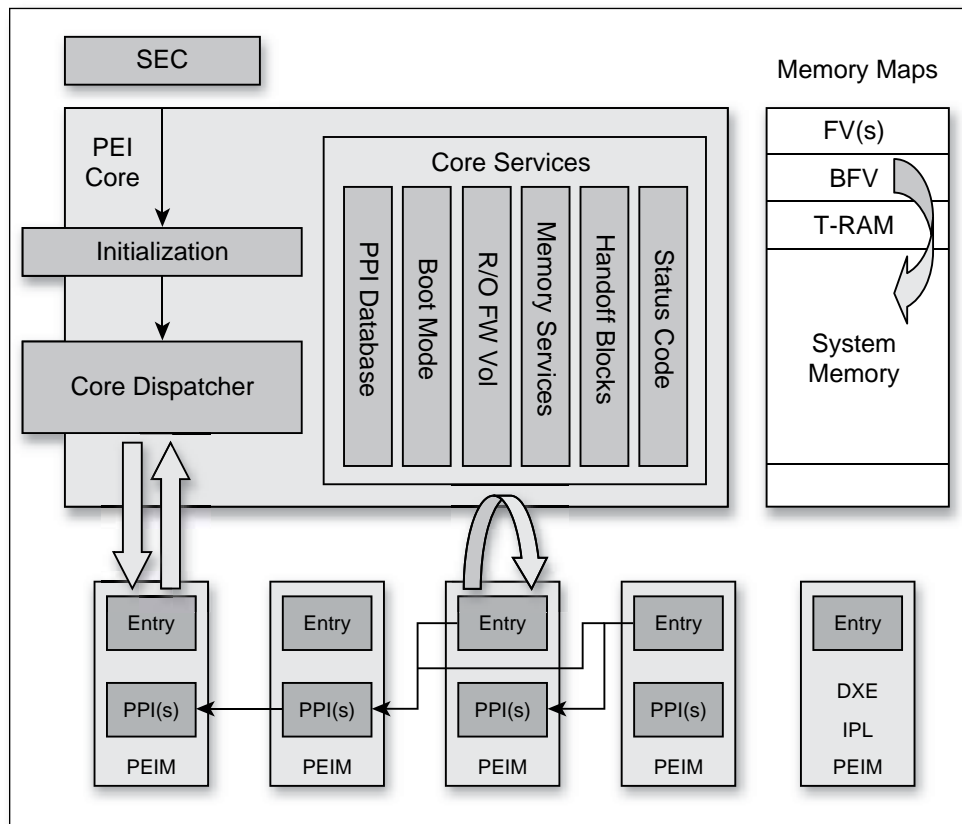

Figure 13.6 PEI Boot Flow

Dependency Expressions

The sequencing of PEIMs is determined by evaluating a *dependency expression* associated with each PEIM. This Boolean expression describes the requirements that are necessary for that PEIM to run, which imposes a weak ordering on

the PEIMs. Within this weak ordering, the PEIMs may be initialized in any order. The GUIDs of PPIs and the GUIDs of file names are referenced in the dependency expression. The dependency expression is a representative syntax of operations that can be performed on a plurality of dependencies to determine whether the PEIM can be run. The PEI Foundation evaluates this dependency expression against an internal database of run PEIMs and registered PPIs. Operations that may be performed on dependencies are the logical operators AND, OR, and NOT and the sequencing operators BEFORE and AFTER.

Verification/Authentication

The PEI Foundation is stateless with respect to security. Instead, security decisions are assigned to platform-specific components. The two components of interest that abstract security include the Security PPI and a Verification PPI. The purpose of the Verification PPI is to check the authentication status of a given PEIM. The mechanism used therein may include digital signature verification, a simple checksum, or some other OEM-specific mechanism. The result of this verification is returned to the PEI Foundation, which in turn conveys the result to the Security PPI. The Security PPI decides whether to defer execution of the PEIM or to let the execution occur. In addition, the Security PPI provider may choose to generate an attestation log entry of the dispatched PEIM or provide some other security exception.

PEIM Execution

PEIMs run to completion when invoked by the PEI Foundation. Each PEIM is invoked only once and must perform its job with that invocation and install other PPIs to allow other PEIMs to call it as necessary. PEIMs may also register for a notification callback if it is necessary for the PEIM to get control again after another PEIM has run.

Memory Discovery

Memory discovery is an important architectural event during the PEI phase. When a PEIM has successfully discovered, initialized, and tested a contiguous range of system RAM, it reports this RAM to the PEI Foundation. When that PEIM exits, the PEI Foundation migrates PEI usage of the temporary RAM to real system RAM, which involves the following two tasks:

- The PEI Foundation must switch PEI stack usage from temporary RAM to permanent system memory.
- The PEI Foundation must migrate the simple heap allocated by PEIMs (including HOBs) to real system RAM.

Once this process is complete, the PEI Foundation installs an architectural PPI to notify any interested PEIMs that real system memory has been installed. This notification allows PEIMs that ran before memory was installed to be called back so that they can complete necessary tasks—such as building HOBs for the next phase of DXE—in real system memory.

Intel® Itanium® Processor MP Considerations

This section gives special consideration to the PEI phase operation in Intel Itanium processor family multiprocessor (MP) systems. In Itanium-based systems, all of the processors in the system start up simultaneously and execute the PAL initialization code that is provided by the processor vendor. Then all the processors call into the UEFI PI start-up code with a request for recovery check. The start-up code allocates different chunks of temporary memory for each of the active processors and sets up stack and backing store pointers in the allocated temporary memory. The temporary memory could be a part of the processor cache (cache as RAM), which can be configured by invoking a PAL call. The start-up code then starts dispatching PEIMs on each of these processors. One of the early PEIMs that runs in MP mode is the PEIM that selects one of the processors as the boot-strap processor (BSP) for running the PEIM stage of the booting.

This BSP continues to run PEIMs until it finds permanent memory and installs the memory with the PEI Foundation. Then the BSP wakes up all the processors to determine their health and PAL compatibility status. If none of these checks warrants a recovery of the firmware, the processors are returned to the PAL for more processor initialization and a normal boot.

The UEFI PI start-up code also gets triggered in an Itanium-based system whenever an INIT or a Machine Check Architecture (MCA) event occurs in the system. Under such conditions, the PAL code outputs status codes and a buffer called the *minimum state buffer*. A UEFI PI-specific data pointer that points to the INIT and MCA code data area is attached to this minimum state buffer, which contains details of the code to be executed upon INIT and MCA

events. The buffer also holds some important variables needed by the start-up code to make decisions during these special hardware events.

Recovery

Recovery is the process of reconstituting a system's firmware devices when they have become corrupted. The corruption can be caused by various mechanisms. Most firmware volumes on nonvolatile storage devices are managed as blocks. If the system loses power while a block or semantically bound blocks are being updated, the storage might become invalid. On the other hand, the device might become corrupted by an errant program or by errant hardware. Assuming PEI lives in a fault-tolerant block, it can support a recovery mode dispatch.

A PEIM or the PEI Foundation itself can discover the need to do recovery. A PEIM can check a "force recovery" jumper, for example, to detect a need for recovery. The PEI Foundation might discover that a particular PEIM does not validate correctly or that an entire firmware volume has become corrupted.

The concept behind recovery is that enough of the system firmware is preserved so that the system can boot to a point that it can read a copy of the data that was lost from chosen peripherals and then reprogram the firmware volume with that data.

Preservation of the recovery firmware is a function of the way the firmware volume store is managed. In the UEFI PI flash file system, PEIMs required for recovery are marked as such. The firmware volume store architecture must then preserve marked items, either by making them unalterable (possibly with hardware support) or protect them using a fault-tolerant update process.

Until recovery mode has been discovered, the PEI Dispatcher proceeds as normal. If the PEI Dispatcher encounters PEIMs that have been corrupted (for example, by receiving an incorrect hash value), it must change the boot mode to recovery. Once set to recovery, other PEIMs must not change it to one of the other states. After the PEI Dispatcher has discovered that the system is in recovery mode, it will restart itself, dispatching only those PEIMs that are required for recovery. It is also possible for a PEIM to detect a catastrophic condition or to be a forced-recovery detect PEIM and to inform the PEI Dispatcher that it needs to proceed with a recovery dispatch. The recovery dispatch is completed when a PEIM finds a recovery firmware volume on a recovery media and the DXE Foundation is started from that firmware volume. Drivers within that DXE firmware volume can perform the recovery process.

S3 Resume

The PEI phase on S3 resume (save-to-RAM resume) differs in several fundamental ways from the PEI phase on a normal boot. The differences are as follows:

- The memory subsection is restored to its presleep state rather than initialized.
- System memory owned by the OS is not used by either the PEI Foundation or the PEIMs.
- The DXE phase is not dispatched on a resume because it would corrupt memory.
- The PEIM that would normally dispatch the DXE phase instead uses a special Hardware Save Table to restore fundamental hardware back to a boot configuration. After restoring the hardware, the PEIM passes control to the OS-supplied resume vector.
- The DXE and later phases during a normal boot save enough information in the UEFI PI reserved memory or a firmware volume area for hardware to be restored to a state that the OS can use to restore devices. This saved information is located in the Hardware Save Table.

The “Terse Executable” and Cache-as-RAM

The flash storage where the PEI modules and core execute has several constraints. The first is that the amount of flash allocated for PEI is limited. This stems both from the economics of system board design and from the fact that the PEI phase supports critical operations, such as crisis recovery and early memory initialization. These robustness requirements mean that many systems have two instances of PEI: a backup and/or truly read-only one that never changes and may only be used for recovery and a security root-of-trust, and a second PEI block used for normal boots that is the dual of the former one. Also, the execute-in-place (XIP) nature of code-fetches from flash means that PEI is not as performant as DXE modules that are loaded into host memory. In order to minimize the amount of space occupied by the PEI firmware volume (FV),

the Terse Executable (TE) image format was designed. The TE image format is a strict subset of the Portable Executable/Common File Format (PE/COFF) image used by UEFI applications, UEFI drivers, and DXE drivers.

The advantages of having TE as a subset of PE include the ability to use standard, available tools, such as linkers, which can be used during the development process. Only during the final phases of the FV image creation does the tool chain need to convert the PE image into a TE. This similarity extends to the headers and the relocation records. In order to have an in-situ agent, such as a debugger nub, distinguish between the PE and TE images, the signature field has been slightly modified. For the PE the signature is “MZ” for Mark Zbikowski, the designer of the Microsoft DOS[†] image format, the origin of the PE/COFF image. For the TE image, the signature is “VZ”, as found at the end of Volume 1 of the UEFI PI specification:

```
#define EFI_TE_IMAGE_HEADER_SIGNATURE 0x5A56 // "VZ"
```

This one character difference allows for sharing of debug scripts and code that only need to distinguish between the PE and TE via this one character of the signature field. Although the development and design team eschewed use of proper names in code or the resultant binaries, the “VZ” and “Vincent Zimmer” association appeared harmless, especially given the interoperability advantages.

In addition to the TE image, the “temporary memory” used during PEI is another innovation on Intel architecture platforms. Recall that the goal of PEI is to provide a basic system fabric initialization and some subset of memory that will be available throughout DXE, UEFI, and the operating system runtime. In order to program a modern CPU, memory controller, and interconnect, thousands of lines of C code may be required. In the spirit of using standard tools to write this code, though, some memory store prior to the permanent Dynamic RAM (DRAM) needed to be found.

Other approaches to this challenge in the past include the Coreboot use of the read-only-memory C compiler (romcc), or a compiler that uses processor registers as the “temporary memory.” This approach has proven difficult to maintain and entails a custom compiler. The other approach is to have dedicated memory on the platform immediately available after reset. Given the economics of modern systems and the transitory usage of this store, the use of discrete memory as a scratchpad has proven difficult to provide in anything other than the high-end system or extremely low-end, nontraditional systems. The approach taken for the bulk of Intel architecture systems is to use the processor

cache as a memory store, or cache-as-RAM (CAR). Although the initialization sequence is unique per architecture instance (for example, Itanium® versus Core2® versus Core i7®), the end result is some directly addressable memory after exiting the SEC phase and entering PEI. As a result, PEIMs and a PEI core can be written in C using commonly available C compilers, such as Microsoft cl.exe in Visual Studio[†] and the GNU C compiler (GCC) available in the open source community. The UEFI Developer Kit, such as the PEI core in the Module Development Environment (MDE) module package at www.tianocore.org, provides such as example of a generic PEI Core source collection.

Example System

All of the concepts regarding PEI can be synthesized when reviewing a specific platform. The following list represents an 865 system with all of the associated system components. This same system is also shown in Figure 13.7, which includes the actual silicon components. Figure 13.8 provides an idealized version of this same system. The components in the latter figure have corresponding PEIMs to abstract both the initialization of and services by the components. For each of these components, one to several PEI Modules can be delivered that abstract the specific component's behavior. An example of these components can include:

- Pentium® 4 processor PEIM: Initialization and CPU I/O service
- PCI Configuration PEIM: PCI Configuration PPI
- ICH PEIM: ICH initialization and the SMBUS PPI
- Memory initialization PEIM: Reading SPD through the SMBUS PPI, initialization of the memory controller, and reporting memory available to the PEI core
- Platform PEIM: Creation of the flash mode, detection of boot mode
- DXE IPL: Generic services to launch DXE, invoke S3 or recovery flow

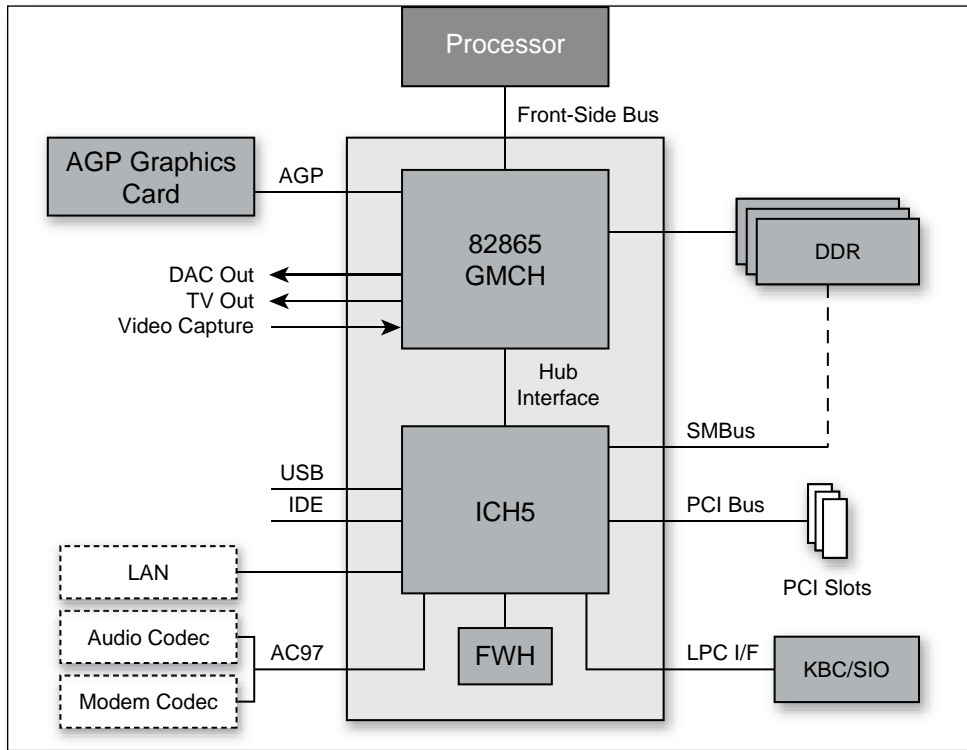

Figure 13.7 Specific System

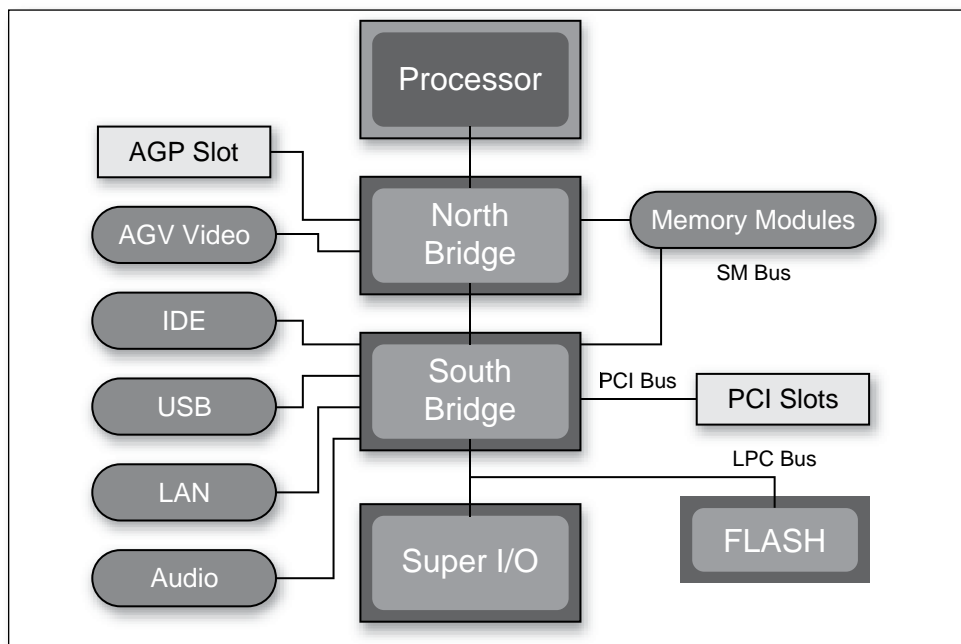

Figure 13.8 Idealization of Actual System

```

typedef
EFI_STATUS
(EFI_API *PEI_SMBUS_PPI_EXECUTE_OPERATION) (
    IN      EFI_PEI_SERVICE      **PeiServices,
    IN      struct EFI_PEI_SMBUS_PPI *This,
    IN      EFI_SMBUS_DEVICE_ADDRESS SlaveAddress,
    IN      EFI_SMBUS_DEVICE_COMMAND Command,
    IN      EFI_SMBUS_OPERATION   Operation,
    IN      BOOLEAN               PecCheck,
    IN OUT  UINTN                 *Length,
    IN OUT  VOID                  *Buffer
);

typedef struct {
    PEI_SMBUS_PPI_EXECUTE_OPERATION Execute;
    PEI_SMBUS_PPI_ARP_DEVICE        ArpDevice;
} EFI_PEI_SMBUS_PPI;
  
```

Figure 13.9 Instance of a PPI

What is notable about a PPI is that it is like an EFI protocol in that it has member services and/or static data. The PPI is named by a GUID and can have several instances. The SMBUS PPI, for example, could be implemented for SMBUS controllers in the ICH, in another vendor's integrated Super I/O (SIO), or other component. Figure 13.10 illustrates an instance of an SMBUS PPI for an Intel ICH.

```
#define SMBUS_R_HD0  0xEFA5
#define SMBUS_R_HBD  0xEFA7

EFI_PEI_SERVICES      *PeiServices;
SMBUS_PRIVATE_DATA    *Private;
UINT8  Index, BlockCount *Length;
UINT8  *Buffer;

BlockCount = Private->CpuIo.IoRead8 (
    *PeiServices, Private->CpuIo, SMBUS_R_HD0);
if (*Length < BlockCount) {
    return EFI_BUFFER_TOO_SMALL;
} else {
    for (Index = 0; Index < BlockCount; Index++) {
        Buffer[Index] = Private->CpuIo.IoRead8 (
            *PeiServices, Private->CpuIo, SMBUS_R_HBD);
    }
}
}
```

Figure 13.10 Code that Supports a PPI Service

Summary

This chapter has provided an overview of the PEI phase of the UEFI PI environment. PEI provides a unique combination of software modularity so that various business interests can provide modules, while at the same time have purpose-built technologies to support the robustness and resource constraints of such an early phase of machine execution. Aspects of PEI discussed in this chapter include the concept of temporary memory, the PEI Core services, PEI relative to other UEFI PI components, recovery, and some sample PEI modules.

Putting It All Together— Firmware Emulation

An expert is a man who has made all the mistakes which can be made in a very narrow field.

—Niels Bohr

In the preceding chapters, various stages of the firmware initialization process have been described. In addition, various possible usage models have been described that can be implemented on a target hardware platform. In addition, by now it should have become evident that many of the UEFI firmware interfaces do not in and of themselves directly talk to hardware; instead they actually talk to underlying components that are responsible for talking to hardware. Traditionally, firmware development has not been an activity that could be performed without an in-circuit emulator (ICE) or other hardware debug facility. Taking into consideration UEFI's design and the fact that very few components in the firmware actually have direct interaction with hardware devices, it is possible to introduce a mechanism that allows the emulation of vast amounts of the firmware in a standard deployment operation system environment.

In the UEFI sample implementation, a new target platform was introduced called NT32. This environment features the ability to run much of the firmware code as an application running from the operating system, and provides the ability to establish a robust development and debug environment. Much of the firmware codebase was developed initially using the emulation environment with off-the-shelf compilers and debuggers, and

without the need of a real hardware debugger. Of course, this emulation has its limitations, since some components of the firmware must talk to hardware. It is much more difficult to emulate such components, though later in this chapter, some possibilities are discussed to alleviate some of this issue. Figure 14.1 shows an example of a firmware emulation environment running the UEFI shell within an operating system context.

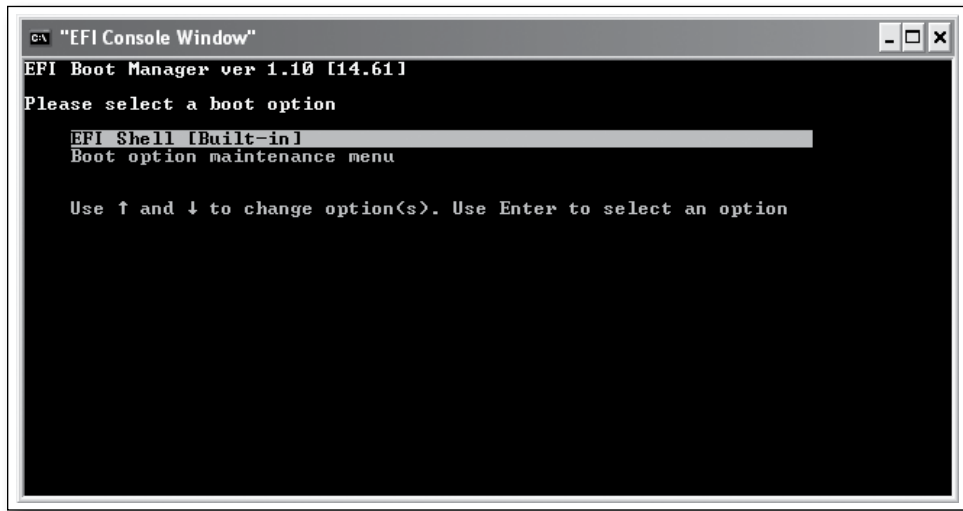

Figure 14.1 An Emulation Environment Contained within an Operating System Environment

Virtual Platform

This NT32 platform can be described as a hardware-agnostic platform in that it uses operating system APIs for its primary hardware abstractions. Figure 14.2 shows how the firmware emulation environment gets launched. It is part of a normal boot process, and will essentially launch a firmware emulation environment as an application running from the operating system. For most developers, this simply means launching a standard platform, loading an operating system, and then building and executing the NT32 emulation environment as a native operating system application. This application effectively executes the firmware that was built, and emulates the launch of a new system.

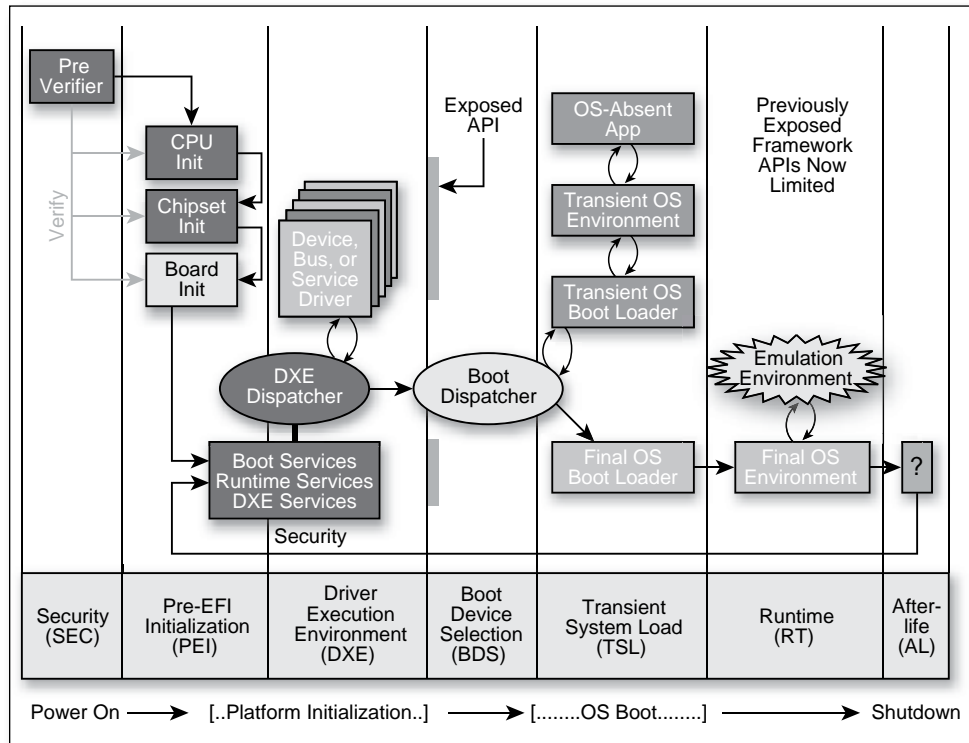

Figure 14.2 The Normal Boot Process Launching an Operating System that Will Launch the Emulation Environment

In Figure 14.3, the timeline is actually intended to illustrate the emulated firmware timeline. It has the capability of processing all of the firmware evolution stages, yet of course certain operations are emulated due to lack of direct hardware initialization. An example would be the direct initialization of memory, which would be somewhat different in this environment, whereas in a real platform, this process would be much more involved.

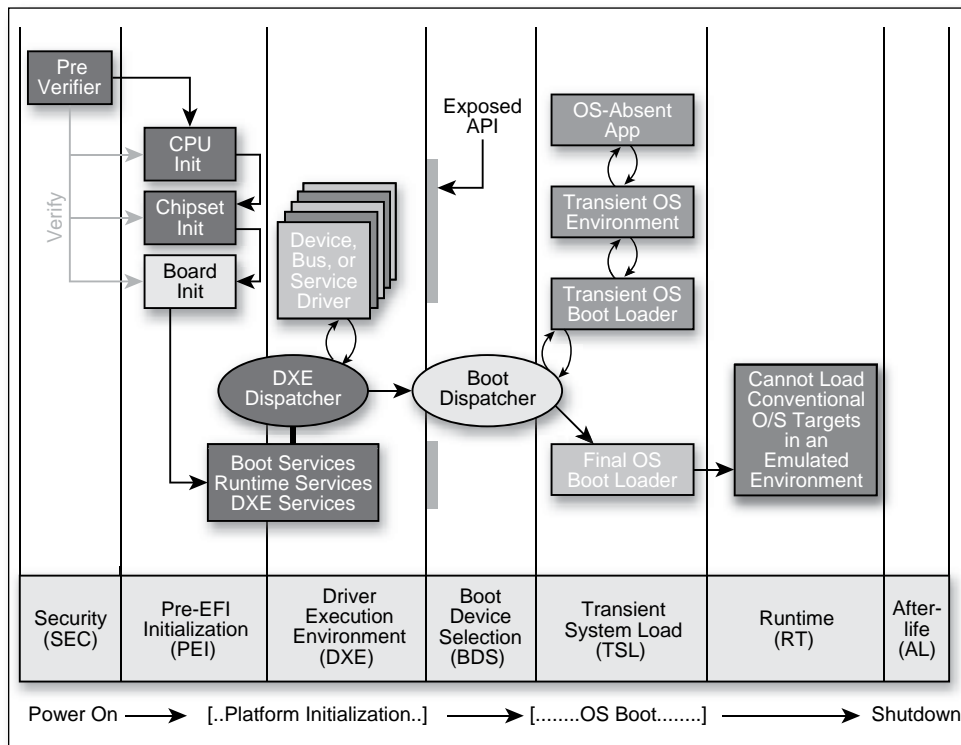

Figure 14.3 The Firmware Emulation Environment Itself

Emulation Firmware Phases

It should be noted that the emulation environment has several distinct phases:

- Establishing a WinNtThunk capability for the emulation environment.

This phase constructs a means by which firmware components can make reference to some “hardware” components. This is done by associating firmware-visible constructs that will then be associated with operating system native API calls.

Figure 14.4 is an example where several firmware constructs are being associated with operating system native APIs. For example, to create a file, we establish a firmware calling mechanism (such as WinNtCreateFile) to call an operating system API known as CreateFile.

The following examples illustrate a mechanism of associating firmware calls to Windows APIs, but this could just as easily happen for any underlying operation system.

```

typedef struct {
    UINT64                                     Signature;

    //
    // Win32 Process APIs
    //
    WinNtGetProcAddress                       GetProcAddress;
    WinNtGetTickCount                         GetTickCount;
    WinNtLoadLibraryEx                       LoadLibraryEx;
    WinNtFreeLibrary                         FreeLibrary;
    WinNtSetPriorityClass                     SetPriorityClass;
    WinNtSetThreadPriority                   SetThreadPriority;
    WinNtSleep                               Sleep;
    WinNtSuspendThread                       SuspendThread;
    WinNtGetCurrentThread                   GetCurrentThread;
    WinNtGetCurrentThreadId                 GetCurrentThreadId;
    WinNtGetCurrentProcess                   GetCurrentProcess;
    WinNtCreateThread                       CreateThread;
    WinNtTerminateThread                   TerminateThread;
    WinNtSendMessage                       SendMessage;
    WinNtExitThread                         ExitThread;
    WinNtResumeThread                       ResumeThread;
    WinNtDuplicateHandle                    DuplicateHandle;

    //
    // Wint32 Mutex primitive
    //
    WinNtInitializeCriticalSection          InitializeCriticalSection;
    WinNtEnterCriticalSection              EnterCriticalSection;
    WinNtLeaveCriticalSection              LeaveCriticalSection;
    WinNtDeleteCriticalSection            DeleteCriticalSection;
    WinNtTlsAlloc                          TlsAlloc;
    WinNtTlsFree                            TlsFree;
    WinNtTlsSetValue                       TlsSetValue;
    WinNtTlsGetValue                       TlsGetValue;
    WinNtCreateSemaphore                   CreateSemaphore;
    WinNtWaitForSingleObject               WaitForSingleObject;
    WinNtReleaseSemaphore                  ReleaseSemaphore;

    //
    // Win32 Console APIs
    //
    WinNtCreateConsoleScreenBuffer         CreateConsoleScreenBuffer;
    WinNtFillConsoleOutputAttribute       FillConsoleOutputAttribute;
    WinNtFillConsoleOutputCharacter       FillConsoleOutputCharacter;

```

```

WinNtGetConsoleCursorInfo           GetConsoleCursorInfo;
WinNtGetNumberOfConsoleInputEvents  GetNumberOfConsoleInputEvents;
WinNtPeekConsoleInput               PeekConsoleInput;
WinNtScrollConsoleScreenBuffer      ScrollConsoleScreenBuffer;
WinNtReadConsoleInput               ReadConsoleInput;
WinNtSetConsoleActiveScreenBuffer   SetConsoleActiveScreenBuffer;
WinNtSetConsoleCursorInfo           SetConsoleCursorInfo;
WinNtSetConsoleCursorPosition       SetConsoleCursorPosition;
WinNtSetConsoleScreenBufferSize     SetConsoleScreenBufferSize;
WinNtSetConsoleTitleW               SetConsoleTitleW;
WinNtWriteConsoleInput              WriteConsoleInput;
WinNtWriteConsoleOutput              WriteConsoleOutput;

//
// Win32 File APIs
//
WinNtCreateFile                     CreateFile;
WinNtDeviceIoControl                DeviceIoControl;
WinNtCreateDirectory                CreateDirectory;
WinNtRemoveDirectory                RemovedDirectory;
WinNtGetFileAttributes              GetFileAttributes;
WinNtSetFileAttributes              SetFileAttributes;
WinNtCreateFileMapping              CreateFileMapping;
WinNtCloseHandle                    CloseHandle;
WinNtDeleteFile                     DeleteFile;
WinNtFindFirstFile                  FindFirstFile;
WinNtFindNextFile                   FindNextFile;
WinNtFindClose                       FindClose;
WinNtFlushFileBuffers               FlushFileBuffers;
WinNtGetEnvironmentVariable          GetEnvironmentVariable;
WinNtGetLastError                    GetLastError;
WinNtSetErrorMode                    SetErrorMode;
WinNtGetStdHandle                    GetStdHandle;
WinNtMapViewOfFileEx                MapViewOfFileEx;
WinNtReadFile                        ReadFile;
WinNtSetEndOfFile                    SetEndOfFile;
WinNtSetFilePointer                  SetFilePointer;
WinNtWriteFile                       WriteFile;
WinNtGetFileInformationByHandle      GetFileInformationByHandle;
WinNtGetDiskFreeSpace                GetDiskFreeSpace;
WinNtGetDiskFreeSpaceEx              GetDiskFreeSpaceEx;
WinNtMoveFile                        MoveFile;
WinNtSetFileTime                      SetFileTime;
WinNtSystemTimeToFileTime            SystemTimeToFileTime;

//
// Win32 Time APIs
//
WinNtFileTimeToLocalFileTime         FileTimeToLocalFileTime;
WinNtFileTimeToSystemTime            FileTimeToSystemTime;

```



```

WinNtGetSystemTime           GetSystemTime;
WinNtSetSystemTime          SetSystemTime;
WinNtGetLocalTime           GetLocalTime;
WinNtSetLocalTime           SetLocalTime;
WinNtGetTimeZoneInformation GetTimeZoneInformation;
WinNtSetTimeZoneInformation SetTimeZoneInformation;
WinNttimeSetEvent           timeSetEvent;
WinNttimeKillEvent          timeKillEvent;

//
// Win32 Serial APIs
//
WinNtClearCommError          ClearCommError;
WinNtEscapeCommFunction      EscapeCommFunction;
WinNtGetCommModemStatus      GetCommModemStatus;
WinNtGetCommState            GetCommState;
WinNtSetCommState            SetCommState;
WinNtPurgeComm               PurgeComm;
WinNtSetCommTimeouts        SetCommTimeouts;

WinNtExitProcess             ExitProcess;
WinNtSprintf                 SPrintf;
WinNtGetDesktopWindow        GetDesktopWindow;
WinNtGetForegroundWindow     GetForegroundWindow;
WinNtCreateWindowEx          CreateWindowEx;
WinNtShowWindow              ShowWindow;
WinNtUpdateWindow            UpdateWindow;
WinNtDestroyWindow           DestroyWindow;
WinNtInvalidateRect          InvalidateRect;
WinNtGetWindowDC             GetWindowDC;
WinNtGetClientRect           GetClientRect;
WinNtAdjustWindowRect        AdjustWindowRect;
WinNtSetDIBitsToDevice        SetDIBitsToDevice;
WinNtBitBlt                  BitBlt;
WinNtGetDC                   GetDC;
WinNtReleaseDC               ReleaseDC;
WinNtRegisterClassEx         RegisterClassEx;
WinNtUnregisterClass         UnregisterClass;

WinNtBeginPaint              BeginPaint;
WinNtEndPaint                EndPaint;
WinNtPostQuitMessage         PostQuitMessage;
WinNtDefWindowProc           DefWindowProc;
WinNtLoadIcon                LoadIcon;
WinNtLoadCursor              LoadCursor;
    WinNtGetStockObject        GetStockObject;
    WinNtSetViewportOrgEx      SetViewportOrgEx;
    WinNtSetWindowOrgEx        SetWindowOrgEx;
    WinNtMoveWindow            MoveWindow;
    WinNtGetWindowRect         GetWindowRect;

```

```

WinNtGetMessage           GetMessage;
WinNtTranslateMessage     TranslateMessage;
WinNtDispatchMessage     DispatchMessage;
WinNtGetProcessHeap      GetProcessHeap;
WinNtHeapAlloc           HeapAlloc;
WinNtHeapFree            HeapFree;
} EFI_WIN_NT_THUNK_PROTOCOL;

```

Figure 14.4 Thunk Protocol that Associates Some Firmware Names with Operating System APIs

- Construct a UEFI hardware API handler that will be specific to the emulation platform.

In Figure 14.5, the `EFI_SERIAL_IO_PROTOCOL` interface is being seeded with a variety of information associated with platform specific function data. In this case, these platform-specific functions are tuned to the emulation environment.

```

SerialIo.Revision        = SERIAL_IO_INTERFACE_REVISION;
SerialIo.Reset           = WinNtSerialIoReset;
SerialIo.SetAttributes   = WinNtSerialIoSetAttributes;
SerialIo.SetControl      = WinNtSerialIoSetControl;
SerialIo.GetControl      = WinNtSerialIoGetControl;
SerialIo.Write           = WinNtSerialIoWrite;
SerialIo.Read            = WinNtSerialIoRead;
SerialIo.Mode            = SerialIoMode;

```

Figure 14.5 Establishing a UEFI API to Call Platform-Specific Operations

Platform-specific functions (such as emulation platform) that are handling the calls to UEFI interfaces and in turn will call the established `WinNtThunk` APIs that will end up making operating specific API calls.

In Figure 14.6 are illustrated several calls that could occur from within an API handler to accomplish several tasks.

```
//  
// Example of reading from a file  
//  
Result = WinNtThunk->ReadFile (  
    NtHandle,  
    Buffer,  
    (DWORD)*BufferSize,  
    &BytesRead,  
    NULL  
);  
  
//  
// Example of resetting a serial device  
//  
WinNtThunk->PurgeComm (  
    NtHandle,  
    PURGE_TXCLEAR | PURGE_RXCLEAR  
);  
  
//  
// Example of getting local time components  
//  
WinNtThunk->GetLocalTime (&SystemTime);  
WinNtThunk->GetTimeZoneInformation (&TimeZone);
```

Figure 14.6 Example Calls to the WinNtThunk Protocol

In summary, Figure 14.7 shows the software logic contained within the operating system, firmware emulation component, and their associated interaction logic. It should be noted that this logical software flow has three primary components:

- Firmware component under development
- Basic firmware codebase
- Firmware-to-Operating System thunk code

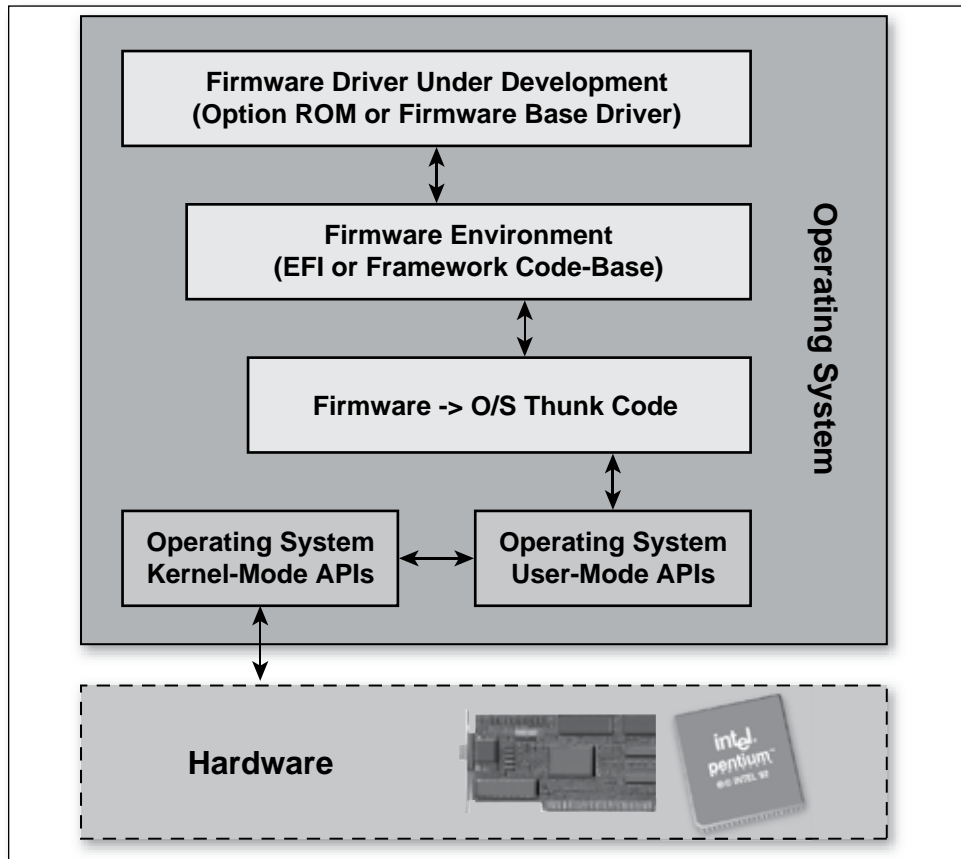

Figure 14.7 Firmware Emulation Software Logic Flow

Hardware Pass-Through

As is evident through the previous examples, the underlying firmware can enable calling to several operating system APIs. However, since the firmware emulation environment is essentially an operating system application, certain functions are not going to be available. This is true since most operating systems have the concept of separating a user space from a more privileged kernel space to prevent applications from inadvertently crashing the entire operating system. Using this type of separation allows for the operating system to detect an error

and simply kill the user session without perturbing the remaining portions of the operating system.

It is possible to introduce several extensions to what is currently defined in the sample implementations that enable even further capabilities. An operating system kernel driver could be constructed to facilitate access to even more functions than would otherwise be available. This of course circumvents some of the inherent safety of the operating system and can introduce inadvertent crashes when care is not taken. By constructing a kernel driver that can reserve certain hardware resources and is able to advertise an interface that the emulation environment can call, the emulation environment can allow for an enhanced penetration into the hardware.

Figure 14.8 shows the logic flow associated with the various components and how they interact.

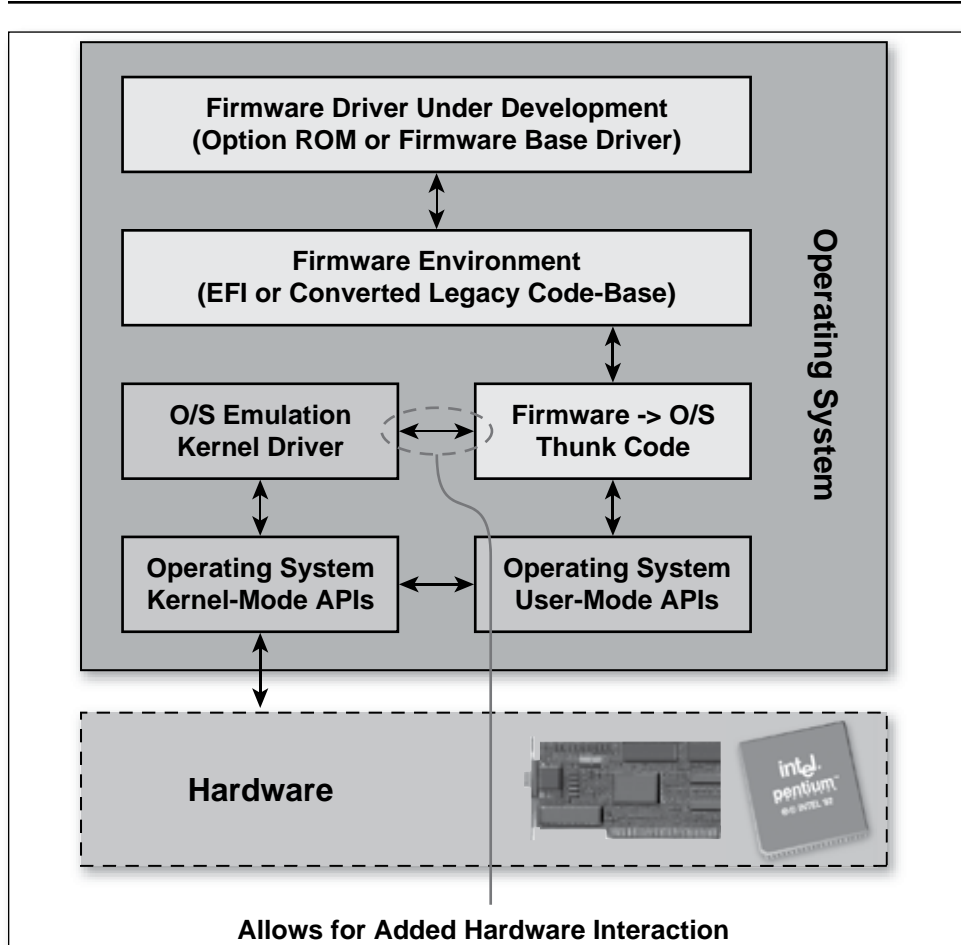

Figure 14.8 Software Flow for Hardware Enhanced Firmware Emulation

Summary

This chapter shows how the majority of the UEFI code can be run in an emulated environment so that development can occur on some modules even in absence of physical hardware that would otherwise have been necessary. This emulation, which is publicly available, advances the accessibility of the overall UEFI programming infrastructure. It can also facilitate a wider distribution of its use due to the relative simplicity of establishing such a development environment.

Chapter 15

Reducing Platform Boot Times

All problems are either kernel or BIOS problems depending on which context you are running in!

—Rothman's Axiom

This chapter presents a series of methods that should enable a BIOS engineer to optimize the underlying platform firmware so that it can reduce a platform's boot speed. However, it should be noted that the intent of this chapter is to illustrate how various, seemingly unrelated, product requirements can greatly affect the resulting platform boot performance. That being said, this section also illustrates how the platform design based on marketing requirements, coupled with a properly constructed UEFI-compliant firmware, can greatly affect the performance characteristics of a platform. Some of the key points are:

- How specific marketing requirements affect boot performance.
- Suggestions on what firmware engineering choices can be made to optimize for a given platform requirement.
- Provide a realistic view of what performance enhancements can be done in a production firmware.
- Establish viable next steps.

This chapter focuses on specific aspects of a platform's pre-O/S boot behavior and leverages concepts that are based on the UEFI firmware architecture.

Some of the fundamental things that need to be understood are different phases of platform initialization and how they are exercised as part of the platform boot process. The following flow diagrams, Figure 15.1, 15.2, and 15.3, illustrate the evolution of the platform initialization from the first moment that power is applied until the point where the BIOS hands-off to the target O/S:

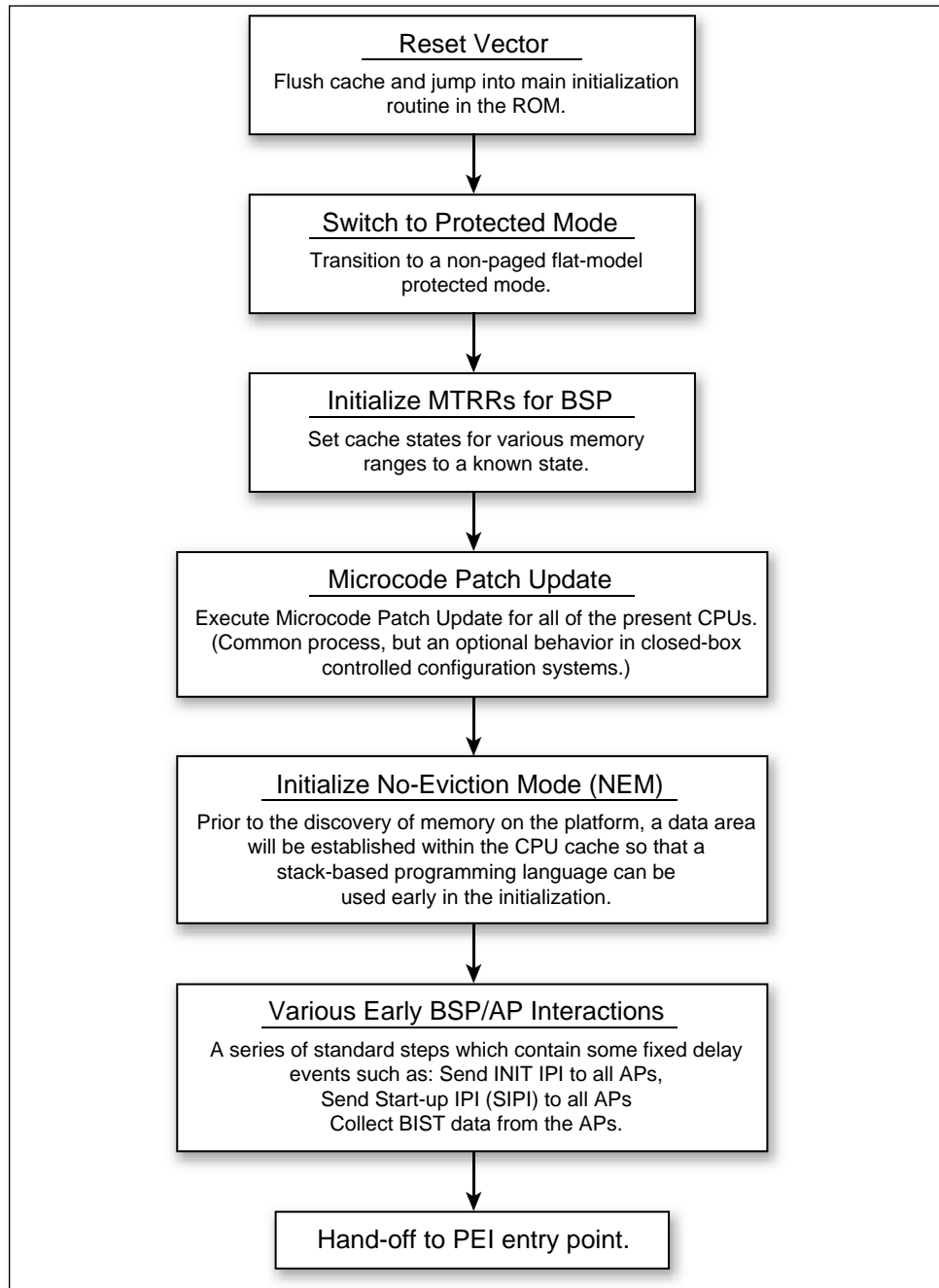
**Figure 15.1** SEC Phase

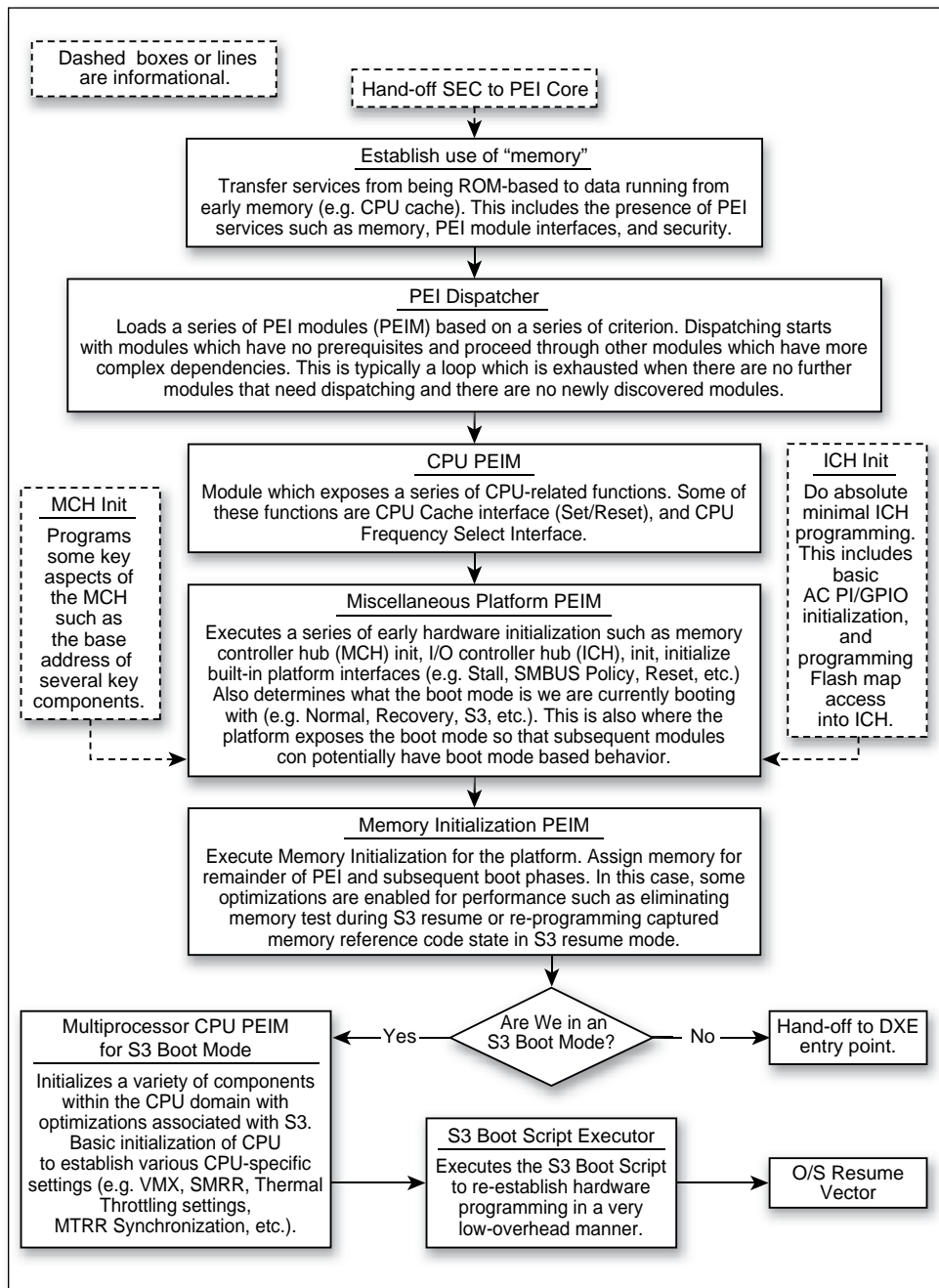

Figure 15.2 PEI Phase

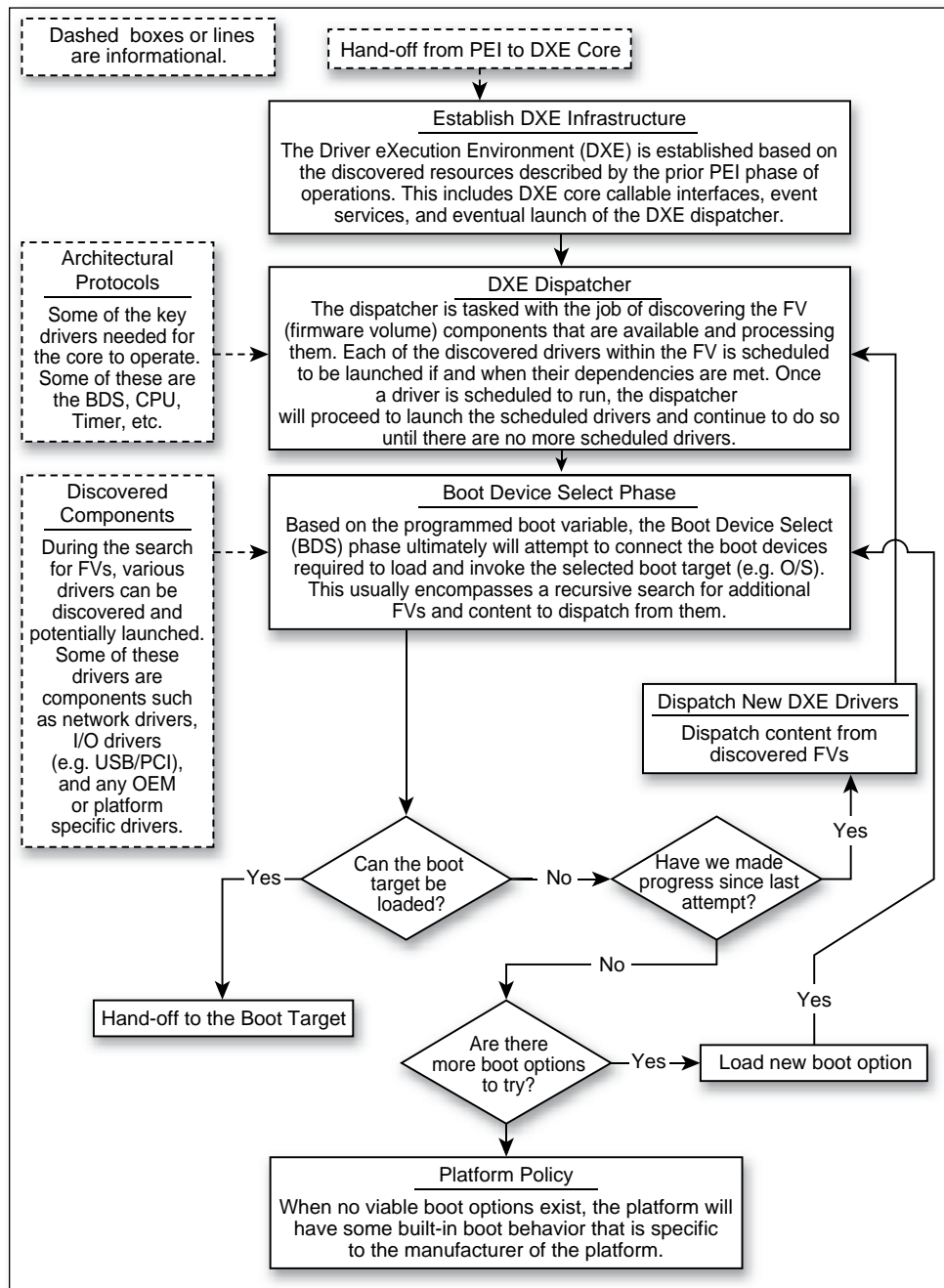

Figure 15.3 DXE and BDS Phase

Given the above information, the remainder of the chapter focuses on the important elements when considering how to best optimize some of the aforementioned behavior so a platform meets both its technical and marketing requirements yet achieves an optimal boot speed.

Proof of Concept

In the proof of concept for this chapter, the overall performance numbers used are measured in microseconds and the total boot time is described in seconds. Total boot time is measured as the time between the CPU first having power applied and the transferring of control to the boot target (which is typically the OS). This chapter does not focus on the specifics of the hardware design itself since the steps that are described are intended to be platform-agnostic. However, for those who absolutely must know from what type of platform some of the numbers are derived, they are:

- 1.8-GHz Intel® Atom™-based netbook design
- 1 GB DDR2 memory
- 2 MB flash
- Western Digital† 80-GB Scorpio Blue 5400-RPM drive (normal configuration)
- Intel® Solid State Drive X25-E (Intel® X25E SSD) (in optimized configuration)

It should also be noted that this proof of concept was intended to emulate real-world expectations of a BIOS, meaning that nothing was done to achieve results that could not reasonably be expected in a mass-market product design. The steps that were taken for this effort should be easily portable to other designs and should largely be codebase-independent.

Figure 15.4 shows the performance numbers achieved while maintaining all of the various platform/marketing requirements for this particular system.

SEC Phase Duration:	26342 (us)	SEC Phase Duration:	26419 (us)
PEI Phase Duration:	1230905 (us)	PEI Phase Duration:	763315 (us)
DXE Phase Duration:	998234 (us)	DXE Phase Duration:	443021 (us)
BDS Phase Duration:	7396050 (us)	BDS Phase Duration:	766778 (us)
Total Duration:	9.651531 (s)	Total Duration:	1.999533 (s)
Normal Boot		Optimized Boot	

Figure 15.4 Performance Measurement Results (Before/After)

The next several sections detail the various decisions that were made for this proof of concept and how they improved the boot performance.

Marketing Requirements

Admittedly, marketing requirements are not the first thing that comes to mind when an engineer sits down to optimize a BIOS's performance. However, the reality is that marketing requirements form the practical limits for how the technical solution can be adjusted.

The highlighted requirements are the pivot points in which an engineer can make decisions that ultimately affect performance characteristics of the system. Since this section details the engineering responses to marketing-oriented requirements, it does not provide a vast array of code optimization "tricks." Unless there is a serious set of implementation bugs in a given codebase, the majority of boot speed improvements are achieved from following the guidelines provided in this section. Not to worry though, there are codebase independent "tricks" included that provide additional help.

What Are the Design Goals?

How does the user need to use the platform? Is it a "closed box" system? Is it a traditional desktop? Is it a server? How the platform is thought of ultimately affects what the user expects. Making conscious design choices to either enable

or limit some of these expectations is where the platform policy can greatly affect the resulting performance characteristics.

Platform Policy

One of the first considerations when looking at a BIOS and the corresponding requirements are whether or not an engineer can limit the number of variables associated with what the user can do “to” the system. For instance, it might be reasonable to presume that in a platform with no add-in slots, a user will not be able to boot from a RAID controller since the user cannot physically plug one in.

This is where a designer enters the zone of platform policy. Even though a platform may not expose a slot, the platform might expose a USB connection. A conscious decision needs to be made for how and when these components are used. A good general performance optimization statement would be:

“If you can put off doing something in BIOS that the OS can do—then put it off!”

Since a user can connect anything from a record player to a RAID chassis via USB, the user might think that they would be able to boot from a USB-connected device if physically possible. Though this is physically possible, it is within the purview of the platform design to enable or disable such a behavior.

In this particular platform, the decision was made to not support booting from USB media and to not support the user interrupting the boot process. This means that during the DXE/BDS phase, the BIOS was able to avoid initializing the USB infrastructure to get keystrokes and this resulted in a savings of nearly 0.5 second in boot time.

Note	Even though 0.5 second of boot time was saved by eliminating late BIOS USB initialization, upon launching the platform OS, the OS was able to interact with plugged-in USB devices without a problem.
-------------	---

Platform policy ultimately affects how an engineer responds to the remaining questions.

What Are the Supported OS Targets?

Understanding the requirements of a particular platform-supported OS greatly affects what optimization paths can be taken in the BIOS. Since many “open” platforms (platforms without a fixed software or hardware configuration) have a wide variety of operating systems that they choose to support, this limits some of the choices available. In the case of the proof-of-concept platform, only two main operating systems were required to be supported. This enabled the author to make a few choices that allowed the codebase to save roughly 400 ms of boot time by avoiding the reading of some of the DIMM SPD data for creating certain SMBIOS records since they weren’t used by the target operating systems.

Note	Changes in the BIOS codebase that avoided the unnecessary creation of certain tables saved roughly 400 ms in the boot time.
-------------	---

Do We Have to Support Legacy Operating Systems?

The main consideration was whether a particular OS target was UEFI-compliant or not. If all the OS targets were UEFI-compliant, then the platform could have saved roughly 0.5 second in the underlying initialization of the video option ROM. In this case, we had conflicting requirements: one was UEFI-compliant and one was not. There are a variety of tricks that could have been achieved by the platform BIOS when booting the UEFI-compliant OS but for purposes of keeping fair measurement numbers, the overall boot speed numbers reflect the overhead of supporting legacy operating systems as well.

To save an additional 0.5 second or more of boot time when booting a UEFI-compliant OS, the BDS could analyze the target `BOOT####` variable to determine if the target were associated with an OS loader and thus it is a UEFI target. The platform in this case at least has the option to avoid some of the overhead associated with the legacy compatibility support infrastructure.

Do We Have to Support Legacy Option ROMs?

Whether or not to launch a legacy option ROM depends on several possible variables:

- Does the motherboard have any devices built in that have a legacy option ROM?
- Does the platform support adding a device that requires the launch of a legacy option ROM?
- If any of the first two are true, does the platform need to initialize the device associated with that option ROM?

One reason why launching legacy option ROMs is fraught with peril for boot performance is that there are no rules associated with what a legacy option ROM will do while it has control of the system. In some cases, the option ROM may be rather innocuous regarding boot performance, but not always. For example, the legacy option ROM could attempt to interact with the user during launch. This normally involves advertising a hot-key or two for the user to press, which would delay the BIOS in finishing its job for however long the option ROM pauses waiting for a keystroke.

For this particular situation, we avoided the launching of all of the drivers in a particular BIOS and instead opted to launch only the drivers necessary for reaching the boot target itself. Since the device we were booting from was a SATA device for which the BIOS had a native UEFI driver, there was no need to launch an option ROM. This action alone saved approximately three seconds on the platform. More details associated with this trick and others are in the section “Additional Details.”

Are We Required to Display an OEM Splash Screen?

This is often a crucial element for many platforms, especially from a marketing point of view. The display of the splash screen itself typically does not take that much time. Usually initializing the video device to enable such a display takes a sizable amount of time. On the proof-of-concept platform, it would typically take 300 ms. An important question is how long does marketing want the logo to be displayed? The answer to this question will focus on what is most important for the OEM delivering the platform. Sometimes speed is paramount (as it was with this proof of concept), and the splash screen can be eliminated completely. Other times, the display of the logo is deemed much more important and all things stop while the logo is displayed. An engineer’s hands are usually tied by the decisions of the marketing infrastructure.

One could leverage the UEFI event services to take advantage of the marketing-driven delay to accomplish other things, which effectively parallelizes some of the initialization.

What Type of Boot Media Is Supported?

In the proof of concept platform description, one element was a bit unusual. There was a performance and a standard configuration associated with the drive attached to the system. Though it may not be obvious, the choice of boot media can be a significant element in the boot time when you consider that some drives require 1–5 seconds (or much more) to spin up. The characteristics of the boot media are very important since, regardless of whatever else you might do to optimize the boot process, the platform still has to read from the boot media and there are some inherent tasks associated with doing that. Spin-up delays are one of those tasks that are unavoidable in today's rotating magnetic media.

For the proof of concept, the boot media of choice was one which incurs no spin-up penalty; thus a solid state drive (SSD) was chosen. This saved about two seconds from the boot time.

What Is the BIOS Recovery/Update Strategy?

How a platform handles a BIOS update or recovery can affect the performance of a platform. Since this task may be accomplished in many ways, this may inevitably be one of those mechanisms that has significant platform variability. There are a few very common ways a BIOS update is achieved from a user's perspective:

- A user executes an OS application, which they likely downloaded from the OEM's Web site. This will eventually cause the machine to reboot.
- A user downloads a special file from an OEM's Web site and puts it on a USB dongle and reboots the platform with the USB dongle connected.

- A user receives or creates a CD or floppy with a special file and reboots the platform to launch the BIOS update utility contained within that special file.

These user scenarios usually resolve into the BIOS, during the initialization caused by the reboot, reading the update/recovery file from a particular location. Where that update/recovery file is stored and when it is processed is really what affects performance.

When Processing Things Early

Frequently during recovery one cannot presume that the target OS is working. For a reasonable platform design, someone would need to design a means by which to update or recover the BIOS without the assistance of the OS. This would lead to user scenarios #2 or #3 listed above.

The question an engineer should ask themselves is, how do you notify the BIOS that the platform is in recovery mode? Depending on what the platform policy prescribes, this method can vary greatly. One option is to always probe a given set of possible data repositories (such as USB media, a CD, or maybe even the network) for recovery content. The act of always probing is typically a time-consuming effort and not conducive to quick boot times.

There is definitely the option of having a platform-specific action, which is easy and quick to probe that “turns on” the recovery mode. How to turn on the recovery mode (if such a concept exists for the platform) is very platform-specific. Examples of this are holding down a particular key (maybe associated with a GPIO), flipping a switch (equivalent of moving a jumper), which can be probed for, and so on. These methods are highly preferable since they allow a platform to run without much burden (no extensive probing for update/recovery.)

Is There a Need for Pre-OS User Interaction?

Normally the overall goal is to boot the target OS as quickly as possible and the only expected user interaction is with the OS. That being said, the main reason for people today to interact with the BIOS is to launch the BIOS setup. Admittedly, some settings are within this environment that are unique and cannot be properly configured outside of the BIOS. However at least one major OEM (if not more) has chosen to ship millions of UEFI-based units without exposing what is considered a BIOS setup. It might be reasonable to

presume for some platforms that the established factory default settings are sufficient and require no user adjustments. Most OEMs do not go this route. However, it is certainly possible for an OEM to expose “applets” within the OS to provide some of the configurability that would have otherwise been exposed in the pre-OS timeframe.

With the advent of UEFI 2.1, and more specifically the HII (Human Interface Infrastructure) content in that specification, the ability for configuration data in the BIOS to be exposed to the OS was made possible. This makes it possible for many of the BIOS settings to have methods exposed and configured in what are not traditional (pre-OS) ways.

If it is deemed unnecessary to interact with the BIOS, there is very little reason (except as noted in prior sections) for the BIOS to probe for a hot key. This only takes time from a platform boot without being a useful feature of the platform.

Additional Details

When it comes time to address some codebase issues, the marketing requirements clearly define the problem space an engineer has to design around. With that information, several methods can help that are fairly typical of a UEFI-based platform. These are not the only methods, but they are the ones that most any UEFI codebase can use.

Adjusting the BIOS to Avoid Unnecessary Drivers

It is useful to understand the details of how we avoided executing some of the extra drivers in our platform. It is also useful to reference the appropriate sections in the UEFI specification to better understand some of the underlying parts that cannot, for conciseness, be covered in this chapter.

The BDS phase of operations is where various decisions are made regarding what gets launched and what platform policy is enacted. That being said, this is the code (regardless of which UEFI codebase you use) that will frequently get the most attention in the optimizations. If we refer again to the boot times for our proof of concept, it should be noted that the BDS phase was where the majority of time was reduced. Most of the reduction had to do with optimizations as well as some of the design choices that were made and the phase of initialization where that activity often takes place.

At its simplest, the BDS phase is the means by which the BIOS completes any required hardware initialization so that it can launch the boot target. At its most complex, you can add a series of platform-specific, extensive, value-added hardware initialization that is not required for launching the boot target.

What Is the Boot Target?

The boot target is defined by something known as an EFI device path (see UEFI specification). This device path is a binary description of where the required boot target is physically located. This gives the BIOS sufficient information to understand what components of the platform need to be initialized to launch the boot target.

Below is an example of just such a boot target:

```
Acpi (PNP0A03,0) /Pci (1F|1) /Ata (Primary,Master) /  
HD (Part3, Sig00110011) /"\EFI\Boot"\OSLoader.efi"
```

Steps Taken in a Normal and Optimized Boot

Figure 15.5 indicates that between the non-optimized boot and an optimized boot, there are no design differences from a UEFI architecture point of view. In addition, Figure 15.6 shows how significantly the behavior of the platform might be in each of the contrasting scenarios, however optimizing a platform's boot performance does not mean that one has to violate any of the design specifications.

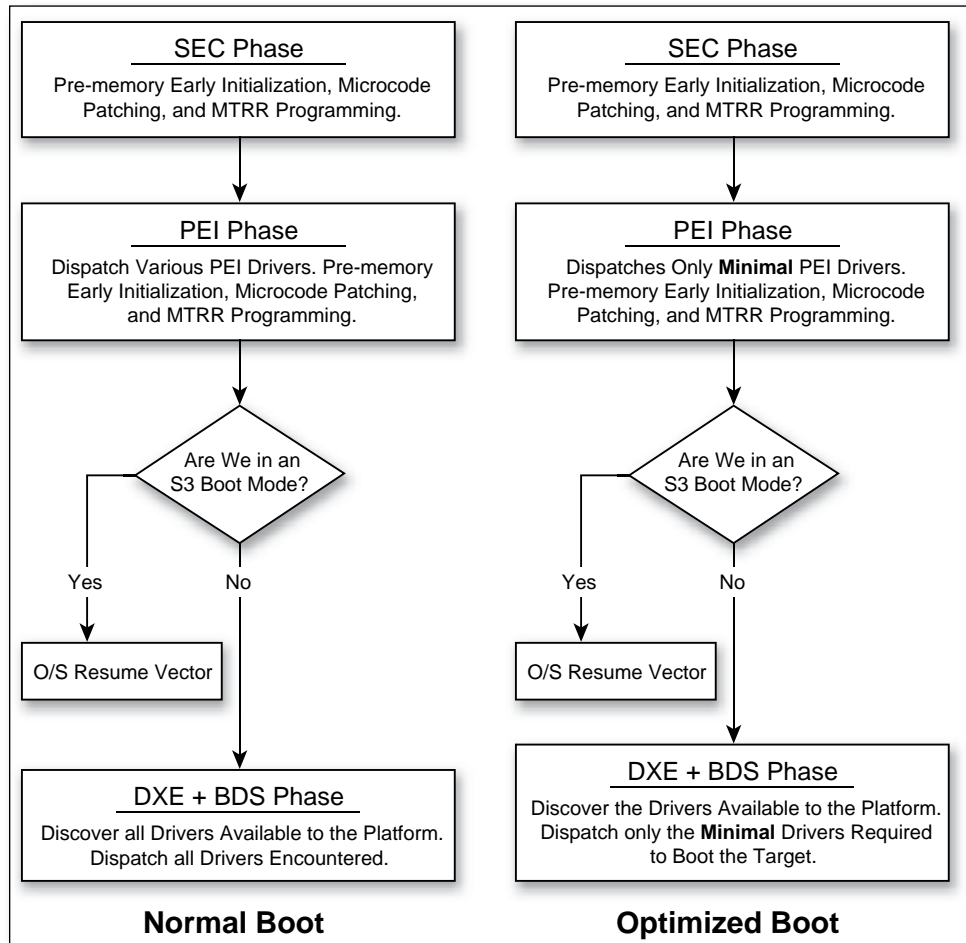

Figure 15.5 Architectural Boot Flow Comparison

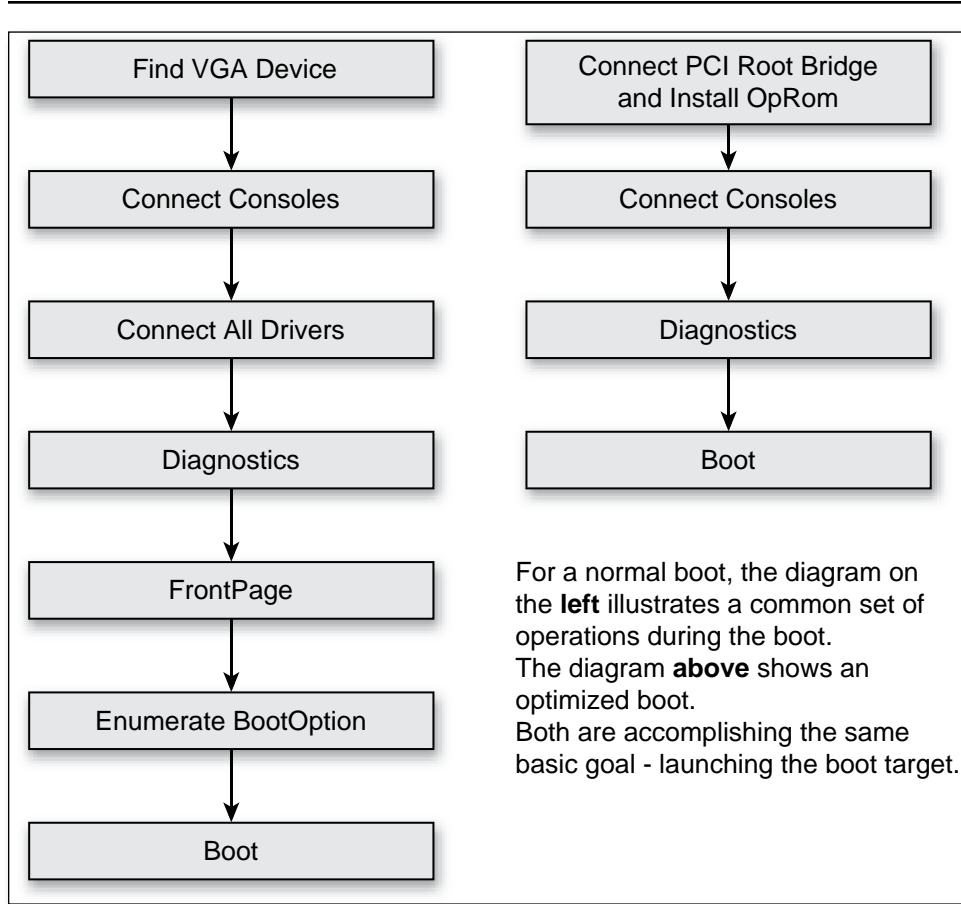

Figure 15.6 Functional Boot Flow Comparison

Loading a Boot Target

The logic associated with the BDS optimization focuses solely on what is the minimal behavior associated with initializing the platform and launching the OS loader. When customizing the platform BDS, you can avoid calling routines that attempt to connect all drivers to all devices recursively, such as `BdsConnectAll()`, and instead only connect the devices directly associated with the boot target. Figure 15.7 illustrates an example of that logic.

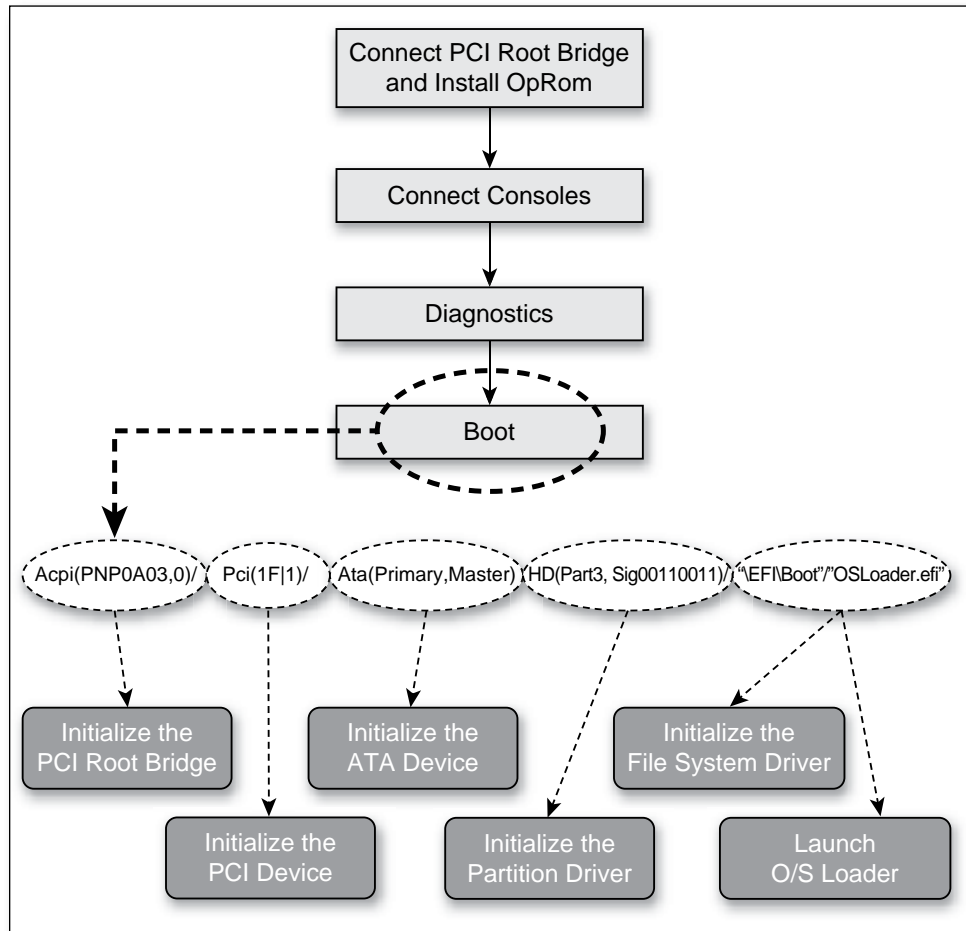

Figure 15.7 Deconstructing the BDS launch of the Boot Target

Organizing the Flash Effectively

In a BIOS that complies with the PI specification, there is a flash component concept known as a firmware volume (FV). This is typically an accumulation of BIOS drivers. It would be reasonable to expect that these FVs are organized into several logical collections that may or may not be associated with their phase of operations or functions. There are two major actions that the core initiates associated with drivers. The first one is when a driver is dispatched

(loaded into memory from flash), and the second one is when a driver is connected to a device. Platform policy could dictate that the DXE core avoids finding unnecessary drivers. For instance, if the USB device boot is not needed, the USB-related drivers could be segregated to a specific FV, and material associated with that FV would not be dispatched.

Minimize the Files Needed

Since one of the slowest I/O resources in a platform is normally the flash part on which the BIOS is stored, it is a very prudent idea to minimize the amount of space that a BIOS occupies. The less space a BIOS occupies, the shorter the time is for routines within the BIOS to read content into faster areas of the platform (such as memory). This can be done by minimizing the drivers that are required by the platform, and pruning can typically be accomplished by a proper study of the marketing requirements.

Summary

Ultimately, the level of performance optimization that is achievable is largely subject to the requirements of the platform. Given sufficient probing, there are almost always methods to achieve boot speed gains using some of the techniques highlighted in this chapter. Here are some of the highlights of items to focus on and areas within each BIOS codebase that deserve further investigation.

The Primary Adjustments

Based on various conditions in a platform, the boot behavior can be adjusted to speed up the boot process. Much of this occurs in the BDS, but some areas of optimization may vary per each individual codebase.

- Focus on the marketing requirements
 - Based on the marketing requirements, many decisions that affect boot performance can be made. Open dialog between marketing and engineering helps with this.
- Minimize the use of slow media

- Scanning for firmware component in a flash device can be very slow. Optimize routines that touch slow media.
- No need to poll for setup pages or even initialize a console in some cases.
 - Polling for keys or user interaction can be minimized in the BDS.
- Not all hardware needs to be initialized. Often only the hardware directly associated with the valid boot target needs to be initialized.
- Tweaks
 - Only initiate activity that the BIOS must do; the OS is often going to repeat what the BIOS just did.
 - If no hardware changes are detected there is no need to re-enumerate various subcomponents.
 - It may not be a need to probe boot options if we cache the last known valid boot option.

Suggested Next Steps

Some common procedures can be applied to all platforms:

- Make full use of platform cache
 - Especially in PEI phase where the code is XIP (eXecute-In-Place), caching the flash region can contribute significantly to code fetch and execution improvements.
- Minimize the use of slow media
 - Scanning for a firmware component in a flash device can be very slow. Optimize routines that touch slow media. For instance, the variable region is normally stored in flash and it is very time-consuming to traverse the whole flash region for each variable search. It would be a reasonable optimization to use memory-based cache to store the whole variable region or just the variable index to speed up the variable search time.

- Analyze drivers that spend time blocking the boot progress. More often than not, these drivers can gain improvements in performance with minor adjustments.
 - If hard disk spin-up time is a blocking factor in the platform boot times, the BIOS owner could adjust some of the logic to initiate the disk spin-up in an earlier stage of the boot logic to mitigate some of this slow-down and avoid a blocking behavior. Using an EFI event for such an optimization may be very reasonable.
- First focus optimization work on the components that the BIOS spends the most time on. Usually more optimization results can be achieved in these components.

Chapter 16

Embedded Boot Solution

Unless you try to do something beyond what you have already mastered, you will never grow.

—Ralph Waldo Emerson

The expected market segment opportunity beyond 2012 for embedded systems will be over USD 10 billion. Some examples of this focused segment, as shown in Figure 16.1, include: in-vehicle infotainment (IVI) for automotive use, print imaging (enterprise printing solutions), industrial control, residential or premise service gateways (PSG), home control, media phones (MPs), set top boxes, mobile Internet devices (MIDs) and physical security/digital security and surveillance (video analytics systems and IP cameras).

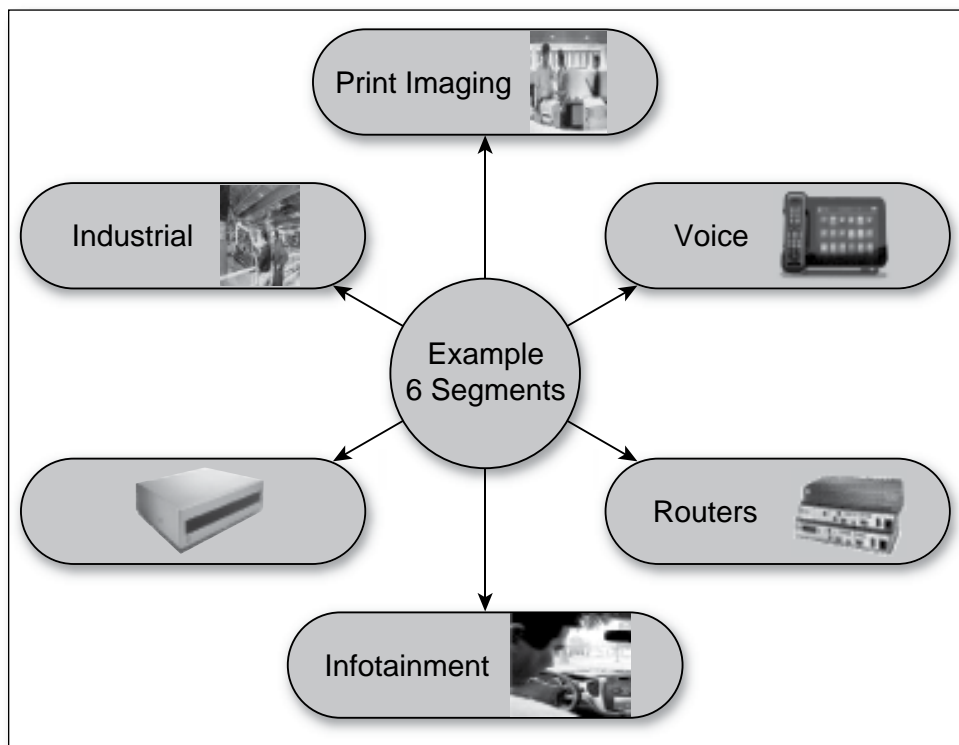

Figure 16.1 Embedded Usage Examples

This chapter describes the boot firmware challenges and solutions for these market segments. The primary focus is to cover the platform boot solution, which includes standard PC BIOS, bootloaders (also known as steploaders), initial program loaders (IPLs, also known as second-stage bootloaders), and OS boot driver components for running a shrinkwrap and/or industry standard embedded OS.

CE Device Landscape

The Intel® Atom™ processor family of low power embedded processors are making their way into many lower power platforms, the key being MIDs (mobile Internet devices), netbooks and a variety of embedded markets as enumerated above. Some of these segments are targeted towards consumers, following the Consumer Electronics (CE) device model paradigm. One of the

key attributes of a CE device is the positive end-user experience, which is of paramount importance. The user experience is based on such factors as:

- Battery life/low thermal dissipation for fanless device operation
- Small device form factor/footprint for portability
- Ease of use
- Low bill of material (BOM) resulting in lower end-user cost
- Interoperability with other CE devices
- The time between power-on and the user interface becoming active, also known as boot latency to user interface/human machine interface (UI/HMI)

CE Device Boot Challenges

Traditional CE devices from OEMs were fully customized solutions with OEM specific hardware and software components that were uniquely tuned for a particular use model such as smart phones or MIDs. In this case, custom platforms were developed top-down from scratch for pre-determined usage models with customized applications, middleware, device drivers, OS, system boot firmware and tightly coupled companion boot devices/hardware. With each new platform development, the software solution had to be recreated.

The use of Intel® architecture would help reduce this re-development, reducing time to market and cost. One of the value propositions and advantages of using both Intel architecture based processor family System on a Chip (SoC) solutions and platforms is the wide availability of standard platform building blocks from Intel and external ecosystem suppliers providing hardware, software, BIOS, applications, development tools and so on.

As many of these platform building blocks migrated from a standard PC to embedded SoC segments, they posed some interesting challenges to directly map to the top-down CE device use model. It takes optimization of more than a dozen system hardware and software components across the system stack to achieve the desired CE goals, with the boot firmware being a key component

of it. Figure 16.2 identifies some of the components in the boot path that contribute to the overall system boot latency as needed for the CE devices.

The following is a short list of some key components that contribute to the overall boot latency to UI active time.

- Platform power sequencing latencies, such as stabilization of PLL/Clocks, voltage regulators, and power rails
- Speed of bus interface to boot device, such as Serial Peripheral Interface (SPI) and Low Pin Count (LPC)
- Access latency of storage device for firmware, such as NOR/NAND Flash
- Access latency of mass storage device, such as HDD, SSD, MMC/SD
- Splash screen latency
- Latencies associated with boot firmware or bootloader execution
- Initial program load latencies, such as second stage OS boot loader (also known as IPL)
- Partitioning of the firmware and OS boot components across the storage device, such as NOR, SDD, HD, and MMC
- Use of file system type for storing the boot image, such as ROM, FAT, and EXT3
- Latency of graphics and audio device startup if required

Figure 16.2 shows various boot components across the system stack that need to be optimized and aligned to get to the end goal of low boot latency as desired by a CE device user. Moreover, many of these components have interdependencies for them to function effectively. For example: the fast splash screen needs to provide a seamless handoff to the graphics driver, and the block storage device must power-on early in firmware before a handoff to IPL.

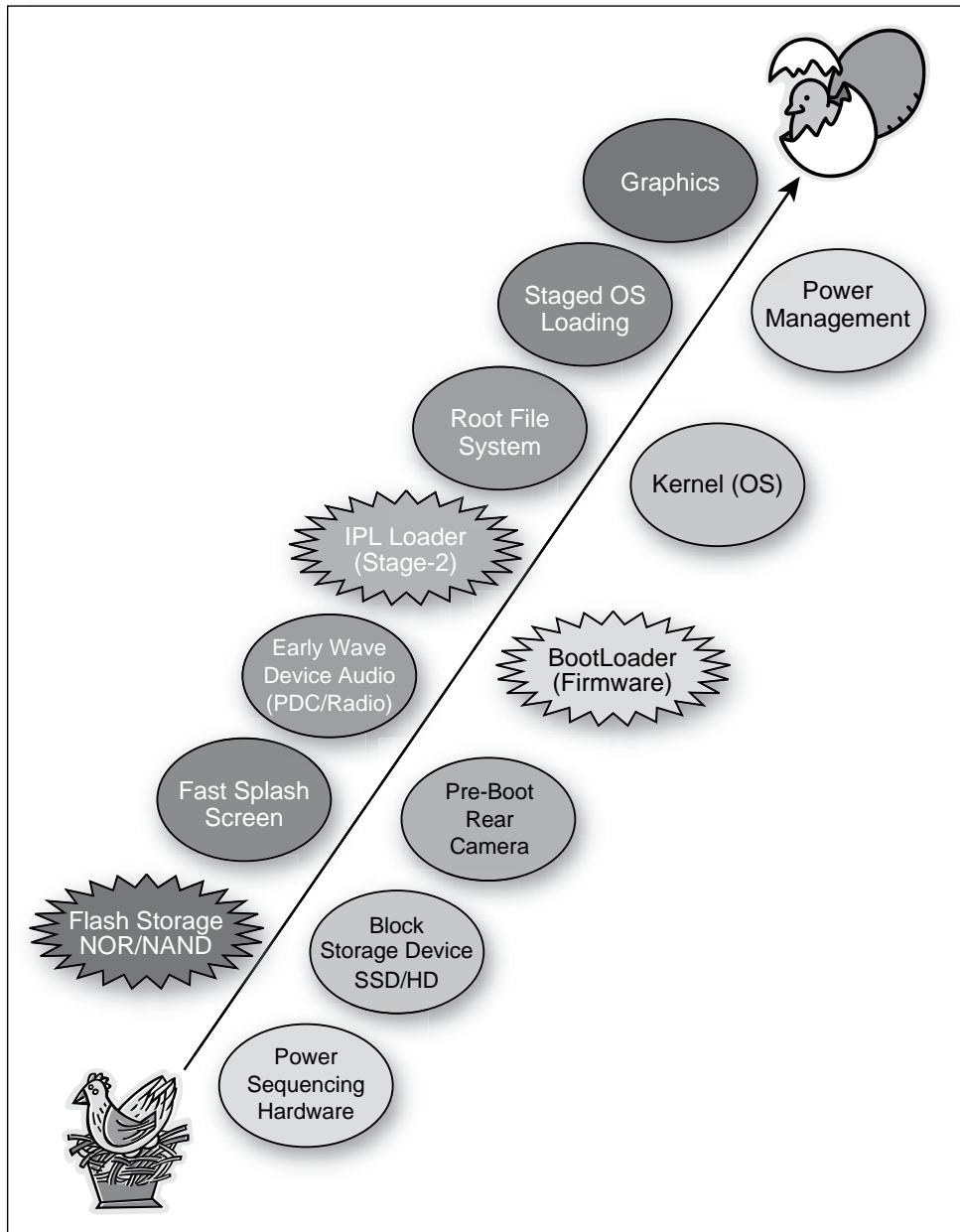

Figure 16.2 End-to-End Boot Latency Dependency Components

A case study of one of the CE device usages for IVI with typical boot requirements follows. The fast boot requirements for most other CE segments are considered to be a subset of IVI, which has the most stringent requirements of all.

In-Vehicle Infotainment

An IVI user expects an instant power-on experience, similar to that of most consumer appliances like TVs. To meet this same expectation, one of the key requirements of the IVI platform is the sub-second cold boot time, which helps facilitate the user experience when the ignition key/button is turned on. The typical boot latency requirements are as illustrated in Figure 16.3.

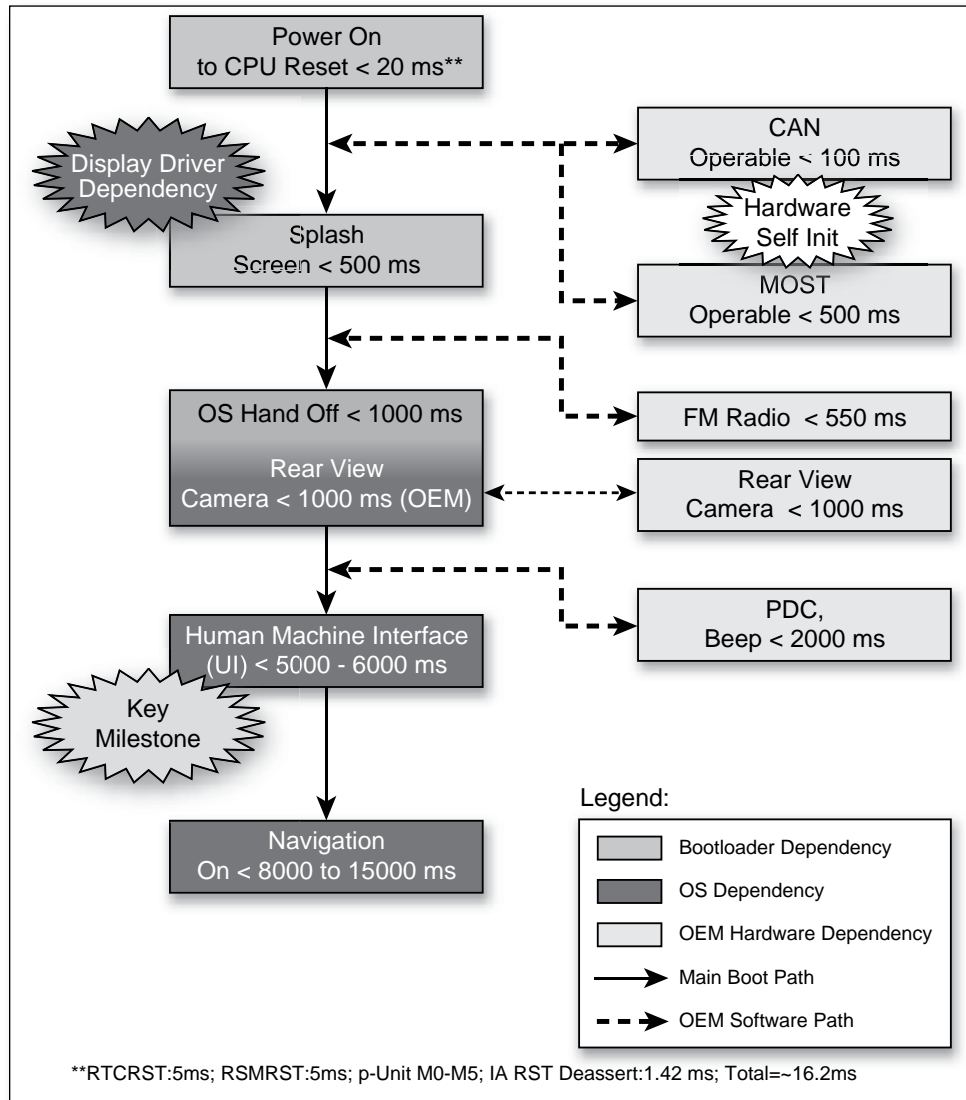

Figure 16.3 Typical CE Device Boot Latency Requirements

Within the requirements highlighted above, there are multiple key latency checkpoints where the boot firmware plays a key role. These include:

- *Power-on to splash screen active.* The time between hardware power-on and splash screen active is key because it helps improve the user

perception with an early audio/visual experience. This is accomplished by displaying a static image bitmap or a logo on the display device. The pre-OS boot environment is where this typically gets activated, immediately after the memory initialization is done. Several of the initialization functions are needed to enable the display to occur in parallel while the boot firmware is busy performing its other unrelated boot functions in the background, such as memory and chipset initialization. Once the splash screen is enabled, the firmware typically does a handshake with the OS environment for a seamless handoff of the splash screen display status and related information, such as frame buffer physical address and display mode. If the firmware can hand-off to the OS in less than 50–100 ms, it is possible to leave this function for the OS to enable, thereby making it a post-OS boot feature.

- *Power-on to rear view camera active.* This is another operation that may have to get activated in the background and be presented to the user with a motion image from the rear view camera. This function is typically used when backing up an automobile and the function needs to be activated upon entering reverse (“R” gear). In some use cases, video from an embedded camera may be preferred in place of a static splash screen image. The initialization and activation of the camera interface can be done in parallel with bootloader flows through hardware state machine assist. The event generation and notification mechanism (“R”) also need to be enabled early on in the boot sequence.
- *Power-on to the boot storage device active.* The time between these functions impacts the speed at which the OS can be shadowed and launched by the Initial Program Load. This is typically done in the early firmware boot sequence as part of the chipset initialization, to hide the boot device ready latency such as hard disk spin-up, eMMC/SD device ready, and so on.
- *Power-on to OS handoff (IPL).* This function is done in the background and is a measure of overall firmware latency of the boot firmware. All actions beyond this fall into the OS boot domain for a typical bootloader.

- *OEM-specific functions.* Other OEM device-specific functions such as Controller Area Network (CAN)/Media Oriented Systems Transport (MOST) interface activation, FM radio activation, and TPM measured boot, are orthogonal to the core platform functions and are managed by OEM-specific hardware/firmware. Typically the events from CAN and data over MOST can be used as trigger events for operation of functions such as rear view camera activation.

All other boot latency checkpoints illustrated are outside the scope of the boot firmware and have a dependency on the kernel components and device drivers that are associated with the key boot devices: storage (such as NAND), audio, graphics, video, and so on.

Other Embedded Platforms

As noted above, IVI is just one of the many embedded segments with rapid boot time requirements. The interesting thing to note is that when all the segments are taken into consideration, the fundamental common denominator across all of them is the boot firmware, that needs to work with a variety of operating systems including Fedora Linux[†], QNX[†], Microsoft XP Embedded[†], Microsoft WinCE[†], WindRiver Automotive Grade Linux[†], Microsoft Automotive[†] (based on Win CE), WindRiver VxWorks[†], Microsoft Windows XP[†], Microsoft Vista Embedded[†], 4690/DOS[†], MeeGo[†], SuSe[†], Microsoft Windows for Point-of-Sales (WEPOS) [†], Win7e[†], and Win8.

For a typical CE platform, the boot firmware must support interoperability with multiple types of OS IPLs as follows:

- ACPI-compliant UEFI BIOS with a UEFI OS IPL (such as eLilo): this is typically used with aftermarket products that may run an embedded version of a shrinkwrap OS such as Standard Embedded Linux or Window XPe that requires PC compatibility and is readily available from the BIOS vendors or original device manufacturers (ODM).
- Embedded OS IPL: this solution is meant to work with an OS that does not rely on the PC BIOS compatibility such as an embedded OS and some variants of Linux. This approach requires specialized IPL that is customized for the platform topology and the nonstandard

secondary storage device such as managed NAND (also known as an eMMC device).

Note	Reducing the bill of material cost of a CE platform is quite critical, hence consolidating the SPI Flash (NOR) and NAND storage to one device like eMMC is beneficial. However, this comes with some challenges for Intel boot architecture and the firmware flow that depends on various aspects such as execute in place ROM (XIP), secure and write-protected regions offered by SPI flash controllers, and so on.
-------------	---

Generic Requirements

Traditional platforms typically have boot latencies to UI active times that average 10–40 seconds. Getting this UI active latency down to below 5–6 seconds, with an active splash screen in less than 500 ms is a big challenge. To reduce time to market and product development costs, it is highly desired to develop one boot firmware and OS solution that can scale across different CE device platforms from each of the OEMs with varying topologies, but based on the same SoC core. Many optimizations were done to both the BIOS and bootloader solutions to fit into the IVI platform and the same can be easily extended to any CE device. The key being the reordering and early initialization of user-visible I/O like display activation, initial program load (IPL) boot menus, enabling processor cache usage at boot as high speed RAM (CAR), and so on.

The basic or generic bootloader for any CE device model requires the following attributes:

- *Low Boot Latency.* The generic boot requirements for a CE device can be summarized as: power-on to OS handoff in less than one second and splash screen in less than 500 ms.
- *Footprint.* The firmware code size needs to be small, reusable, and portable across all platforms using the same SoC without modifications, such as a size of less than 384 KB.

- *Reliability.* The bootloader must provide interoperability across a variety of operating systems, including shrinkwrap, embedded real-time operating systems, and so on.
- *Cost optimization.* The solution must minimize the platform bill of material cost through consolidation of multiple storage devices like SPI Flash and Secure Digital Input Output (SDIO) managed NAND.
- *Lifecycle.* The bootloader should have a typical lifecycle of 5 years.

Figure 16.4 illustrates the common initialization flows encountered in a typical platform initialization.

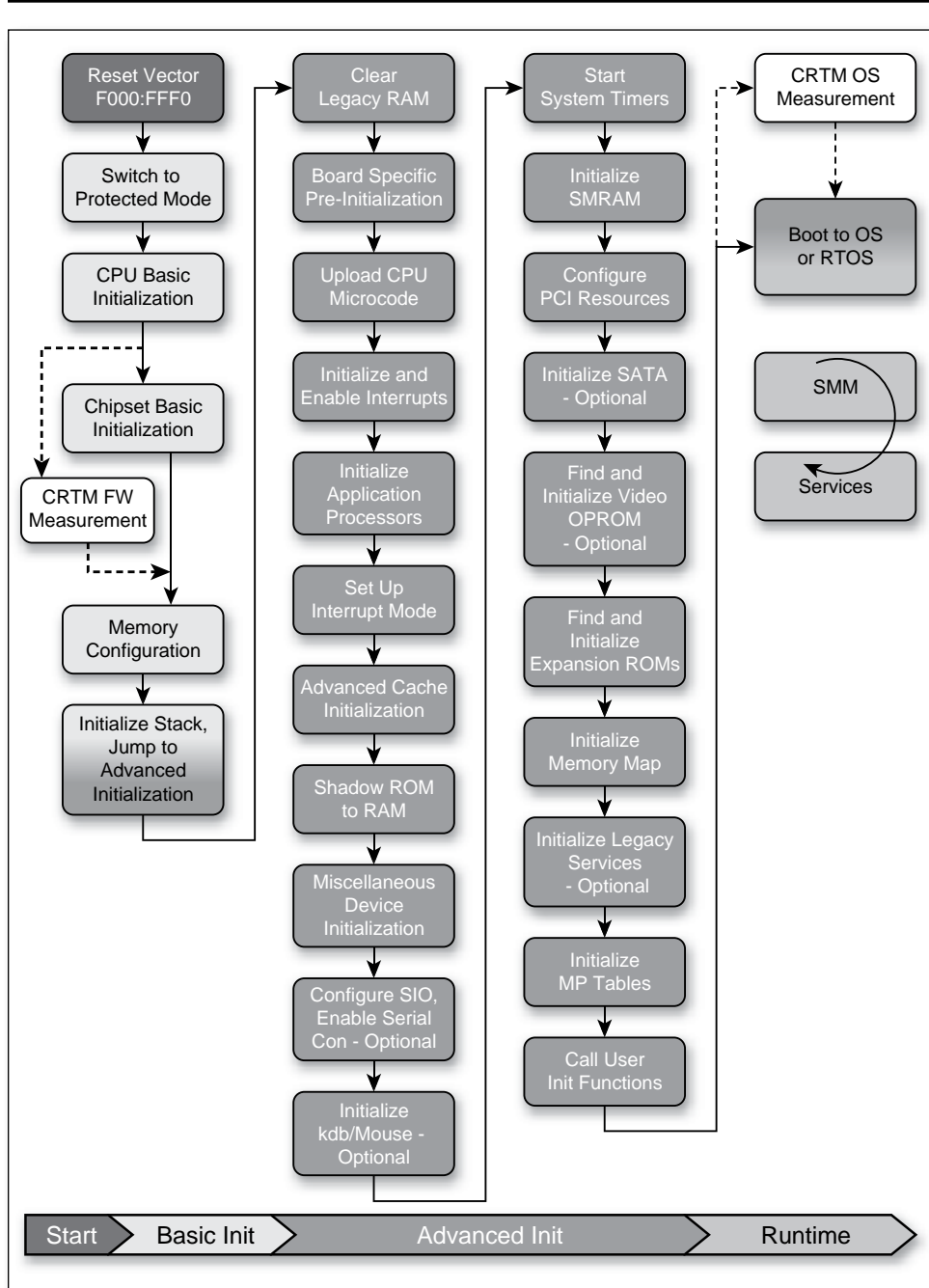

Figure 16.4 Typical Intel® Architecture CE Device Firmware Boot Flow

Boot Strategies

To fit most of the usage models described above, different CE device boot strategies are adopted, namely Fixed Topology Systems, Binary Modules model and Simplified bootloader, as described below:

- *Fixed Topology Systems.* This strategy uses standard ACPI-compliant UEFI BIOS with a fixed platform topology and a compliant IPL, such as eLilo. This is typically used with aftermarket products that may run an embedded version of a shrinkwrap OS, but with varying I/O devices that are chosen by the end customer (such as Standard Embedded Linux or Window XPe). The BIOS is required to provide PC compatibility and is readily available from the independent BIOS vendors (IBV) or Original Device Manufacturers (ODM). This solution provides the most flexibility for seamless addition of I/O for each of the OEM machine topologies, but at the expense of higher boot latencies. Many of the initialization sequences in the boot path are optimized to reduce the latencies significantly in the order of 5–10 seconds. Some of the noncritical PC BIOS functions such as PCIe device enumeration, OptionROM scanning, memory testing, POST, and video BIOS usage may be eliminated or simplified during the boot sequence. Disabling of these and other functions help reduce the boot latencies significantly. Refer to the white paper on one such implementation and the optimizations done for it:

<http://download.intel.com/design/intarch/papers/320497.pdf>

- *Binary Modules with Configuration.* This is the most highly optimized solution for the CE platform for low boot latencies and is tightly coupled to the functions on the SoC. Since the functions of the SoC do not change across different OEM implementations, one single firmware image compiled from a set of object libraries would suffice to boot all platforms built around the SoC. The OEM may use a development kit, which would allow customization facilitated through a set of exposed application programming interfaces (APIs) in the objects. These object APIs could perform basic and advanced initialization and control tasks like the following:

- Processor initialization (including multiprocessor support, cache configuration, and control)

- Chipset and memory initialization
- Core libraries for I/O initialization such as PCI resource allocation, and IDE HD initialization
- Flash Storage (NOR, NAND), Super I/O support
- Pre-boot graphics (splash screen) support where available

This solution is primarily meant to work with an OS, which does not rely on the PC BIOS compatibility, such as an embedded OS and some variants of Linux. The boot latencies achieved are deterministically optimized for a fixed CE device model built around the same SoC. The goal of this approach is to allow the OS to enable other standard non-boot and OEM-specific I/O device enabling through the use of loadable device drivers in the OS. Refer to the white paper on one such approach and the optimizations done for it:

<http://download.intel.com/design/intarch/papers/323246.pdf>

- *Simplified Bootloader.* This is the third category of firmware bootloader that has a subset of functionality of the above two mechanisms. In this type of implementation, the bootloader firmware consists of the basic initialization functionality of the CPU, flash, and the DRAM subsystem. The subsequent portion of chipset hardware and I/O device initialization is left for the OS hardware abstraction layer (HAL) to deal with, essentially moving much of the firmware platform initialization function to the OS. This gives the OS more control to optimize the boot latencies by allowing it to touch or initialize devices on a demand basis, thereby eliminating the latency associated with non-boot related platform device initialization. The major disadvantage of this approach is that for every new SoC and platform topology, the HAL component for each OS needs to be rewritten and this is a major undertaking.

Power Management

Traditional Intel architecture platforms support various power management capabilities to conserve power of battery powered devices and to reduce thermal dissipation for AC powered devices. The CE device will leverage from the same power states as defined in the ACPI specification (Sx) and (Dx), but with or without ACPI support in the firmware. A simplified ACPI table or its equivalent, with a capability to communicate standby (S3) state wake-up vector information between the OS and the firmware is the minimum requirement for this usage model.

As highlighted earlier, one of the key design goals of the CE device is a fast boot in the order of seconds. Typically, any resumption from Suspend/Hibernate back to active state involves restoring the previous state. In certain CE device use cases, the Resume from Sleep (suspend to RAM) could be used for sub-second fast boot purposes. However, Sleep mode is undesirable for some CE device use cases like IVI, due to the battery drain from DRAM leakage current in an extended park scenario or a need to avoid inadvertently restoring one user context for another for a rental car scenario. This makes the fast cold boot with a completely fresh state on every power-on a key requirement for the CE device architecture.

Boot Storage Devices

Another factor that plays a significant role in helping reduce the overall boot latency is the choice of the boot storage device and the system interconnect to it, such as LPC and IDE.

Firmware is typically stored on a flash device, which can take the form of NOR, Raw NAND or Managed NAND (MMC-NAND). Each of these is connected through different system interfaces like LPC/SPI, Open NAND Flash Interface (ONFI), or SDIO. Depending on the combination of the bus interface and storage device used, the read throughputs can vary anywhere from 1.5 MB/s to 52 MB/s at the time of writing of this book. It is to be noted that to satisfy the Intel architecture platform boot sequence and legacy compatibility, XIP flash (NOR) is best. NAND is a block storage device and does not lend itself very well as the XIP memory. The mitigation to overcome this NAND limitation is to use SRAM caches in the path to the processor or the NAND accesses redirected in hardware to DRAM, where the firmware

is shadowed ahead of time. The look-ahead shadowing of NAND content to DRAM does introduce additional latencies in the boot path.

In the case of software partitioning, an IPL which is part of the OS and includes the kernel may be stored on a secondary block storage device, such as a hard disk (HD), solid state drive (SSD) or a managed/unmanaged NAND. There are spin-up times associated with HD and power-on to device ready latencies associated with SSD/NAND and these contribute to the boot latencies as well.

To help keep the platform BOM cost low, it is highly desirable to consolidate the storage device used for the boot firmware, OS, and user applications/data. While NOR flash does offer some speed advantages, the NAND flash offers both a cost and performance advantage that is well balanced. The latest managed NAND version based on the MMC 4.4 specification offers quite a few capabilities to allow the unified storage use case, such as boot block for firmware storage, user Storage, and security features. It is quite possible to achieve this unified boot storage CE device use model with some changes in the Intel architecture platform hardware and firmware flows. This is as illustrated in Figure 16.5.

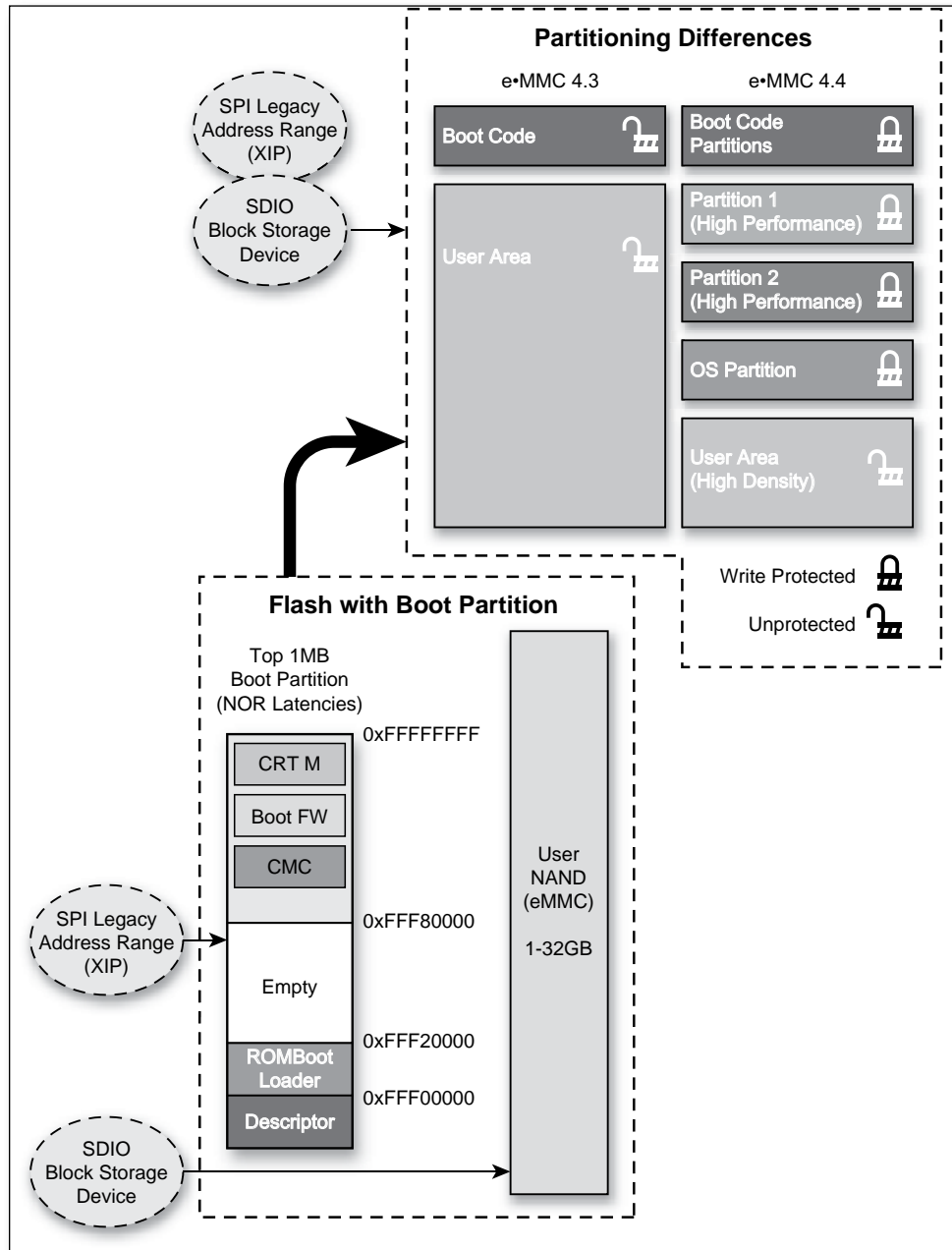

Figure 16.5 Typical Intel® Architecture Storage Device Consolidation Model

Security

Different embedded segments have varying security requirements collectively categorized as Security. These security requirements apply to two different usage models, which are orthogonal to each other:

- Security as it relates to platform defense against attacks from hackers and malware.
- Security as it relates to encryption/decryption of network packets (example: IPSec/SSL, Voice SRTP).

SoC based embedded platforms are targeted to support “open and closed device” usage models. This means that the user will be able to download and install any native application on the device. This puts these devices on par with the standard PC as far as threats from viruses and malware are concerned. This is where the security for defense against attacks becomes a key platform feature, with the boot firmware playing a key role in establishing a chain of trust.

Since the CE platforms are targeted to support “open and closed device” usage models, it requires special attention for two key aspects of security. First, the system must have a tamper-resistant software environment to protect against malicious attacks and second, it must offer the ability to playback DRM protected content such as Blu-ray[†] without being compromised. Table 16.1 shows the usage and threat model of a typical CE device.

Table 16.1 Usage Model and Security Threats

CE Usage Model	Threats
Internet Connectivity	Malware attack, DoS Attacks, packet replay/reuse, etc.
Secure Internet Transaction	Steal privacy sensitive data
DRM Content Usage	Steal DRM protected content
Browser Usage	Malware attack, phishing
Software Downloads/Updates	Change OS/software stack
Device Management	DoS attack, Illegal device connections
ID Management	Dictionary attacks, stolen privacy data
One Time Provisioning	Steal OEM data, unauthorized activation
Full Featured OS	All of the above
Biometrics (Finger print sensor)	Steal user data, authentication credentials

Based on the usage model described in Table 16.1, the assets on the platform that need to be protected from a hacker are as follows:

- Platform resources including: CPU, memory, and network (3G, WiMax, Wi-Fi)
- Privacy sensitive data including: ID, address book, location, e-mails, DRM protected copyrighted content such as music and video
- Trusted services including: financial, device management and provisioning, trusted kernel components

Based on the techniques needed for threat mitigation, one of the fundamental mechanisms to achieve security is to make the software tamper-resistant (TRS). TRS goal is achieved by having platform and software mechanisms in place to check for software integrity, both at system boot and runtime. The high level overview of this is as follows:

- *Boot Time.* This is typically accomplished through a mechanism called *measured boot*, where the core platform software components (firmware or OS) are checked for unauthorized changes.
- *Runtime.* This runtime security protection is typically achieved by having software agents monitoring the system against attacks (for example, anti-virus software) and also by securing through application sandboxing, which restricts the application accesses to limited resources and contains the malware attack impact to the restricted domain.

In addition, any runtime software updates or patching will be limited to trusted software from trusted entities, which may be digitally signed for authenticity.

The mitigation against the security threats requires the embedded platform security architecture to use a combination of hardware and software security ingredients such as:

- Measured boot with TPM coupled with appropriate hardware based Root of Trust (RoT); examples: Intel® Trusted Execution Technology (Intel® TXT) or BootROM as Root of Trust
- DRM content protection based on commercial media players executing on Intel architecture

- Application isolation through OS-based mechanisms
- Trusted domains and isolation through OS-based mechanism
- OEM/OSV trusted binaries, which are digitally signed by an authentic source
- Secure storage and key management through TPM assist
- Anti-virus through third party software libraries and application design
- Device management/provisioning through industry standard mechanisms

BootROM RoT: To provide Measured Boot functionality, an embedded platform can support BootROM as hardware RoT and a trusted platform module (TPM) can be used to securely store measurements. Some SPI-Flash controllers support write-protection of the flash device at reset through hardware based auto configuration. Additionally, SPI Flash devices from various vendors allow for boot block write protection through strap pin configuration. Any of these techniques can be used to protect the firmware boot block from being tampered by malware.

In compliance with the TCG specification, the boot firmware is divided into two parts. The first part is the boot block, which is a very small firmware component that includes the minimal platform initialization firmware and TPM driver. The rest of the boot firmware is contained in the subsequent portions of the flash.

The Intel architecture CE device can include other platform-specific firmware that is outside the context of the core BIOS or firmware. An example of this is the p-Unit (microcontroller) that is used for smart power management for the SoC device. This is configured as the first entity where the platform execution begins after reset. Other CE devices may have similar processing elements. Any measured boot mechanism must assure the integrity of such firmware and make it part of the overall trust chain. Figure 16.6 is an example of the trust boundary for a typical Intel architecture CE device.

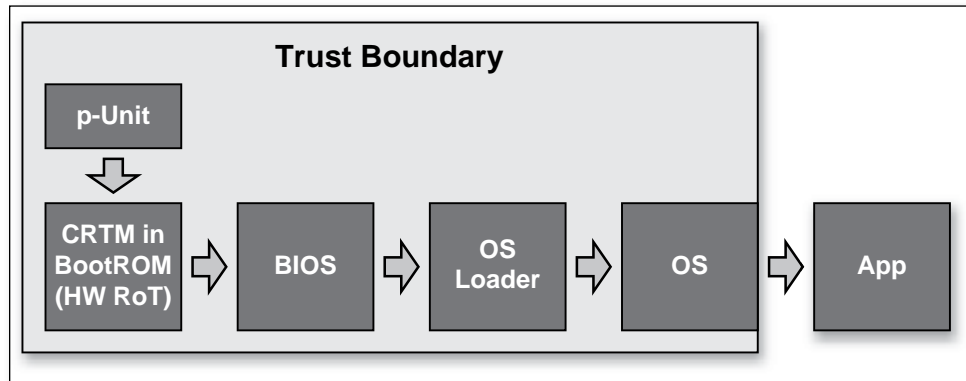

Figure 16.6 Typical Intel® Architecture CE Device Trust Boundary

The BootBlock can be burned into ROM so that it can not be modified and hence can act as a hardware RoT. Core Root of Trust for Measurement (CRTM) is the root of trust from which integrity measurements begin within a trusted CE device platform. The platform manufacturer provides CRTM logic for each trusted platform. The CRTM logic can be changed, but only under controlled conditions by the OEM.

The OS loader, kernel, and drivers will be measured as part of the CE device measured boot flow. The details of a typical chain of trust for measurement with a TPM device and PCR_x are outlined as follows:

- CRTM measures firmware (bootloader or BIOS)
 - Stores the measurement in PCR-0
 - Standard OS handoff tables like ACPI, E820, and EFI measurements are stored in PCR-1
 - Any option ROM measurements are stored in PCR-2
- Bootloader/BIOS measures OS Initial Program Load (IPL)
 - Stores the measurement in PCR-4

- OS loader measures kernel, including kernel command line and drivers
 - Stores the measurement in PCR-8
 - Each OS can use different implementations
 - If the measurements are changed, the OS may fail to boot or alert the user

Measured Boot Latency: Measured boot introduces latencies in the boot path of a CE device due to the following:

- TPM initialization
- Calculation of SHA1 checksum of various binaries
- Appending the checksum in TPM PCR

The measure boot components of the TPM are distributed across the standard firmware boot flow. The CRTM algorithm would play a key role in optimizing for the CE device fast boot. It is beyond the scope of this chapter to describe the various techniques that can be used for this optimization. However, a carefully designed CRTM might use a combination of the following:

- Execute-in-place (out of flash) with processor caches enabled
- Measure only portions of firmware after it is shadowed into memory or before

Manageability

The manageability framework, also known as the Device Management (DM) framework, provides services on the client platform for use by IT personnel remotely. These services facilitate key device management functions such as provisioning, platform configuration changes, system logs, event management, software inventory, and software/firmware updates. The actual services enabled on a particular platform are a CE OEM choice. The following sections describe the two key frameworks in use for a CE device, namely OMA-DM and AMT.

Open Mobile Alliance - Device Management (OMA-DM) is one of the popular protocols that would allow manufacturers to cleanly build

DM applications that fit well into the CE device usage model. Many of the standard operating systems support OMA-DM or a variation of it with enhanced security. The data transport for OMA-DM is typically over a wireless connectivity such as WiMax, 3G/4G, and so on. This protocol can run well on top of the transport layers such as HTTPS, OBEX, and WAP-WSP. The CE device platform would be able to support this, as long as the OEM supports the connectivity and the client services.

The other possible framework for manageability is Intel® Active Management Technology (Intel® AMT). Intel AMT provides a full featured DASH-compliant manageability solution that can discover failures, proactively alert, remotely heal-recover, and protect. Intel AMT Out of Band (OOB) device management allows remote management regardless of device power or OS state. Remote troubleshooting and recovery could significantly reduce OEM service calls. Proactive alerting decreases downtime and minimizes time to repair.

In the manageability space, making DASH-compliant manageability on CE platform is opportunity that allows OEM differentiation and provides a much richer manageability features.

Summary

The need for a boot solution that is low cost, has a small footprint, offers low boot latencies, and is platform-agnostic provides an exciting opportunity to ISVs and OSVs to develop and deliver such tool kits. This also creates opportunities for CE device OEMs to provide creative solutions of their own, making their products more competitive and unique. In addition, device vendors can take advantage of opportunities to provide hardware IP (Intellectual Property) that are self initializing, thereby relieving the boot software from doing the same and giving back some time to improve latencies.

The challenge that remains to be addressed is a single boot firmware solution that can boot both shrinkwrap operating systems that require PC compatibility and embedded operating systems. There are multiple challenges to be addressed with innovative solutions like supporting security features, manageability, and a unified storage device like an eMMC, all with the key low boot latency attribute. Finally, there are opportunities for the OS vendors to come up with innovative optimizations within the OS boot flows to achieve faster boots.

Chapter 17

Manageability

I came, I saw, and I conquered.

—Julius Caesar

RAS is a critical requirement for enterprise class servers, which includes high availability server platforms. System uptime is measured against the goal of “five nines,” which represents 99.999 percent availability. One of the key aims of manageability software is to help achieve this goal, by implementing functions like dynamic error detection, correction, hardware failure prediction, and the taking of corrective actions like replacing or turning off failing components before the failure actually happens. In addition, other noncritical manageability functions enable IT personal to remotely manage a system by performing such operations as remote power up/down, diagnostics, and inventory management. Manageability software can be part of the inline system software (the SMI handler in BIOS and OS) or inline OS user-level application software running on the local processor or on a remote system.

This chapter describes the enhanced Intel® architecture platform dynamic error handling framework, a system level error management infrastructure that is now an integral part of most industry standard server class operating systems. In addition to the above framework, different remote manageability standards are introduced, by comparing and contrasting various aspects and their interoperability at a platform level in achieving the five nines goal.

Overall Management Framework

A robust reporting of platform errors to the OS and a remote management of the platform are considered as fundamental building blocks that enable OS level decision making for various error types and possible actions by remote IT personnel upon notification of the associated events. The framework encompasses a collection of components internal to the OS, platform chipset fabric, and more specifically an enhanced firmware interface for communicating hardware error information between the OS and the platform.

By standardizing the interfaces and error reporting through which hardware errors are presented to, configured for, signaled to, and reported through the framework, the management software would be presented with a myriad of opportunities. The two categories of error/event types that need active management in a platform are illustrated in Figure 17.1 and can be enumerated as *in-band* and *out-of-band mechanisms*.

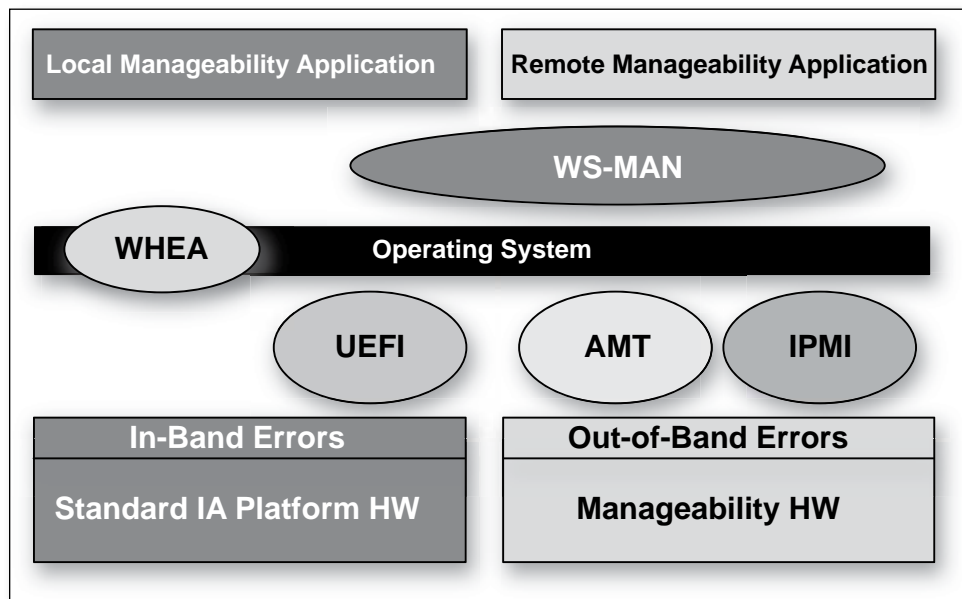

Figure 17.1 Manageability Domains

The various classes of manageability implementations handling these two classes of errors/events are as follows:

- Traditional UEFI/BIOS power-on self tests/diagnostics (POST)
- UEFI/BIOS based dynamic error functions coupled with SMI/PMI¹ for dynamic error management
- Server baseboard management controllers (BMC) Out-Of-Band (OOB) Intelligent Platform Management Interface (IPMI) implementations
- Client/Mobile Intel® Active Management Technology (Intel AMT) OOB implementations
- OS based dynamic error management

Dynamic in-band errors like 1xECC, 2xECC on memory or PCIe[†] corrected/uncorrected impact the running system and its uptime attribute in the near to immediate future depending on the severity, while out-of-band errors due to peripheral system components like fan failure, thermal trips, intrusion detection, and so on are not fatal. While in-band errors need immediate system attention and error handling to maintain the uptime, most out-of-band errors would need the attention of manageability software for deferred handling. However, over a period time both categories of errors/events if not handled properly will impact the system uptime.

Dynamic In-Band

In-Band error management is typically handled by software that is part of the standard system software stack consisting of system BIOS (SMI/PMI), operating system, device drivers/ACPI control methods, and user mode manageability applications running on the target system. The key technologies that are covered in this context are as follows:

- Standardized UEFI error format

¹ SMI: System Management Interrupt of x86 processor; PMI: Platform Management Interrupt of Itanium® processor

- Various platform error detection, reporting, and handling mechanisms
- Windows Hardware Error Architecture (WHEA) as an example that leverages UEFI standards

Out-of-Band

Out-of-band error management is handled by out-of-band firmware such as, for example, firmware running on BMCs conforming to IPMI standards. The key technologies that are covered in this space are:

- IPMI
- Intel AMT
- DMTF and DASH as they relate to IPMI and Intel AMT

IPMI is prevalent on server class platforms through the use of an industry standard management framework or protocol like WS-MAN. The following section focuses more on the in-band error domain and the most recent advancements, followed by out-of-band error management technology domain(s) and a way to bridge the two in a seamless way at the target platform level: servers, desktop client, mobile, and so on.

The other domain of management for client and mobile systems is through the Intel AMT feature, which allows IT to better discover, heal, and protect their networked client and desktop computing assets using built-in platform capabilities and popular third-party management and security applications. Intel AMT today is primarily based on the out-of-band implementations as explained above and allows access to information on a central repository stored in the platform nonvolatile memory (NVM).

Distributed Management Task Force (DMTF)

The DMTF is an industry organization that is leading the development, adoption, and promotion of interoperable management initiatives and standards. Further details on this will be covered later in this chapter.

UEFI Error Format Standardization

In this section, we delve into the first level details of the in-band errors and their handling based on the UEFI standard.

On most platforms, standard higher level system software like shrink-wrap operating systems directly log available in-band system dynamic error information from the processor and chipset architectural error registers to a nonvolatile storage. These errors are signaled at system runtime through various event notification mechanisms like machine check exception on Intel® architecture processors (example: int-18) or NMI, system management interrupt (SMI) or standard interrupts like ACPI defined SCI. The challenge is and always has been to get non-architectural information from the platform, which is typically not visible to a standard OS, but to the system specific firmware only. Partial platform error information from the architectural sources (such as Machine Check Bank machine specific registers (MSR) as in x86 processor or as returned by the processor firmware PAL on Itanium®) alone is not sufficient for detailed and meaningful error analysis or corrective action. Moreover, neither the OS nor other third party manageability software has knowledge about how to deal with raw information from the platform, or how to parse and interpret it for meaningful error recovery or manageability healing actions.

The Figure 17.2 illustrates a typical dynamic error handling on most platforms with shrink-wrap OS implementations, for two different error handling components of notification/signaling and logging. In this model, a component of the OS kernel directly logged the error information from the processor architectural registers, while platform firmware logged non-architectural error information to a nonvolatile storage for its private usage, with no way to communicate this back to the OS and vice versa. Both the platform events (SMI) and processor events (MCE) are decoupled from each other.

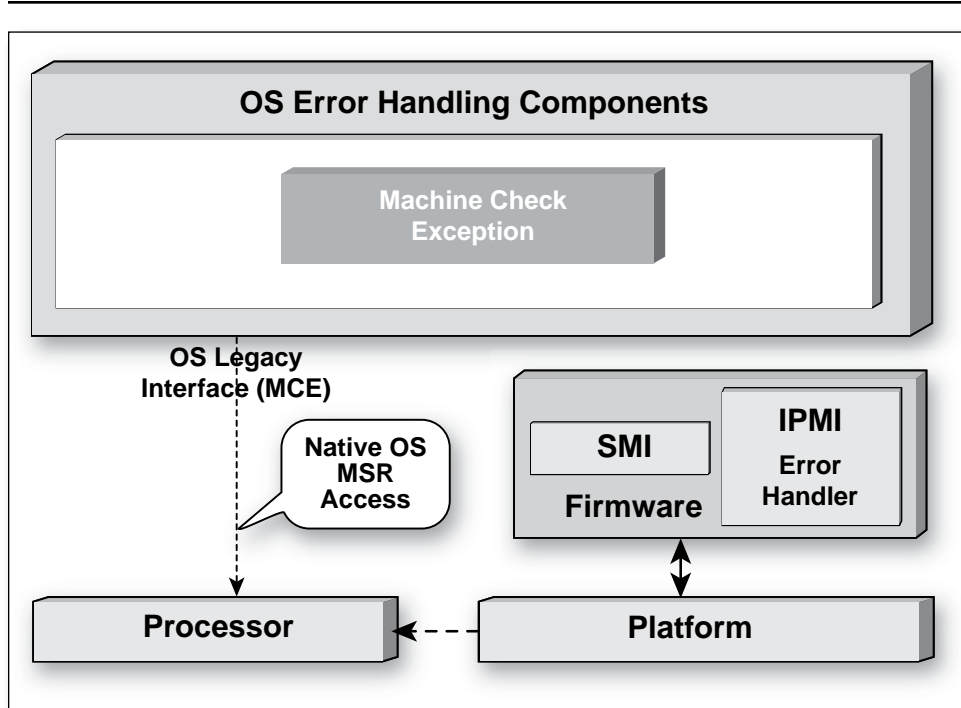

Figure 17.2 Traditional OS Error Reporting Stack

To make the system error reporting solution complete, the manageability software will have to be provided with the following:

- Processor error logs
- Implementation-specific hardware error logs, such as from platform chipset
- Industry Standard Architecture hardware error logs, such as PCIe Advance Error Reporting registers (AER)
- System event logs (SELs) as logged by BMC-IPMI implementations

As can be seen in Figure 17.3, there is a coordination challenge between different system software components managing errors for different platform hardware functions. Some of the error events (such as interrupts, for example) managed by platform entities not visible to the OS may eventually get

propagated to the OS level, but with no associated information. Therefore, an OS is also expected to handle an assortment of hardware error events from several different sources, with limited information and knowledge of their control path, configuration, signaling, error log information, and so on. This created synchronization challenges across the platform software components when accessing the error resources, especially when they are shared between firmware and OS, such as in the case of I/O devices like PCI or PCIe. For example when the OS does receive a platform-specific error event/interrupt like NMI, it would have no clue about what caused it and how to deal with it.

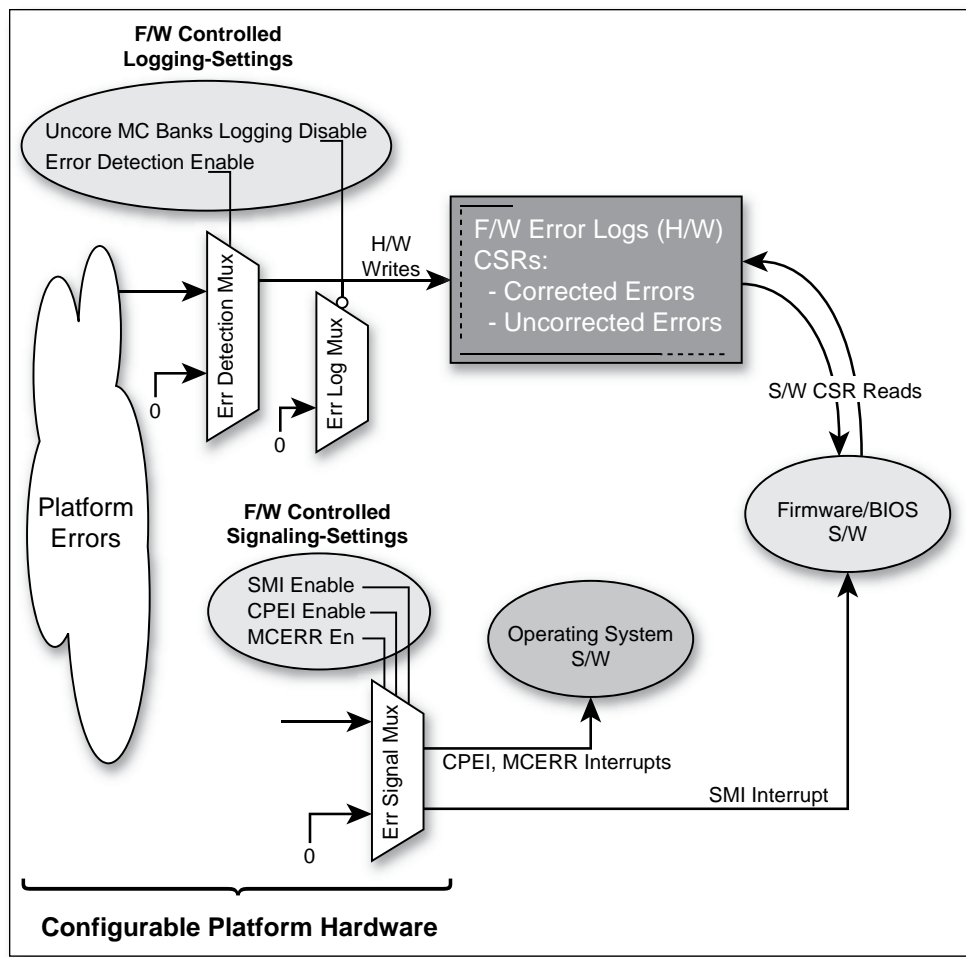

Figure 17.3 Traditional OS Error Reporting Stack

Based on this state of OS error handling and the identified needs for future enhancements, a new architecture framework has been defined. This framework is based on the top-down approach, with the OS usage model driving various lower level system component behaviors and interfaces.

Error management includes two different components, namely error notification/signaling and error logging/reporting, for all system errors. The fundamental component of this architecture is a model for error management, which includes an architected platform firmware interface to the OS. This interface was defined to facilitate the platform to provide error information to the OS in a standardized format. This firmware-based enhanced error reporting will coexist with legacy OS implementations, which are based on direct OS access to the architected processor hardware error control and status registers, such as the processor machine check (MC) Banks.

The architected interface also gives the OS an ability to discover the platform's error management capabilities and a way to configure it for the chosen usage model with the help of standardized error objects. This enables the OS to make the overall system error handling policy management decisions through appropriate system configuration and settings.

To facilitate abstracted error signaling and reporting for most common platform in-band errors, namely those emanating from the processor and chipset, a new UEFI/ACPI Error Interface extension was defined with the following goals:

- Achieve error reporting abstraction for architectural and non-architectural platform functional hardware
- An access mechanism for storage/retrieval of error records to the platform NVM, for manageability software use
- Allowing freedom of platform implementation, including firmware based preprocessing of errors
- Allow discovery of platform error sources, its capabilities and configurability through firmware assist
- Standardized error log formats for key hardware

Figure 17.4 illustrates various components with UEFI extensions to satisfy the above goals.

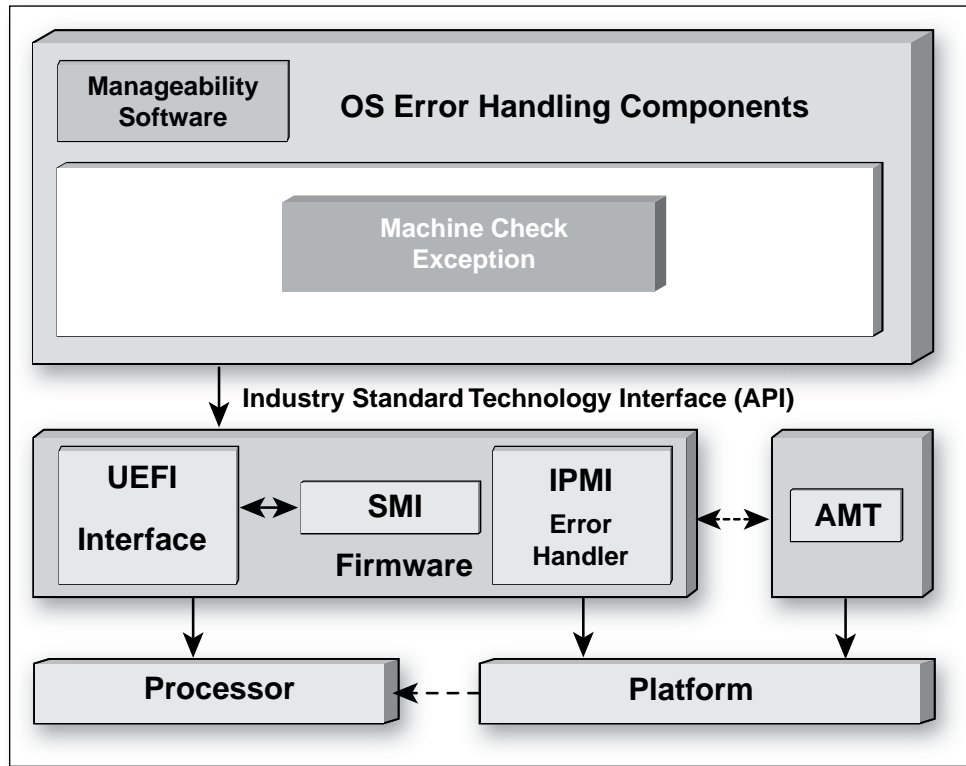

Figure 17.4 OS Error Reporting Stack with UEFI Standardization

Non-Goals: The UEFI specification did not cover the following:

- Details of the platform hardware design or signal routing
- OS or other system software error handling implementations or error handling policies
- Usage model of this interface
- Standardized error log formats for all hardware

UEFI Error Format Overview

The error interface consists of a set of OS runtime APIs implemented by system firmware accessed through UEFI or SMI runtime interface mechanisms. These standardized APIs will provide the following capabilities:

- Error reporting to OS through *standardized* error log formats as defined by other specifications
- The ability to store OS and OEM specific records to the platform nonvolatile storage in a *standardized* way and manage these records based on an implementation-specific usage model
- Ability to discover platform implementation capabilities and their configuration through *standardized* platform specific capability record representation

This specification only covers the runtime API details. It is based on coordination between different system stack components through architected interfaces and flows. It requires cooperation between system hardware, firmware, and software components. The platform nonvolatile storage services are the minimum required features for this error model.

Error Record Types

The API provides services to support different predefined record types. Each record type being accessed is identified by an architected unique Record ID, which is managed by the interface. The Record format will remain constant across all implementations, allowing different software implementations to interoperate in a seamless way. Record types can include GUIDs representing records belonging to different categories as follows:

1. *Notification Types*. Standard GUIDs as defined in the common error record format for each of the error record types, which are associated with information returned for different event notification types (examples: NMI, MCE, and so on).
2. *Creator Identifier*. This can correspond to the CreatorID GUID as specified in the common error record format or other additional vendor defined GUID.

3. *Error Capability.* This is a GUID as defined by the platform vendor for platform implemented error feature capability discovery and configuration record types.

Error Notification Type

Error notification type records are based on notification types that are associated with standard event signaling/interrupts, each of which is identified by an architecturally assigned GUID and are as defined below:

- Corrected Machine Check (CMC)
- Corrected Platform Error (CPE)
- Machine Check Exception (MCE)
- PCI Express error notification (PCIe)
- Initialization (INIT)
- Non-Maskable Interrupt (NMI)
- Boot
- DMAR

Creator Identifier

Creator ID record types are associated with event notification types, but the actual creator of the error record can be one of the system software entities. This creator ID is a GUID value pre-assigned by the system software vendor. This value may be overwritten in the error record by subsequent owners of the record than the actual creators, if it is manipulated. The standard creator IDs defined are as follows:

- Platform Firmware as defined by the firmware vendor
- OS vendor

■ OEM

An OS saved record to the platform nonvolatile storage will have an ID created by the OS, while platform-generated records will have a firmware creator ID. The creator ID has to be specified during retrieval of the error record from platform storage. Other system software vendors (OS or OEM) must define a valid GUID.

Error Capability

The error capability record type is associated with platform error capability reporting and configuration. Error capability is reserved for discovering platform capabilities and its configuration.

For further details on the APIs to get/set/clear error records from the non-volatile storage on the platform through UEFI, refer to the UEFI 2.3 or above specification.

Windows Hardware Error Architecture and the Role of UEFI

Prior to the UEFI common error format standardization, most of the operating systems supported several unrelated mechanisms for reporting hardware errors. The ability to determine the root cause of hardware errors was hindered by the limited amount of error information logged in the OS system event log. These mechanisms provided little support for error recovery and graceful handling of uncorrected errors.

The fundamental basis for this architecture is the reporting of platform error log information to the OS in a standardized format, so that it is made available to manageability software. In addition, a standard access mechanism to this error information through UEFI and ACPI has also been defined, both for Itanium and x86 platforms as a runtime UEFI API Get/Set Variable. This enabled all OS implementations such as Windows, Linux, HP-UX and platform BIOS implementations to conform to one standard for easier coordination and synchronization during an error condition. This is the fundamental building block that has enabled interoperability across different manageability software, written either by the OS vendors, BIOS vendors, or third party application vendors by allowing them to understand and speak the same language to communicate error source discovery, configuration, and data format representation.

The Windows Hardware Error Architecture (WHEA), introduced with Windows Vista, extends the previous hardware error reporting mechanisms and brings them together as components of a coherent hardware error infrastructure. WHEA takes advantage of the additional hardware error information available in today's hardware devices and integrates much more closely with the system firmware, namely the UEFI standardized error formats.

WHEA can be summarized in a nutshell as:

- UEFI Standardized Common error record format
 - Management applications benefit
 - Pre-boot and out-of-band applications
 - Architecturally defined for processor, memory, PCIe, and so on
- Error source discovery
 - Fine-grained control of error sources
- Common error handling flow
 - All hardware errors processed by same code path
- Hardware error abstractions became operating system first-class citizens
 - Enables error source management
- Firmware first error model
 - Some errors may be handled in firmware before the OS is given control, like errata management and error containment

As a result, WHEA provides the following benefits:

- Allows for more extensive error data to be made available in a standard error record format for determining the root cause of hardware errors.
- Provides mechanisms for recovering from hardware errors to avoid bugchecking the system when a hardware error is nonfatal.

- Supports user-mode error management applications and enables advanced computer health monitoring by reporting hardware errors via Event Tracing for Windows (ETW) and by providing an API for error management and control.
- Is extensible, so that as hardware vendors add new and better hardware error reporting mechanisms to their devices, WHEA allows the operating system to gracefully accommodate the new mechanisms.

The UEFI standard has now defined error log formats for the most common platform components like processor, memory, PCIe, and so on, in addition to error source based discovery and configuration through ACPI tables. These error formats provide a higher level of abstraction. It is beyond the scope of this book to get into the details, but an overview of error log format is illustrated in Figure 17.6. Each of the error events is associated with a record, consisting of multiple error sections, where the sections conforms to standard platform error types like processor, memory, PCIe, and so on, identified by a pre-assigned GUID. The definition of the format is scalable and allows for the support of other nonstandard OEM-specific formats, including the IPMI SEL event section.

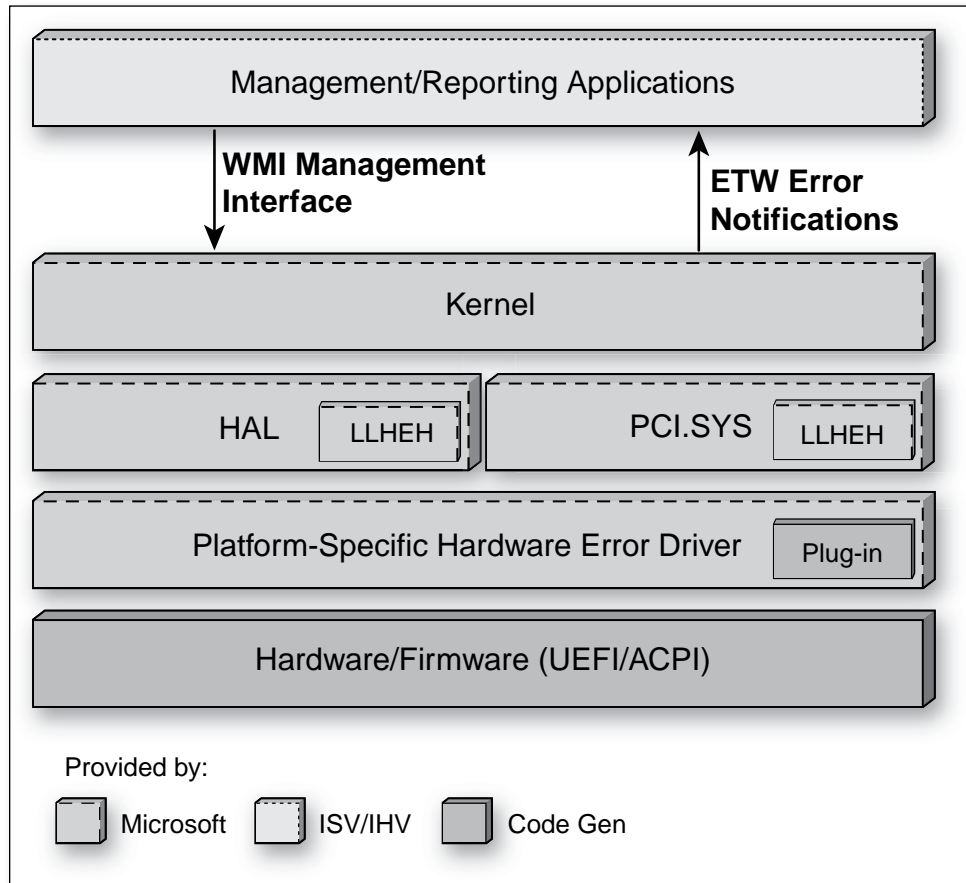

Figure 17.5 WHEA Overview

The layout of the UEFI standardized error record format used by WHEA is illustrated in Figure 17.6.

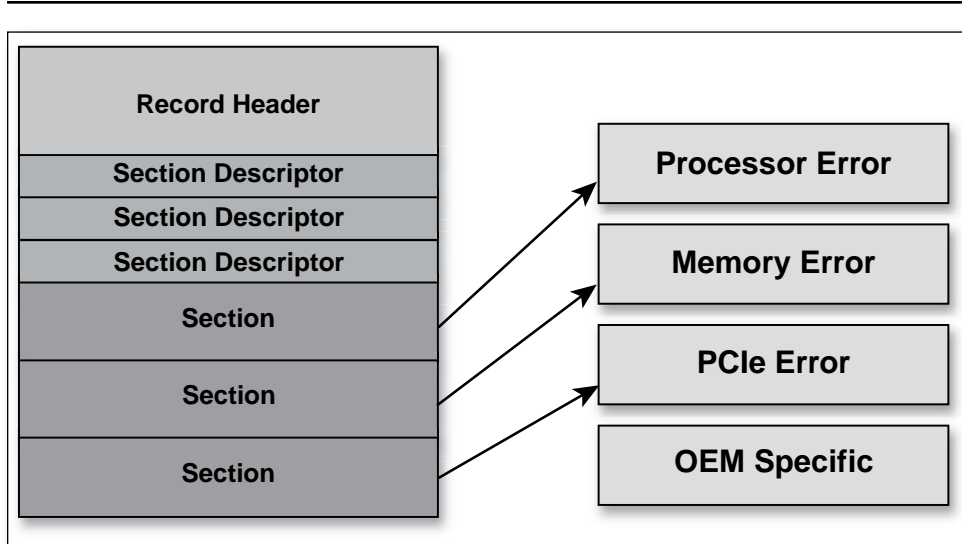

Figure 17.6 UEFI Standard Error Record Format

Some of the standard error sources and global controls covered by WHEA/UEFI are as described in Table 17.1.

Table 17.1 Standard Error Sources and Global Controls Covered by WHEA/UEFI

Error Sources	System Interrupts and Exceptions: NMI, MCE, MCA, CMCI, PCIe, CPEI, SCI, INTx, BOOT
Standard Error Formats	Processor, Platform Memory, PCIe, PCI/PCI-X Bus, PCI Component

It is beyond the scope of this chapter to go into the details of the dynamic error handling flow. However, Figure 17.7 provides an overview of the error handling involving the firmware and OS components.

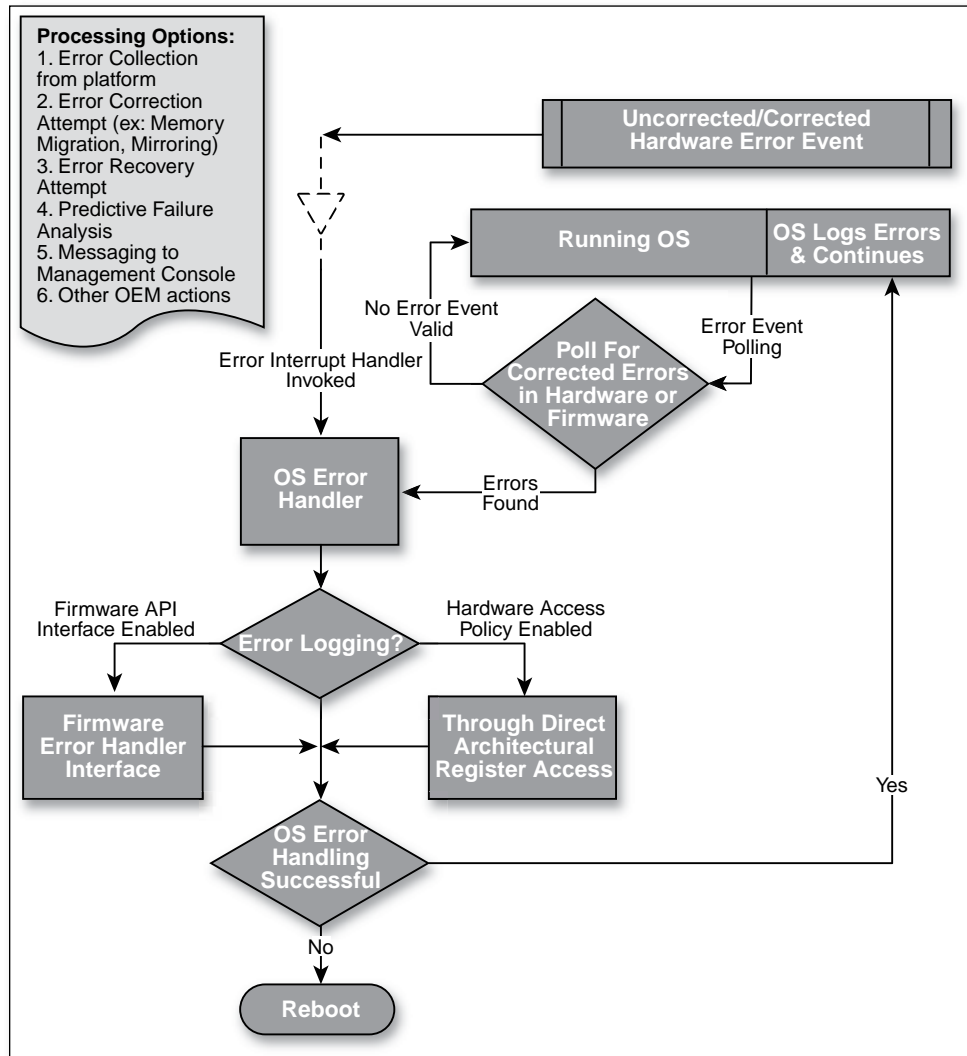

Figure 17.7 Generic Error Handling Flow

Technology Intercepts: UEFI, IPMI, Intel® AMT, WS-MAN

The following sections delve into various other management technologies that relate to UEFI and how these all can interoperate.

Intelligent Platform Management Interface (IPMI)

IPMI is a hardware level interface specification that is “management software neutral” providing monitoring and control functions for Server platforms, that can be exposed through standard management software interfaces such as DMI, WMI, CIM, SNMP, and HPI. IPMI defines common, abstracted, message-based interfaces between diverse hardware devices and the CPU. IPMI also defines common sensors for describing the characteristics of such devices, which are used to monitor out-of-band functions like fan/heat sink failures, and intrusion detection. Each platform vendor offers differentiation through their own platform hardware implementation to support IPMI, typically implemented with an embedded baseboard microcontroller (BMC) and the associated firmware with a set of event sensors, as shown in Figure 17.8.

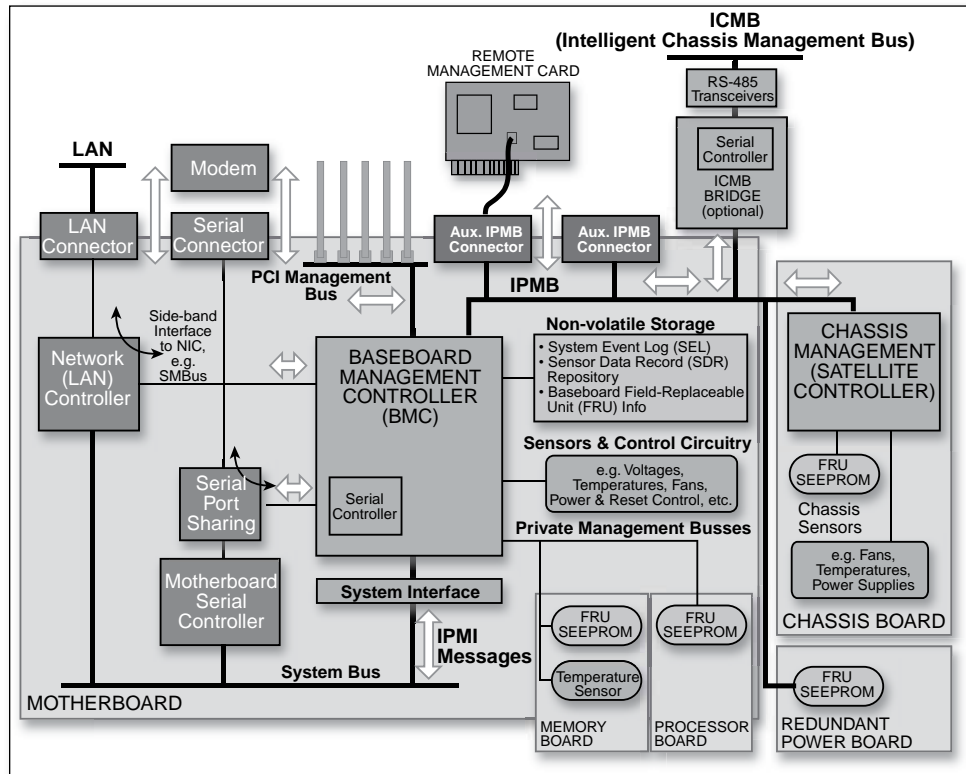

Figure 17.8 Typical IPMI Platform Implementation

IPMI has defined a set of standard sensors, which would monitor different platform functions and generate events and report them through the system event log interface (SEL) as 16-byte error log entries. Each of the sensors in turn is associated with Sensor Data Record (SDR), which describes the properties of the sensor, to let the manageability software discover its capability, configurability and controllability and the error record associated with it. A set of predefined controls for use by manageability software is also defined by the IPMI specification, in addition to other OEM-defined controls through SDR. The standard sensors along with the standard controls do allow a level of standardization for managing these out-of-band errors. Some of the standard sensor and global controls are as described captured below in Table 17.2.

Table 17.2 IPMI Standard Sensor and Global Controls

Sensors	Temp, Voltage, Current, Processor, Physical Security, Platform Security, Processor, Power Supply, Power Unit, Cooling, Memory, Drive Slot, BIOS POST, Watch Dog, System Event, Critical Interrupt, Button/Switch, Add in Card, Chassis, Chipset, FRU, Cable, System Reboot, Boot Error, OS Boot, OS Crash, ACPI Power State, LAN, Platform Alert, Battery, Session Audit
Global Control	Cold Reset, Warm Reset, Set ACPI State

Intel® Active Management Technology (Intel AMT)

Intel AMT can be viewed as an orthogonal solution to IPMI and was originally developed with capabilities for client system manageability by IT personnel in mind, as opposed to server manageability. However, Intel AMT is making its way into the embedded and network appliance market segments like point of sale terminals, print imaging, and digital signage. Intel AMT is a hardware- and firmware-based solution connected to the system's auxiliary power plane, providing IT administrators with “any platform state” access. Figure 17.9 provides an illustration of Intel AMT's architecture. Intel AMT enables secure, remote management of systems through unique built-in capabilities, including:

- OOB management that provides a direct connection to the Intel AMT subsystem, either through the operating system's network connection or via its TCP/IP firmware stack.
- Nonvolatile memory that stores hardware and software information, so IT staff can discover assets even when end-user systems are powered off, using the OOB channel.
- System defense featuring inbound and outbound filters, combined with presence detection of critical software agents, protects against malware attacks, and so on.

The most recent versions of the Intel AMT are DASH-compliant and facilitate interoperability with remote management consoles that are DASH-compliant.

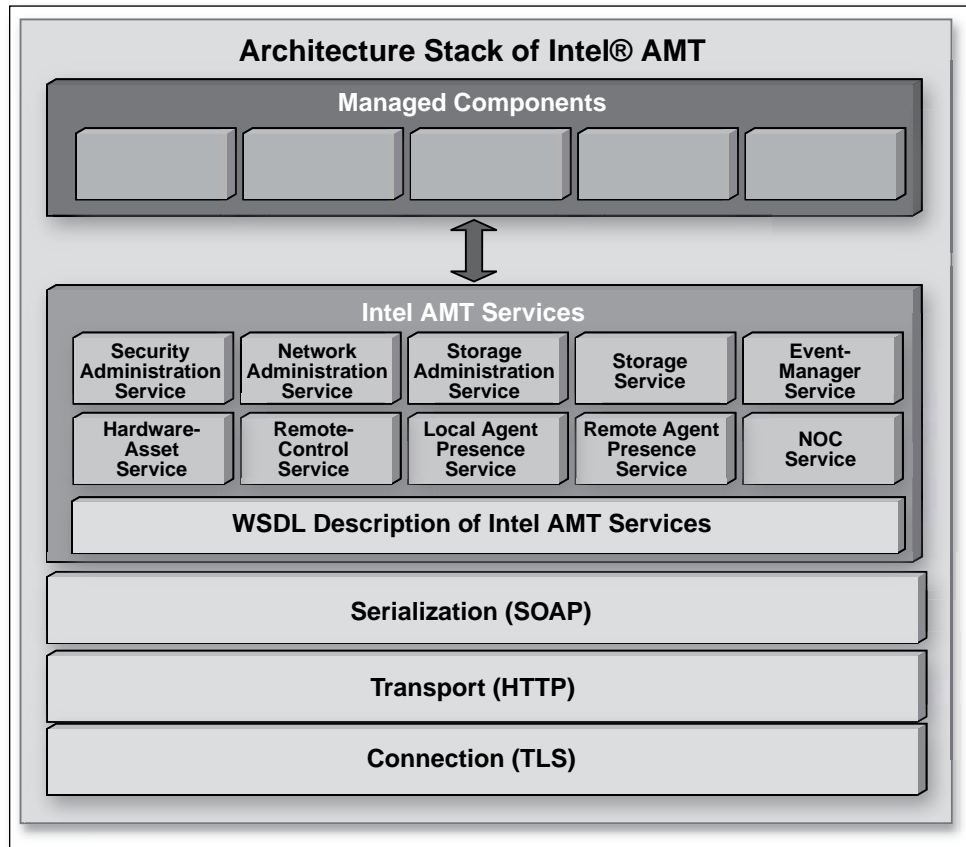

Figure 17.9 Intel® AMT Architecture Stack

Intel AMT offering includes Manageability Engine hardware with the associated firmware, which is integrated onto silicon as building blocks such as IOH or PCH. Intel AMT allows users to remotely perform power functions, launch a serial over LAN session to access a system's BIOS and enable IDE-Redirect to boot a system from a floppy, image, or CD/DVD device installed within the central monitor. Some of the key services provided through Intel AMT are as shown in Table 17.3.

Table 17.3 Key Services Provided through Intel® AMT

Services	Security Administration Interface, Network Administration Interface, Hardware Asset Interface, Remote Control Interface, Storage Interface, Event Management Interface, Storage Administration Interface, Redirection Interface, Local Agent Presence Interface, Circuit Breaker Interface, Network Time Interface, General Info. Interface, Firmware Update Interface
Global Control	Cold Reset, Warm Reset, Power Up and Down, Set Power/ACPI State, Change ACL, Retrieve Hardware/Software Inventory, Firmware Update, Set Clock, Set Firewall Configuration, Configure Platform Events for Alert and Logging

Like IPMI, one of the key interfaces of Intel AMT is event management, which allows configuring hardware and software events to generate alerts and to send them to a remote console and/or log them locally.

Web Services Management Protocol (WS-MAN)

The growth and success of enterprise businesses hinges heavily on the ability to control costs while expanding IT resources. WS-Management addresses the cost and complexity of IT management by providing a common way for systems to access and exchange management information across the entire IT infrastructure. By using Web services to manage IT systems, deployments that support WS-Management will enable IT managers to remotely access devices on their networks—everything from silicon components and handheld devices to PCs, servers, and large-scale data centers. WS-Management is an open standard defining a SOAP-based protocol for the management of remote systems, as illustrated in Figure 17.10.

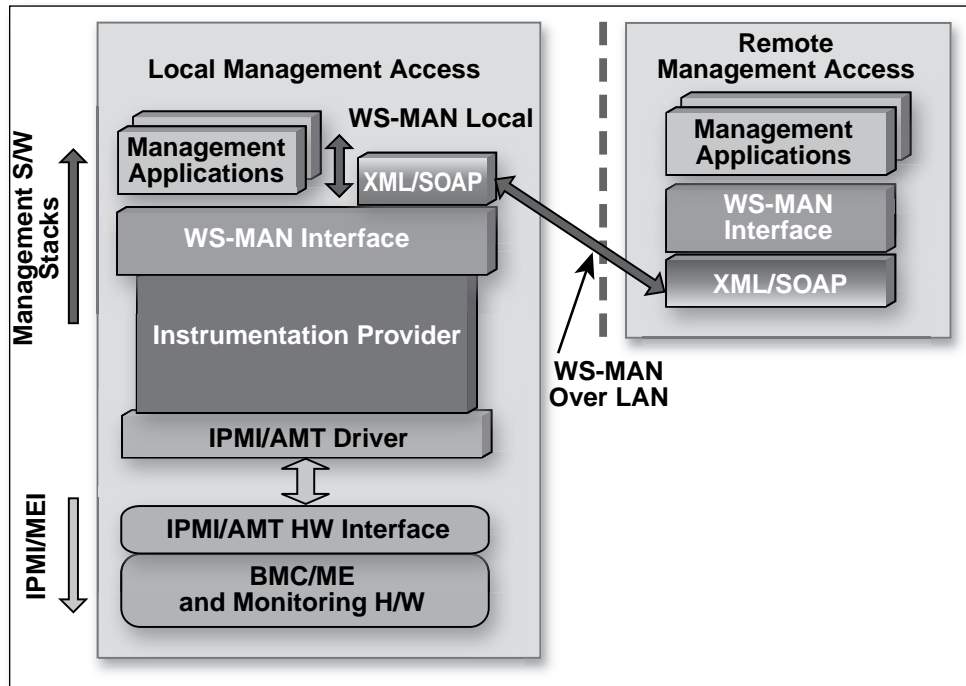

Figure 17.10 WS-MAN Management Build Blocks Overview

All desktop, mobile, and server implementations that are compliant with DASH and support WS-MAN can be remotely managed over the same infrastructure like the management console applications.

Other Industry Initiatives

The Distributed Management Task Force, Inc. (DMTF) is the industry organization leading the development, adoption, and promotion of interoperable management initiatives and standards. DMTF management technologies include the Common Diagnostic Model (CDM) initiative, the Desktop Management Interface (DMI), the System Management BIOS (SMBIOS), the Systems Management Architecture for Server Hardware (SMASH) initiative, Web-Based Enterprise Management (WBEM)—including protocols such as CIM-XML and Web Services for Management (WS-Management)—which are all based on the Common Information Model (CIM). Information about the DMTF technologies and activities can be found at www.dmtf.org.

The UEFI/IPMI/Intel® AMT/WS-MAN Bridge

This part of the analysis brings out the way these different management technologies and interfaces can be bridged together, either with the already available hooks in them or with some yet-to-be-defined extensions, as illustrated in Figure 17.11.

The previous section discussed the UEFI industry standard specification covering the common error formats for in-band errors and how manageability software running on top of the OS can take immediate corrective action through the abstracted interface. However, the common event log format for out-of-band errors is not covered by UEFI, but is left to the individual platform vendors to implement through either IPMI or Intel AMT interfaces.

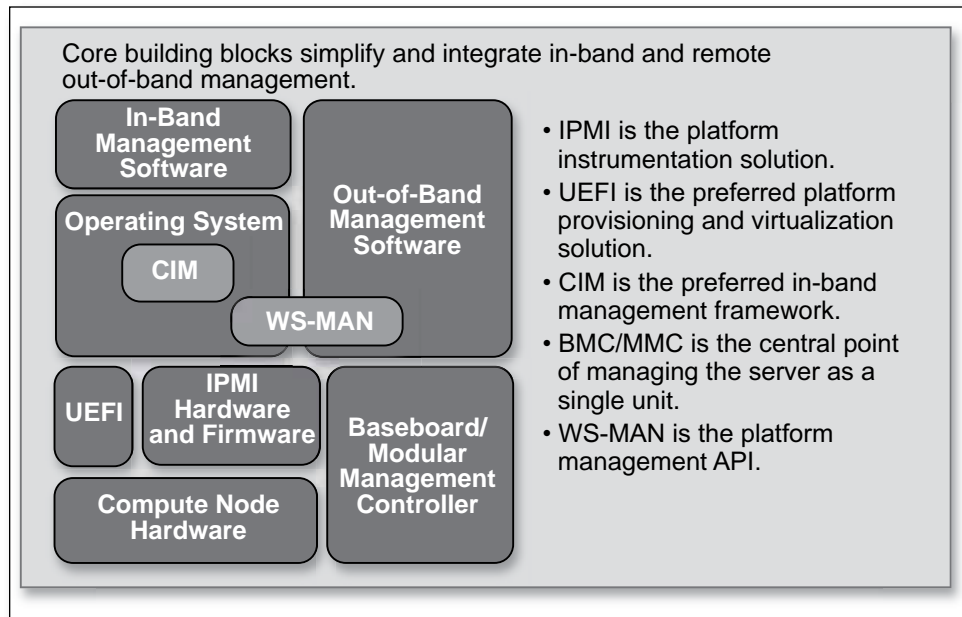

Figure 17.11 Management Build Blocks Linking IPMI, HPI, UEFI, and WHEA

IPMI Error Records to UEFI

UEFI can act as a conduit for all the SEL event log information for out-of-band errors logged by IPMI and provide it to UEFI, encapsulated as a UEFI standardized OEM-specific error format to the OS. This requires a private

platform-specific interface between UEFI and the IPMI firmware layers for exchange of this information. It is also possible for the UEFI to extend and define yet another error format for IPMI SEL logs identified with a new GUID. This way, an OS or manageability application would be able to get complete platform errors for in-band and out-of-band errors in a standardized format through one single UEFI-based interface. UEFI can intercept the IPMI sensor events through the firmware first model as defined by Microsoft WHEA and provide the SEL logs to the OS. This type of extension can be modeled along the Itanium Processor Machine Check Architecture specification for IPMI error logging and is an area of opportunity of future standardization effort.

UEFI Error Records to IPMI

The IPMI has already defined standard event sensors like Processor, Memory, System Event, Chipset and Platform Alert. It is also possible to define a new UEFI or WHEA sensor type for IPMI and channel the UEFI defined standard error formatted information over to IPMI, encapsulated as OEM-specific data of a variable size. IPMI SEL log size is currently defined to be 16-bytes and hence would require a change in IPMI specification to support variable size SEL log size. This way, a remote or local manageability application would be able to get complete in-band and out-of-band error information through one single IPMI.

Intel® AMT and IPMI

These two interfaces, which were defined with different usage models in mind, do have an overlap in functionality. Intel AMT defines an entire hardware and firmware framework for client system management, while IPMI only defined the firmware interface without any hardware support for server system manageability.

Future Work

Table 17.4 shows the four areas of potential work for standardization that offers interesting possibilities:

- Bridge over the Intel AMT/IPMI functionality over to the UEFI-OS error reporting

- Bridge over of the OS-UEFI error management over to the Intel AMT/IPMI functionality
- Manageability application leveraging from WS-MAN or other similar abstracted interfaces with a unified error reporting and management for the entire platform, either obtained through the OS or Intel AMT/IPMI.

Table 17.4 Manageability and error management standards and possible future work.

Error Management Feature	UEFI/WHEA	IPMI	AMT	WS-MAN
Bridging Over Possibilities	IPMI/AMT	AMT	IPMI	UEFI/WHEA

Summary

In the case of manageability, the UEFI framework will help make platforms more robust and reliable through remote management interfaces like Intel AMT, and WS-MAN, to meet the RAS goal of five nines. This unified approach would be a win-win to all (OEM, IBV, OSV), to deliver a great end user value and experience with a complete solution for in-band and out-of-band error and event management.

The net result of the level of abstraction provided by UEFI/WHEA and Intel AMT/IPMI technologies in security and manageability space will now enable many vendors to develop OS-agnostic unified tools and application software for all embedded/client/server platforms. This would allow them to spend their efforts on innovation with a rich set of features at the platform level rather than on developing multiple platform-specific implementations for the same manageability functionality.

Appendix **A**

Data Types

Table A.1 contains the set of base types that are used in all UEFI applications and EFI drivers. Use these base types to build more complex unions and structures. The file `EFIBIND.H` in the UDK 2010 located on www.tianocore.org contains the code required to map compiler-specific data types to the UEFI data types. If you are using a new compiler, update only this one file; all other EFI related sources should compile unmodified. Table A.2 contains the modifiers you can use in conjunction with the UEFI data types.

Table A.1 Common EFI Data Types

Mnemonic	Description
BOOLEAN	Logical Boolean. 1-byte value containing a 0 for FALSE or a 1 for TRUE. Other values are undefined.
INTN	Signed value of native width. (4 bytes on IA-32, 8 bytes on Itanium®-based operations)
UINTN	Unsigned value of native width. (4 bytes on IA-32, 8 bytes on Itanium®-based operations)
INT8	1-byte signed value.
UINT8	1-byte unsigned value.
INT16	2-byte signed value.
UINT16	2-byte unsigned value.
INT32	4-byte signed value.
UINT32	4-byte unsigned value.
INT64	8-byte signed value.

UINT64	8-byte unsigned value.
CHAR8	1-byte Character.
CHAR16	2-byte Character. Unless otherwise specified all strings are stored in the UTF-16 encoding format as defined by Unicode 2.1 and ISO/IEC 10646 standards.
VOID	Undeclared type.
EFI_GUID	128-bit buffer containing a unique identifier value. Unless otherwise specified, aligned on a 64-bit boundary.
EFI_STATUS	Status code. Type INTN.
EFI_HANDLE	A collection of related interfaces. Type VOID *.
EFI_EVENT	Handle to an event structure. Type VOID *.
EFI_LBA	Logical block address. Type UINT64.
EFI_TPL	Task priority level. Type UINTN.
EFI_MAC_ADDRESS	32-byte buffer containing a network Media Access Control address.
EFI_IPv4_ADDRESS	4-byte buffer. An IPv4 Internet protocol address.
EFI_IPv6_ADDRESS	16-byte buffer. An IPv6 Internet protocol address.
EFI_IP_ADDRESS	16-byte buffer aligned on a 4-byte boundary. An IPv4 or IPv6 Internet protocol address.
<Enumerated Type>	Element of an enumeration. Type INTN.
sizeof (VOID *)	4 bytes on supported 32-bit processor instructions. 8 bytes on supported 64-bit processor instructions.

Table A.2 Modifiers for Common EFI Data Types

Mnemonic	Description
IN	Datum is passed to the function.
OUT	Datum is returned from the function.
OPTIONAL	Datum is passed to the function is optional, and a NULL may be passed if the value is not supplied.
STATIC	The function has local scope. This replaces the standard C static key word, so it can be overloaded for debugging.
VOLATILE	Declare a variable to be volatile and thus exempt from optimization to remove redundant or unneeded accesses. Any variable that represents a hardware device should be declared as VOLATILE.
CONST	Declare a variable to be of type const. This is a hint to the compiler to enable optimization and stronger type checking at compile time.
EFIAPI	Defines the calling convention for EFI interfaces. All EFI intrinsic services and any member function of a protocol must use this modifier in the function definition.

Appendix **B**

Status Codes

Most UEFI interfaces return an EFI_STATUS code. Table B.1 lists the status code ranges. Tables B.2, B.3, and B.4 list these codes for success, errors, and warnings, respectively. Error codes also have their highest bit set, so all error codes have negative values. The range of status codes that have the highest bit set and the next to highest bit clear are reserved for use by UEFI. The range of status codes that have both the highest bit set and the next to highest bit set are reserved for use by OEMs. Success and warning codes have their highest bit clear, so all success and warning codes have positive values. The range of status codes that have both the highest bit clear and the next to highest bit clear are reserved for use by UEFI. The range of status code that have the highest bit clear and the next to highest bit set are reserved for use by OEMs.

Table B.1 EFI_STATUS Code Ranges

IA-32 Range	Intel® Itanium® Architecture Range	Description
0x00000000– 0x1fffffff	0x0000000000000000– 0x1fffffffffffffffff	Success and warning codes reserved for use by UEFI main specification. See Tables B.2 and B.4 for valid values in this range.
0x20000000– 0x3fffffff	0x2000000000000000– 0x3fffffffffffffffff	Success and warning codes reserved for use by the Platform Initialization Architecture Specification.
0x40000000– 0x7fffffff	0x4000000000000000– 0x7fffffffffffffffff	Success and warning codes reserved for use by OEMs.

0x80000000– 0x9fffffff	0x8000000000000000– 0x9fffffffffffffffff	Error codes reserved for use by the UEFI main specification. See Table B.3 for valid values for this range.
0xa0000000– 0xbfffffff	0xa000000000000000– 0xb000000000000000	Error codes reserved for use by the Platform Initialization Architecture Specification.
0xc0000000– 0xffffffff	0xc000000000000000– 0xffffffffffffffff	Error codes reserved for use by OEMs.

Table B.2 EFI_STATUS Success Codes (High Bit Clear)

Mnemonic	Value	Description
EFI_SUCCESS	0	The operation completed successfully.

Table B.3 EFI_STATUS Error Codes (High Bit Set)

Mnemonic	Value	Description
EFI_LOAD_ERROR	1	The image failed to load.
EFI_INVALID_PARAMETER	2	A parameter was incorrect.
EFI_UNSUPPORTED	3	The operation is not supported.
EFI_BAD_BUFFER_SIZE	4	The buffer was not the proper size for the request
EFI_BUFFER_TOO_SMALL	5	The buffer is not large enough to hold the requested data. The required buffer size is returned in the appropriate parameter when this error occurs.
EFI_NOT_READY	6	There is no data pending upon return.
EFI_DEVICE_ERROR	7	The physical device reported an error while attempting the operation.
EFI_WRITE_PROTECTED	8	The device cannot be written to.
EFI_OUT_OF_RESOURCES	9	A resource has run out.
EFI_VOLUME_CORRUPTED	10	An inconsistency was detected on the file system causing the operation to fail.
EFI_VOLUME_FULL	11	The file system has no more space.
EFI_NO_MEDIA	12	The device does not contain any medium to perform the operation.
EFI_MEDIA_CHANGED	13	The medium in the device has changed since the last access.
EFI_NOT_FOUND	14	The item was not found.

EFI_ACCESS_DENIED	15	Access was denied.
EFI_NO_RESPONSE	16	The server was not found or did not respond to the request.
EFI_NO_MAPPING	17	A mapping to a device does not exist.
EFI_TIMEOUT	18	The timeout time expired.
EFI_NOT_STARTED	19	The protocol has not been started.
EFI_ALREADY_STARTED	20	The protocol has already been started.
EFI_ABORTED	21	The operation was aborted.
EFI_ICMP_ERROR	22	An ICMP error occurred during the network operation.
EFI_TFTP_ERROR	23	A TFTP error occurred during the network operation.
EFI_PROTOCOL_ERROR	24	A protocol error occurred during the network operation.
EFI_INCOMPATIBLE_VERSION	25	The function encountered an internal version that was incompatible with a version requested by the caller.
EFI_SECURITY_VIOLATION	26	The function was not performed due to a security violation.
EFI_CRC_ERROR	27	A CRC error was detected.
EFI_END_OF_MEDIA	28	Beginning or end of media was reached.
EFI_END_OF_FILE	31	The end of the file was reached.
EFI_INVALID_LANGUAGE	32	The language specified was invalid.

Table B.4 EFI_STATUS Warning Codes (High Bit Clear)

Mnemonic	Value	Description
EFI_WARN_UNKNOWN_GLYPH	1	The Unicode string contained one or more characters that the device could not render and were skipped.
EFI_WARN_DELETE_FAILURE	2	The handle was closed, but the file was not deleted.
EFI_WARN_WRITE_FAILURE	3	The handle was closed, but the data to the file was not flushed properly.
EFI_WARN_BUFFER_TOO_SMALL	4	The resulting buffer was too small, and the data was truncated to the buffer size.

Index

A

ACPI 331, 335, 337, 343, 349, 351, 354
states
 G2/S5 99
 G3 99
 S1–S3 87
tables 86
Advanced RISC Computing (ARC) 6
AllocateBuffer 184, 187
AMT. *See* Intel® Active Management Technology
 (Intel AMT)
API 112, 335
Application
 Hello world 69–71
Application-Specific Integrated Circuit (ASIC)
 137
ARC. *See* Advanced RISC Computing (ARC)
Architectural Boot Mode
 PEIM-to_PEIM interface (PPI) 264
Architectural Protocols (APs) 129, 131–132,
 168–175
 Boot Device Selection Architectural Protocol
 147, 158, 163, 174–175
 CPU Architectural Protocol 147, 150, 170–
 173
 Driver Execution Environment (DXE)
 Architectural Protocol 144–152, 162, 176

 Metronome Architectural Protocol 129, 147,
 150
 Monotonic Counter Architectural Protocol
 129, 148
 Real Time Clock Architectural Protocol 148,
 172
 Reset Architectural Protocol 148, 174
 Runtime Architectural Protocol 147, 152
 Security Architectural Protocol 147, 151
 Status Code Architectural Protocol 148, 152
 Timer Architectural Protocol 129, 147, 173
 Variable Architectural Protocol 147, 175
 Watchdog Timer Architectural Protocol 147,
 176
architecture
 security 207
 Unified Extensible Firmware Interface (UEFI)
 21
ASCII 104, 109, 113, 244
Attributes
 Firmware Boot Manager 241
 PCI I/O Protocol 187
Authenticode 64, 222

B

Base Address Register (BAR) 185–188

- Baseboard Management Controllers (BMC) 349, 350, 352
- BDS. *See* Boot-Device Selection (BDS)
- BFV. *See* Boot Firmware Volume (BFV)
- BIOS
 - and legacy-option ROM 312
 - BootBlock 343
 - evolution 6
 - fixed topology 335
 - in embedded systems 324–325, 331
 - infrastructure elements 195–197
 - limitations 44, 342
 - marketing requirements 309
 - platform policy 310
 - real-world expectations 308
 - terminology 5
- Bit Field 94
- Block I/O Protocol 49, 76–77, 168, 188–191
- Boolean Expression 280
- Boot
 - devices 165
 - embedded systems 17, 323
 - firmware 268, 325
 - firmware volume (FV) 319
 - flow 18, 249, 261, 270, 272, 280
 - latency
 - boot storage devices 337
 - definition 325
 - flash storage access 326, 331, 332, 333, 336, 337, 338
 - OEM splash screen 326
 - optimized components 326
 - requirements 328
 - to active user interface time 332
 - to active User Interface time 326
 - loader 324, 326, 330, 332, 335, 336, 343
 - manager
 - firmware. *See* Firmware Boot Manager
 - Unified Extensible Firmware Interface (UEFI) 237
 - mechanisms 246
 - media 248
 - mode 278–279
 - defined 250
 - detection 286
 - PEIM-to-PEIM interface (PPI) 264
 - priority 251–253
 - register 263
 - sleep state 252
 - network booting 248
 - performance
 - architectural flow comparison 317
 - BIOS interaction 314
 - boot media 313
 - functional flow comparison 318
 - legacy option ROMs, perils of 312
 - marketing requirements 308, 309, 312
 - measurement results 309
 - non-optimized 316, 317
 - OEM splash screen 312, 329
 - optimized 316, 317, 320
 - requirements 303
 - time (total boot time) 308
 - unnecessary drivers, BIOS adjustment 315, 320
 - platform phase 141, 304
 - pre-boot phase 103, 169
 - Pre-EFI Initialization (PEI) phase 269
 - services
 - EFI Boot Services Table 150
 - in the UEFI Driver Model 52
 - terminating 165
 - system boot path 267
 - target 308, 316, 318, 319
 - time (total boot time) 313
 - variables 245
- Boot Device Selection (BDS) 133, 140, 148, 169
 - optimization 318
 - phase 163–166, 237, 307, 310, 311, 315, 317, 319
 - protocol 147, 158, 163, 174–175
- Boot Firmware Volume (BFV) 273–274

- Processor Abstraction Layer (PAL) 253
 - UEFI PI architecture 262
 - Boot Mode
 - priority 251
 - register 255, 263
 - sleep state 252
 - Boot Path
 - normal 254–256
 - recovery 257–259
 - reset 253
 - S0 255–256
 - special 259–260
 - S-State 256
 - Boot Strap Processor (BSP) 282
 - bridge 47
 - Brook's Law 83
 - BS. *See* Unicode Characters: backspace
 - Bus
 - driver 48, 50–54
 - PCI 47
 - Bus Specific Driver Override Protocol 51
- C**
- Cache-as-RAM (CAR) 284–286
 - CAR. *See* Cache-as-RAM (CAR)
 - Central Processing Unit (CPU) 21, 122, 178, 285, 308
 - Certificate Authorities (CAs) 64
 - CLI. *See* Command Line Interface (CLI)
 - Command Line Interface (CLI) 133
 - Configuration Access Protocol 196–198
 - Configuration Table 149
 - console
 - devices 164
 - services 77, 103, 132
 - splitter 116–118
 - stack 133
 - Consumer Electronics (CE) Device
 - boot challenges 325
 - boot strategies 335
 - firmware 342
 - firmware flow 334
 - generic requirements 332
 - interoperability 331
 - landscape 324
 - manageability framework 344
 - measured boot latency 344
 - platform 345
 - power management 337
 - security 340
 - storage devices 338
 - trust boundary 342
 - control center, smart home. *See* smart home control center
 - Controlled Data Items (CDIs) 232
 - Controllers
 - Host Bus Controllers 46–49
 - control sequence 113
 - Coreboot 285
 - CPU. *See* Central Processing Unit (CPU)
 - CPU Architectural Protocol 147, 171
 - CRC 174, 176
- D**
- Denial of Service 231
 - Dependency Expression 160, 275
 - supported op codes 161
 - Device Drivers 48–51, 53, 56
 - Device Handle 48–50
 - Device Path Protocol 47, 48, 74, 76, 183
 - Disk I/O Protocol 168, 190
 - Distributed Management Task Force (DMTF)
 - 350, 369
 - DMA Operations 171
 - DMTF. *See* Distributed Management Task Force (DMTF)
 - DRAM. *See* Dynamic RAM (DRAM)
 - Driver Binding Protocol 43, 45, 49–51
 - Driver Execution Environment (DXE)
 - applications 169, 216
 - architectural protocols (APs) 144–152, 162, 176, 267

- architecture 279
 - components 134, 279–280
 - core 139, 141–154, 231
 - and GCD memory space map 154
 - EFI System Table 143
 - handle database 143
 - handoff between PEI and DXE 142
 - Hand-Off Block (HOB) 141, 145
 - portability 141
 - dispatcher 139, 143, 145, 157–162, 230
 - dependency expression 160
 - handshake with components 159
 - priori file 160
 - services 152
 - drivers 128, 135, 139, 144, 162–163, 172, 173, 231, 269, 275, 279, 285
 - execution order 162
 - Portable Executable/Common File Format (PE/COFF) 143
 - subclasses 162
 - EFI Services 143, 144, 162
 - Foundation 129–131, 172, 283
 - handoff with Pre-EFI Initialization (PEI) 218
 - initial program load (IPL) 286, 324, 326, 330, 331, 338, 343
 - phase 139–141, 146, 255, 267–268, 278, 284, 310
 - services table 146, 152
 - specification 169
 - Driver Health Protocol 64
 - Driver Image Handle 45–47
 - Drivers 52, 118, 176, 183–185, 195–198
 - boot service 86, 170, 173
 - console 113–114
 - device 48–51, 185, 196
 - DXE 125, 128, 135, 169–170, 172–175, 173, 176
 - file system (FS) 193
 - initialization 44
 - model interactions 197
 - PCI 48, 177, 186, 188
 - runtime 86, 172
 - security 64
 - software 115
 - UEFI 26, 30, 46, 183, 197
 - video 112
 - Driver Support Services 151
 - Dual-Inline Memory Module (DIMM) 126, 311
 - DXE Foundation 170–171, 174, 175, 267
 - Dynamic RAM (DRAM) 285
- E**
- EBC. *See* EFI Byte Code (EBC)
 - EDK. *See* EFI Developer Kit
 - EDK I. *See* EFI Developer Kit
 - EFI. *See* Extensible Firmware Interface (EFI)
 - EFI Boot Services 145
 - table 150–151
 - EFI Byte Code (EBC) 31
 - EFI Configuration Table 149
 - EFI Developer Kit 5–6
 - EFI File Handle 168, 192
 - EFI Not Ready error 109
 - EFI Runtime Services Table 151–152, 172, 174
 - EFI Status Codes
 - code ranges 377
 - error codes 378
 - warning codes 379
 - Elevation of Privilege 231
 - El Torito logical block devices 191
 - Embedded Operating Systems 125, 331
 - Embedded Systems
 - booting 17
 - emulation firmware phases 294
 - Environment Variables 79
 - errors 103
 - EFI Not Ready error 109
 - error console device 105–106
 - UEFI Not Ready error 107
 - Event and Timer Services 150
 - Events
 - Hot Plug 53–63

- INIT 282
 - machine check architecture (MCA) 282
 - Unified Extensible Firmware Interface (UEFI) 37
 - Execute-In-Place (XIP) 284
 - Extensible Firmware Interface (EFI) 1, 2, 5, 6, 7, 8
 - boot services 168
 - and Driver Execution Environment (DXE) 143, 162
 - table 146, 150
 - components 1
 - configuration table 149
 - device path 196, 316
 - handle 196
 - history 6–7
 - OS loaders 71–75
 - protocol 289
 - runtime services
 - and Driver Execution Environment 162
 - table 151
 - system table 143, 148–151
 - components 149
- F**
- FFS 274, 276
 - File Allocation Table (FAT) 136
 - FilePath 246
 - File System (FS) 136
 - types 191
 - File System Protocol 75
 - Firmware 116, 180–183, 267–268
 - APIs 88
 - design, early 236
 - GUID 240
 - platform 104
 - platform initialization (PI) design 237
 - stack 84
 - Firmware Boot Manager 238–243
 - variables 238
 - Firmware Interface Table (FIT) 262
 - Firmware Volume File Format 143
 - Firmware Volume (FV) 220, 265, 284, 319
 - FIT. *See* Firmware Interface Table (FIT)
 - Floating-Point Software Assist (FPSWA) driver 36
 - Flush 184, 187, 190, 193
 - FPSWA driver. *See* Floating-Point Software Assist (FPSWA) driver
 - Framework
 - boot flow 13
 - components 2
 - definition 6
 - evolution to Platform Initialization (PI) 3
 - Front Side Bus (FSB) 273
 - FS. *See* File System (FS)
 - Function Call Definitions 103
 - Function Prototype 88–89, 93
 - Functions
 - AllocateBuffer 184, 187
 - Attributes 187
 - Close 193, 194
 - Configuration 185
 - CopyMem 184, 187
 - Delete 194
 - DisableInterrupt 171
 - DmaBufferAlignment 172
 - EnableInterrupt 171
 - Entry 175
 - ExitBootServices 30, 36
 - Flush 184, 187, 190, 193
 - FlushBlocks 190
 - FlushDataCache 171
 - FreeBuffer 184, 187
 - GenerateSoftInterrupt 174
 - GetAttributes 184
 - GetBarAttributes 187
 - GetInfo 194
 - GetInterruptState 171
 - GetLocation 187
 - GetMemorySpaceMap 170
 - GetNextVariableName 175
 - GetPosition 194
 - GetTime 172

GetTimerPeriod 173, 177
 GetTimerValue 172
 GetVariable 175
 GetWakeupTime 172
 Init 171
 Io 184, 187
 LoadImage 240
 Map 184, 187
 Media 190
 Mem 184, 187
 NewPackageList 199
 NumberOfTimers 172
 Open 194
 OpenVolume 193
 OS loader 34
 ParentHandle 184
 Pci 184, 187
 PollIo 184, 186
 PollMem 184, 186
 RaiseTPL 171
 Read 194
 ReadBlocks 190
 ReadDisk 191
 RegisterHandler 173, 177
 RegisterInterruptHandler 172
 Reset 190
 ResetSystem 174, 176
 RestoreTPL 171
 Revision 189, 191, 193, 194
 RomImage 188
 RomSize 188
 SegmentNumber 185
 SetAttributes 184
 SetBarAttributes 187
 SetInfo 194
 SetMemoryAttributes 170, 172
 SetMemorySpaceAttributes 170
 SetPosition 194
 SetTime 172
 SetTimer 173
 SetTimerPeriod 173, 177

SetVariable 176, 239
 SetWakeupTime 172
 SetWatchdogTimer 176
 Unmap 184, 187
 Write 194
 WriteBlocks 190
 WriteDisk 191

G

GCD. *See* Global Coherency Domain Services
 Global Coherency Domain Services 152
 I/O resources 156
 map
 memory space 152
 space 152
 memory resources 153
 and Driver Execution Environment (DXE)
 core 154
 Hand-Off Block (HOB) 154
 memory state transitions 155
 Global Variable Definitions 105
 GNU C compiler (GCC) 286
 GUID 193, 240, 277, 281, 289, 371
 and Driver Execution Environment (DXE) core
 143
 extension
 Hand-Off Block (HOB) 144
 protocol naming 29
 tag 31
 Unified Extensible Firmware Interface (UEFI)
 protocol 26

H

HAL. *See* Hardware Abstraction Layer (HAL)
 Handle 23
 and protocols 30
 Block I/O 76–77
 child 51
 component representations 24
 device 48–49
 driver image 45–47

- image 44
 - types 26
 - Handle Database 23–26
 - Driver Execution Environment (DXE) drivers 143
 - Hand-Off Block (HOB) 139, 154, 276, 278–280, 282
 - GUID extension 144
 - list 141, 144, 170, 278
 - and Pre-EFI Initialization (PEI) 143
 - PEI-to DXE handoff 279
 - Phase Handoff Information Table (PHIT) 143
 - Hardware Abstraction Layer (HAL) 336
 - Hardware Security Module (HSM) 211
 - healthcare, intelligent home environment.
 - See* intelligent home environment: healthcare
 - HMI. *See* human machine interface (HMI)
 - Host Bridge 47
 - Host-Bus Adapter (HBA) 64, 223
 - Host Bus Controllers 46–49
 - Hot Plug Events 53–63
 - HSM. *See* Hardware Security Module (HSM)
 - Human Interface Infrastructure (HII) 194–195
- I**
- IA-32 31
 - IBM
 - CMOS directives 90
 - IBVs. *See* Independent BIOS Vendors (IBVs)
 - ICE. *See* In-Circuit Emulator (ICE)
 - IDE. *See* Integrated Device Electronics (IDE)
 - IHV. *See* Independent Hardware Vendors (IHVs)
 - Image Handle 44, 45, 74
 - Images 31
 - Image Services 151
 - In-Circuit Emulator (ICE) 291
 - Independent BIOS Vendors (IBVs) 4, 43
 - Independent Hardware Vendors (IHVs) 43
 - Information Disclosure 231
 - Input/Output (I/O) 106
 - text I/O 113, 115, 116, 118
 - in-situ agents
 - debugger nub 285
 - Integrated Device Electronics (IDE) 135–137
 - Integrated Memory Controller (IMC) 122
 - Integrated Timer-Counter (ITC) 129
 - Integrity Model
 - roots of trust/guards 232
 - Intel® Active Management Technology (Intel AMT) 349, 350, 370, 371
 - Intel® Architecture Platforms 285
 - dynamic error handling framework 347, 348, 349, 351
 - Intel® Atom™ processor 130
 - and smart home control center. *See* smart home control center
 - and smart TV. *See also* smart TV
 - System on a Chip (SoC) 124, 325, 332, 335, 336, 340, 342
 - Intel® Core i7™ processor 122, 125
 - Intel® HT Technology. *See* Intel® Hyper-Threading Technology (Intel® HT Technology)
 - Intel® Itanium® 282–283
 - architecture range 377
 - boot flow 260–262
 - boot path, reset 253, 260
 - non-power-on 254
 - PowerGood 253
 - processor abstraction layer (PAL) 282
 - boot path, special
 - boot after INIT 259
 - boot after MCA 259
 - System Abstraction Layer entry point 259
 - UEFI PI architecture 262
 - Boot Firmware Volume (BFV) 262
 - Pre-EFI Initialization modules (PEIMs) 262
 - versus other Intel® processors 286
 - Intelligent Platform Management Interface (IPMI) 349, 350, 370, 371
 - Intel® Pentium® 4 processor 286
 - Internet Protocol (IP)
 - IPv6 224

Internet Small Computer Systems Interface (iSCSI)
65, 224, 225

In-Vehicle Infotainment (IVI) 323, 328, 332, 337

I/O. *See* Input/Output (I/O)

I/O Abstraction 46, 48–49, 171

protocols 172

I/O Protocol 48

I/O Resources 156

space map 156

IPMI. *See* Intelligent Platform Management

Interface (IPMI)

iSCSI. *See* Internet Small Computer Systems

Interface (iSCSI)

Itanium® 4, 6, 31, 127

IVI systems. *See* In-Vehicle Infotainment (IVI)

J

K

Key/Value Pairs 94

L

Lakeport 125

M

MAC. *See* Medium Access Layer (MAC)

Manageability. *See* Intel® Architecture Platforms:

dynamic error handling framework

Map 184, 187

Master Boot Record (MBR) 73

BIOS boot limitations 3

MBR. *See* Master Boot Record (MBR)

MDE. *See* Module Development Environment

(MDE)

Measured Boot 209

measurements 219

Memory Controller Hub Memory Controller 125

Memory Map 183

GCD memory space map 170

retrieving 78

Memory Services 150

Metronome 147

Microsoft

C compilers 286

DOS image format 285

Miscellaneous Services 98–101

Module Development Environment (MDE) 286

Monotonic Counter 148

MP. *See* Multiprocessor

MPS

tables 88

Multiprocessor 282

N

Network Boot 248

Network Console 118–120

Networking

UEFI drivers 65–66

Network Interface Controller 118

non-PCs 124

Nonvolatile Storage (NVS) 265

NT32 Platform 291

emulation 292–294

firmware 294

firmware emulation software logic flow 300

hardware pass-through 300

software flow 302

limitations 292, 300, 301

native API 294

WinNtThunk capability 294, 298, 299

NULL Interface Pointer 173, 174, 176

Null Unicode string 96

NVRAM Variable 238

O

Occam's Razor 267

OEM. *See* Original Equipment Manufacturers

(OEMs)

Open Firmware 6

Original Equipment Manufacturers (OEMs) 43, 281, 377

OS Kernel 72, 77, 78, 351
 transitioning 80

OS Loader 84–86, 92–93
 accessing files 75
 Extensible Firmware Interface 71–75
 memory map 78
 requirements for 71–72

OS Partition 76–77
 boot sequence 238

Out-Of-Band (OOB) 349

Output Devices 111–112

Output Strings 111

P

ParentHandle 184

Partition 76–77

PC 268
 PEI components 125
 system address map 122

PC ANSI 113

PCI. *See* Peripheral Component Interconnect (PCI)

PCI Bus 47, 51

PCI Device Drivers 48

PCI Express 4

PCI Protocols 168, 177–186
 PCI Host Bridge Resource Allocation Protocol 177–183
 PCI I/O Protocol 30, 185–188
 PCI Root Bridge I/O Protocol 183–185

PE/COFF. *See* Portable Executable/Common File Format (PE/COFF)

PEI Foundation 250

PEI Modules 121

PEIM-to-PEIM interface (PPI). *See* Pre-EFI Initialization (PEI): PEIM-to-PEIM interface (PPI)

Peripheral Component Interconnect (PCI) 43, 353
 base address registers 186
 bus drivers 177, 188
 buses 168, 177–190, 179
 bus numbers 186
 configuration header 185
 device numbers 186
 device path protocol 183
 function number 186
 host bridges 177
 host bus controllers 178–180
 host buses 179–180, 186
 I/O space 180–182
 memory space 180–182
 n host bridges 178
 option ROM 186
 PCI root bridge I/O protocols 180–182
 prefetchable memory space 180–181, 183
 root bridge protocol 133
 root bridges 177–185, 178
 segments 181, 186

Phase Handoff Information Table (PHIT)
 Hand-Off Block (HOB) 143

PHIT. *See* Phase Handoff Information Table (PHIT)

PI. *See* Platform Initialization (PI)

PIC. *See* Programmable Interrupt Controller (PIC)

PIWG. *See* Platform Initialization Working Group (PIWG)

Platform
 boot phase 141
 components 52–53

Platform Controller Hub (PCH) 125, 127, 131, 136–137

Platform Driver Override Protocol 53

Platform Error Reporting 348, 351, 354
 in-band errors 348, 349
 standardization 351
 intelligent platform management interface (IPMI) 371
 management model 354
 OS reporting stack 352, 353
 out-of-band errors 348, 350

- Platform Firmware 303
 - initialization 304
 - recovery 265, 313
- Platform Initialization (PI) 121, 276
 - architecture specification 377
 - boot flow 13, 305
 - components 2, 219
 - evolution of Framework 3
 - implementation
 - security elements 16
 - layering 11
 - protocols 4
 - security 205, 229
 - Specification 139, 167–168
 - System Management Mode (SMM) 4
 - Unified Extensible Firmware Interface (UEFI) 278, 282
- Platform Initialization Working Group (PIWG) 10–14
- Platform Manufacturer (PM) 229
- Platform Security 206
 - architecture 207, 208
 - assurance 209
 - authenticity 208
 - availability 208
 - confidentiality 208
 - firmware layer 208
 - hardware layer 208, 209
 - integrity 208
 - trust
 - definition 206
 - elements 206
 - measurement 206
 - roots of 213
 - security 206
 - vulnerability classification 231
- Platform Trust 14. *See also* Security
 - taxonomy of terms 213
- Portable Executable/Common File Format (PE/COFF) 44, 285
 - Certificate Authorities (CAs) 64
 - Driver Execution Environment (DXE) drivers 143
 - Preboot eXecution Environment (PXE) BIOS Support Specification 248
- Pre-EFI Initialization (PEI) 267
 - components 279
 - ComponentsDispatcher 306
 - dispatcher 230, 258, 274–275, 279–280, 283
 - Foundation 268–269, 273–278, 279–284
 - Hand-Off Block (HOB) list 143
 - PEI-to DXE handoff 279, 307
 - Phase Handoff Information Table (PHIT) 278
 - handoff with Driver Execution Environment (DXE) 218, 307
 - modules
 - Hardware Save Table 284
 - modules (PEIMs) 125, 134, 250, 254, 258–259, 268–269, 306
 - dependency expression 280–281
 - execution 281
 - Memory Controller Hub Memory Controller 125
 - PEIM-to-PEIM interface (PPI) 126, 127
 - Platform Controller Hub (PCH) 125
 - security PPI 281
 - UEFI PI architecture 262
 - verification/authentication 281
 - verification PPI 281
 - notifications 277
 - operation 279–280
 - PEIM-to-PEIM interface (PPI) 274, 280–282, 286, 288–290
 - architectural boot mode 264
 - phase 139, 218, 268, 317
 - design concepts 276–279
 - memory discovery 281
 - prerequisites 273–275
 - recovery 283–284
 - save-to-RAM resume (S3 resume) 284
 - services 277
 - services table 274, 276

Pre-operating system (pre-OS) agents 21, 71,
74–81, 85, 88, 89, 92, 94, 98, 101

Priori File 143, 145, 158, 160

Processor Abstraction Layer (PAL)
 Itanium® architecture 262, 351

Programmable Interrupt Controller (PIC) 131

Protocol Handler Services 151

Protocol Interface Structure 27

protocols 26–32
 ACPI editing 4
 Block I/O Protocol 76–77, 188
 Boot Device Selection Architectural Protocol
 174
 Bus Specific Driver Override Protocol 51
 Configuration Access protocol 196
 construction of 28
 CPU Architectural Protocol 170
 Device Path Protocol 47–48, 74–76
 Disk I/O Protocol 190
 Driver Binding Protocol 43, 56, 66
 Driver Health Protocol 64
 EFI Developer Kit II (EDKII) 28
 EFI File Protocol 193
 PCI Host Bridge Resource Allocation Protocol
 177
 PCI I/O Protocol 30, 185
 PCI Protocols 176
 PCI Root Bridge I/O Protocol 133, 183
 Platform Driver Override Protocol 53
 protocol interface structure 27
 Real Time Clock Architectural Protocol 172
 Reset Architectural Protocols 174
 Simple File System protocol 192
 Simple File System Protocol 136
 SIO 4
 SMBIOS 4, 311
 System Management Mode (SMM) 4
 Timer Architectural Protocol 173
 Variable Architectural Protocol 175
 Watchdog Timer Architectural Protocol 176

PS/2 keys 107, 109

pseudo code 56–57

PXE. *See* Preboot eXecution Environment (PXE)
 BIOS Support Specification

Q

R

read-only-memory C compiler (romcc) 285

Real Time Clock
 architectural protocols (APs) 148
 services 151

Recovery
 architecture 257–258
 platform firmware 265

Remote Console
 support 113–116

Remote Graphical Displays 165

Repudiation 231

Reset
 architectural protocols (APs) 148
 services 151

romcc. *See* read-only-memory C compiler (romcc)

RTC. *See* Time: RealTime Clock (RTC)

Runtime
 architectural protocols (APs) 147
 services 151

S

samples
 application 69–71
 child device handle 52
 device handle 47
 device path 74
 extract environment variables 79
 file - open, read, write, close 75
 hot plug events 54–55
 memory map 78
 OS loader 72–74
 OS partition 76
 pseudo code 61

- system configuration 77
 - SBP. *See* Service Binding Protocol (SBP)
 - Scan Codes 104, 107–109, 113
 - SCSI
 - drive 44
 - Security 14, 281
 - Architectural Protocols (APs) 147
 - platform 231
 - platform initialization (PI) 305
 - Platform Initialization (PI). *See also* Platform Initialization (PI)
 - primitives 274
 - UEFI drivers 64
 - User Identity (UID) infrastructure 64, 227
 - Security (SEC) phase 267, 273–275, 286
 - Serial Presence Detect (SPD) 126
 - Serial Terminal 164
 - Service Binding Protocol (SBP) 66
 - Simple File System Protocol 168, 192–195
 - Simple Text Input 104
 - Simple Text Input Ex 110
 - Smart phone 124
 - SMBIOS
 - tables 88
 - SMBUS. *See* System Management Bus (SMBUS)
 - SO Boot Path 255–256
 - SOC. *See* system-on-chip (SOC)
 - Software Handshake 169
 - Spoofing 231
 - S-State Boot Path 256
 - Status Code
 - architectural protocols (APs) 148
 - services 152
 - Steinbach’s Guideline for Systems Programming 103
 - Super I/O (SIO) 126, 289
 - System Address Map 121, 123
 - System Management BIOS (SMBIOS) 369
 - System Management Bus (SMBUS) 125–127, 286, 289
 - System Management Mode (SMM) 4
 - System Memory
 - descriptors 145
 - System-on-a-Chip (SoC) 124
 - System Table 22, 92, 104–106, 116
 - Extensible Firmware Interface (EFI) 148–151
- ## T
- Tablet 124
 - Tag GUID 31
 - Tampering 231
 - Task Priority Level (TPL) 39
 - Task Priority Services 150
 - TBB. *See* Trusted Building Block (TBB)
 - TCG. *See* Trusted Computing Group (TCG)
 - TCP/IP stack 118
 - TE. *See* Terse Executable
 - Telnet 165
 - Telnet daemon 118–119
 - temporary RAM 273
 - Terse Executable 284–286
 - Text Interface 105, 112
 - Text I/O 106
 - The “H” 269
 - Thunk Protocol 298, 299
 - Tiano 6
 - Timer Architectural Protocol 129
 - architectural protocols (APs) 147
 - NT32 129–130
 - TLB. *See* Translation Look-up Blocks (TLB)
 - TPL. *See* Task Priority Level (TPL)
 - TPM. *See* Trusted Platform Module (TPM)
 - Transient System Load (TSL) 84
 - Translation Look-up Blocks (TLB) 37
 - TRS. *See* Trusted Platform Module (TPM)
 - Trusted Building Block (TBB) 211–212
 - Trusted Computing Group (TCG) 209
 - Trusted Platform Module (TPM) 135, 341
 - boot flow 216
 - boot time line 230
 - CRTM 213, 218, 220, 343, 344
 - definition 209

- DRTM 213, 214, 215, 228
 - DTRM 228
 - elements 211
 - functions 215
 - measured boot 209, 331, 341, 342
 - measured launch environment 228
 - overview diagram 211
 - PCR 344
 - physical presence 214
 - platform configuration registers (PCRs) 213, 214, 217, 219
 - point of measurements. *See* Point of Measurements
 - RTM 213, 215
 - RTR 213
 - RTS 213
 - specification 342
 - SRTM 214, 215, 219, 222, 228, 233
 - TCG 217
 - UEFI APIs 216
 - layering 217
 - UEFI platform execution measured objects 218
 - TSL. *See* Transient System Load (TSL)
- U**
- UCST – UEFI Configuration Sub-team 9
 - UDK. *See* UEFI Development Kit (UDK)
 - UEFI. *See* Unified Extensible Firmware Interface (UEFI)
 - UEFI API 72, 226
 - UEFI Application Toolkit 29, 311, 318
 - UEFI Boot Manager 46, 52, 221
 - UEFI Developer Kit
 - version II (EDKII) 28, 31
 - UEFI Development Kit (UDK) 6, 286
 - UEFI Error Format Standardization 348, 349, 351
 - Windows Hardware Error Architecture (WHEA) 370
 - UEFI Events 37–39, 313
 - UEFI Forum 4–10
 - development of 7
 - hierarchy 9
 - members 8
 - subteams
 - UCST – UEFI 9
 - USST – UEFI Security 10
 - UEFI Image 31, 216, 222
 - advantages 32
 - and applications 35
 - and boot service 32
 - and drivers 35–37
 - and OS loader 35
 - and start function 32
 - boot sequence 238
 - events 37
 - storage locations 32
 - types 247
 - descriptions 34–35
 - relationships 33
 - UEFI OS loaders 86
 - UEFI runtime services table 90
 - UEFI Secure Boot 221
 - UEFI Shell 292
 - UEFI Simple Text Input 104, 106–109
 - UEFI Simple Text Input Ex 104–105, 109–110
 - UEFI Simple Text Output 104, 110–112
 - UEFI Specification 113
 - 2.1 104, 111, 112, 194, 315
 - 2.2 221, 223
 - 2.3 21, 28, 36, 47, 64, 226
 - history 11–12
 - UEFI Specification Working Group (USWG) 10
 - Uncontrolled Data Items (CDIs) 232
 - UNDI Driver. *See* Universal Network Driver Interface (UNDI): driver
 - Unicode Characters 104, 107–108, 111–113
 - Unified Extensible Firmware Interface (UEFI)
 - applications 104, 105, 118, 167–168, 373
 - architecture 21, 69, 304
 - BIOS 196, 331, 335
 - boot manager 237
 - boot sequence 238

- boot services 188, 192, 221
- components 1, 167
- configuration infrastructure 194–196, 197
- configuration table 88–89, 92–93
- data types 373–375
- driver model 43, 46, 48, 50, 52, 53, 197
- drivers 105, 167–168, 183, 312, 373
 - management 64
 - networking 65–66
 - security 64, 219
 - signing 223
- embedded operating system 17
- executable verification 222
- firmware 191, 224, 291, 303
 - emulation environment. *See* NT32 Platform
 - root-of-trust-for-verification (RTV) 222, 228
- GUID 88, 92, 94–95
- hardware API handler 298
- images 31–39
- Input Key 107
- interaction with hardware devices 291
- IPsec 224, 225
- key 107
- layering 11
- memory 85–88
- networking 224
- network stack 226
- objects managed by firmware 22
- OS loaders 104
- platform execution measured objects 218
- Platform Initialization (PI) 220, 229, 249, 267, 278, 282, 311
 - components 219, 269
 - execution phases 250
 - flash file system 273–275, 279, 283
- pointer pairs 88, 92
- pre-operating system (pre-OS) agents 21, 71, 74–81, 85, 88, 89, 92, 94, 98, 101
- protocol definitions 88
- protocols 26, 194
- runtime 83–87

- runtime services table 88–92
- secure boot 221
- security 14, 205, 229. *See also* Unified Extensible Firmware Interface (UEFI)
- services
 - boot 22, 83–87, 90, 94–99
 - console 103–120
 - protocol 23
 - runtime 23, 97–100
- shell command line 71
- software 104
- software stack 221
- specifications 1, 90, 220, 227, 377
- SRTM 215
- system table 22, 92, 104–106, 116
- Task Priority Level (TPL) 40
- TCG platform specification 217
- trust 221
- user identification (UID) 227
- Universal Network Driver Interface (UNDI) 24, 36, 88, 118
- Universal Serial Bus (USB) 43, 53, 64, 67, 310, 313
- USB. *See* Universal Serial Bus (USB)
- User Identity (UID) infrastructure 64
- USST – UEFI Security Sub-team 10
- USWG. *See* UEFI Specification Working Group (USWG)

V

- variable
 - architectural 98
 - architectural protocols (APs) 147
 - boot option 245
 - BS attribute 242
 - environment 79, 176
 - firmware boot manager 238
 - globally-defined 242
 - load option 241
 - nonvolatile 242
 - NVRAM 238

services 94–99, 151, 243–245

Variable Write

architectural protocols (APs) 148, 176

Video Adapters 164

Virtual Address 86, 92–94, 100

Virtual Memory Services 88, 92–93, 100, 152

VT-100 113, 120

Vulnerability Classification 231

W

Watchdog Timer

architectural protocols (APs) 147

Web Services Management Protocol 350, 364,
368–370, 372

WHEA. *See* Windows Hardware Error Architecture
(WHEA)

Windows Authenticode Portable Executable

Signature Format 64

Windows Hardware Error Architecture (WHEA)
350, 370, 371

WinNtThunk Capability 294, 298, 299

Wired for Management Baseline specification 248

WS-MAN. *See* Web Services Management Protocol

X

XIP. *See* Execute-In-Place (XIP)

Y

Z

Continuing Education is Essential

It's a challenge we all face – keeping pace with constant change in information technology. Whether our formal training was recent or long ago, we must all find time to keep ourselves educated and up to date in spite of the daily time pressures of our profession.

Intel produces technical books to help the industry learn about the latest technologies. The focus of these publications spans the basic motivation and origin for a technology through its practical application.



Right books, right time, from the experts

These technical books are planned to synchronize with roadmaps for technology and platforms, in order to give the industry a head-start. They provide new insights, in an engineer-to-engineer voice, from named experts. Sharing proven insights and design methods is intended to make it more practical for you to embrace the latest technology with greater design freedom and reduced risks.

I encourage you to take full advantage of Intel Press books as a way to dive deeper into the latest technologies, as you plan and develop your next generation products. They are an essential tool for every practicing engineer or programmer. I hope you will make them a part of your continuing education tool box.

Sincerely,



*Senior Fellow and Chief Technology Officer Intel
Corporation*

**Turn the page to learn about titles
from Intel Press for system developers**



Harnessing the UEFI Shell

Moving the platform beyond DOS

By Michael Rothman, Tim Lewis, Vincent Zimmer and Robert Hale

ISBN 0-9764832-1-1

The Unified Extensible Firmware Interface (UEFI) Shell was designed for programmers who are writing automation process software for computer-based equipment.

In *Harnessing the UEFI Shell* the authors describe the features and capabilities of the shell for the UEFI explaining that the UEFI is not an operating system per se, but is instead intended to be a set of defined interfaces between the system firmware (BIOS), Option ROMs, and operating systems. The richness of the interfaces required for this main purpose secondarily provides the interfaces that can support a rich command line environment, the UEFI Shell.

Included are detailed descriptions of how to use the UEFI Shell with many real life examples such as specialized memory tests for chip and board validation and manufacturing validation tests. Written specifically for the practicing software engineer, this book enables the reader to quickly become proficient in using and exploiting the UEFI Shell.

The UEFI Shell is, in the end, useful because it is small and not intrusive, just as its cousins are useful because they are large and all-encompassing.

Harnessing the UEFI Shell

Moving the platform beyond DOS

Michael Rothman, Tim Lewis, Vincent Zimmer and Robert Hale



Intel
PRESS

Books by Engineers, for Engineers



“Harnessing the UEFI Shell is a perfect sequel to the Beyond BIOS book. If you are still using or shipping DOS-based solutions, this book is definitely a must-read for all software development engineers. It provides an important bridge between the normative specifications and the informative details of the development and the insights provided by the authors”

*Dong Wei
Vice President and Chief Executive,
the Unified EFI Forum
HP Distinguished Technologist*

Break Away with Intel® Atom™ Processors

A Guide to Architecture Migration

By Lori Matassa and Max Domeikai

The Intel® Atom™ processor enables a broader use of Intel® architecture in low power, form factor constrained devices such as media phones, home energy monitors, and in-vehicle infotainment. The challenge for the software developer is in understanding how to migrate their software from other architectures to Intel® Atom™ processor-based systems.

Break Away with Intel® Atom™ Processors: A Guide to Architecture Migration provides insight into architecture migration by addressing real world software migration issues, detailing topics such as architecture, system initialization, operating systems, graphics drivers, software tools, and the Intel® Atom™ processor capabilities.

Embedded debugging and performance tuning are covered in depth, and guidelines for a migration plan are provided. The reality is that architecture migration is not a one-size-fits-all activity. The key to a successful migration is assessing the situation and understanding decisions that need to be made and solution choices that are available. The authors deliver this information as a handbook to your software migration plan and project activities.

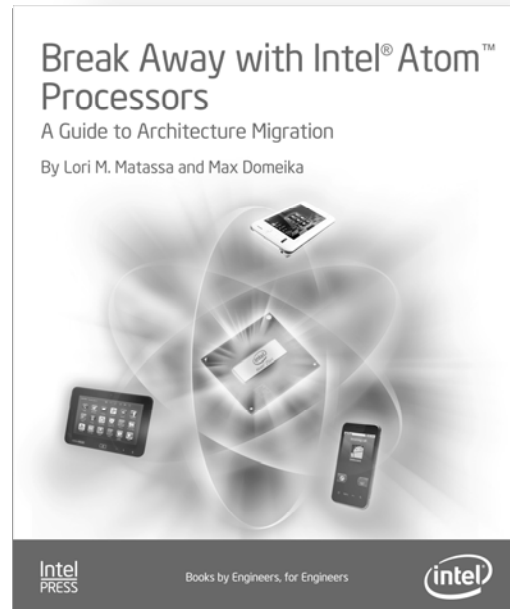

"This is an essential guide to working with the Intel® Atom™ processors that should be read by anyone who wants to understand how to use the platform effectively.

The book covers key concepts including power management, parallel applications, and machine virtualization, while providing a clear explanation of the system architecture and how to use it to its fullest advantage."

- Paul Krzyzanowski, CTO,

The Software Optimization Cookbook, Second Edition

High-Performance Recipes for IA-32 Platforms

By Richard Gerber, Aart J.C. Bik, Kevin B. Smith, and Xinmin Tian

ISBN 0-9764832-1-1

The Software Optimization Cookbook, Second Edition, provides updated recipes for high-performance applications on Intel platforms. Through simple explanations and examples, four experts show you how to address performance issues with algorithms, memory access, branch prediction, automatic vectorization, SIMD instructions, multiple threads, and floating-point calculations.

Software developers learn how to take advantage of Intel® Extended Memory 64 Technology (Intel® EM64T), multi-core processing, Hyper-Threading Technology, OpenMP†, and multimedia extensions. This book guides you through the growing collection of software tools, compiler switches, and coding optimizations, showing you efficient ways to improve the performance of software applications for Intel platforms.

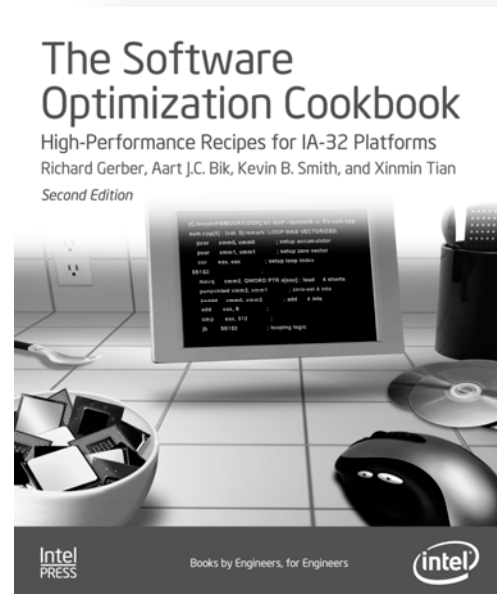

“This book simplifies the task for engineers who strive to develop high-performance software...”

*Lars Petter Endresen,
Doctor of Engineering, Physics,
Scandpower Petroleum Technology*

Special Deals, Special Prices!

To ensure you have all the latest books
and enjoy aggressively priced discounts,
please go to this Web site:

www.intel.com/intelpress/bookbundles.htm

Bundles of our books are available,
selected especially to address the needs
of the developer. The bundles place
important complementary topics at
your fingertips, and the price for a
bundle is substantially less than
buying all the books individually.

About Intel Press

Intel Press is the authoritative source of timely, technical books to help software and hardware developers speed up their development process. We collaborate only with leading industry experts to deliver reliable, first-to-market information about the latest technologies, processes, and strategies.

Our products are planned with the help of many people in the developer community and we encourage you to consider becoming a customer advisor. If you would like to help us and gain additional advance insight to the latest technologies, we encourage you to consider the Intel Press Customer Advisor Program. You can **register** here:

www.intel.com/intelpress/register.htm

For information about bulk orders or corporate sales, please send email to bulkbooksales@intel.com

Other Developer Resources from Intel

At these Web sites you can also find valuable technical information and resources for developers:

www.intel.com/technology/rr	Recommended Reading list for books of interest to developers
www.intel.com/technology/itj	Intel Technology Journal
www.developer.intel.com	General information for developers
www.intel.com/software	Content, tools, training, and the Intel Early Access Program for software developers
www.intel.com/software/products	Programming tools to help you develop high-performance applications
www.intel.com/embedded	Solutions and resources for embedded and communications

Beyond BIOS

Developing with the Unified Extensible Firmware Interface

In just a few days, a programmer familiar with C should have a good understanding of how to get started writing UEFI drivers and applications. For those who haven't developed PC BIOS firmware, Beyond BIOS Second Edition presents an opportunity to ramp up on the industry standard firmware platform for PCs and start writing UEFI apps as they do apps for today's mobile operating systems."

—Steve Jones, Chief Technology Officer, Phoenix Technologies Ltd.

"I feel qualified to highly recommend this book as a "deep dive" into the UEFI specifications and the flexibility these standards give to those who choose them. This publication is full of practical information and real-world examples for system designers and can empower them to get and keep a competitive edge in their designs. I would like to commend Intel for compiling such a valuable resource."

—S. Shankar, President and CEO, American Megatrends Inc. (AMI)

"Our customers were able to gain efficiency and time-to-market advantage from legacy BIOS to Framework and EFI, we however clearly foresee a broader set of benefits with the evolution to UEFI 2.3 and PI 1.2 as they become ever-more-widely adopted industry standards. Beyond BIOS Second Edition provides an extremely thorough yet lucid explanation of UEFI and PI that should be helpful to anyone that wants to understand or use this modern firmware environment."

—Jonathan Joseph, Executive Vice President, Insyde Software

"For many years, the software engineers working in the area of BIOS were dissatisfied by the lack of a good reference book, and could only learn the related knowledge through years of hard work. I now require my engineers and students to study this book after their initial UEFI firmware training. Experienced engineers will also find this book helpful for providing a quick overview of firmware architecture."

—KangKang Shen, CTO, Nanjing Byosoft. Ltd.

In *Beyond BIOS Developing with the Unified Extensible Firmware Interface* the authors have updated the successful first edition to include the latest UEFI specifications and have expanded the scope of the book to include support of embedded and SOC platform designs.

Visit our Web site at: www.intel.com/intelpress

Register your book to download the Digital Edition of this book and receive information about forthcoming books in your area of interest



7 35858 21565 7

ISBN 978-1-934053-29-4



9 781934 053294



Printed on Recycled Material

Cover Design by Ted Cyrek

ABOUT THE AUTHORS

VINCENT ZIMMER is a Principal Engineer in the Software and Services Group at Intel Corporation and has over 18 years experience in embedded software development and design, including BIOS, firmware, and RAID development. Vincent received an Intel Achievement Award and holds over 200 patents. He has a Bachelor of Science in Electrical Engineering degree from Cornell University, Ithaca, New York, and a Master of Science in Computer Science degree from the University of Washington, Seattle.

MICHAEL ROTHMAN is a Senior Staff Engineer in the Software and Services Group at Intel and has more than 20 years of operating system and embedded software development experience, Michael holds over 200 patents and was awarded an Intel Achievement Award on some of his systems work. He started his career with kernel and file system development in OS/2 and DOS and eventually migrating to embedded operating systems work and firmware development.

SURESH MARISSETTY is a software & systems architect at Intel Corporation and has been involved with enabling of various end-to-end platform technology ingredients across the industry. He has been with Intel for over 21 years and currently holds two Intel Achievement Awards, about 24 patents, a dozen internal and external papers on various topics and areas of expertise include: Security, Manageability/Machine Check Architecture, Low Latency Boot Solutions, End-to-End In-Vehicle-Infotainment platform architecture.

Zimmer
Rothman
Marisetty

Beyond BIOS
Developing with the Unified Extensible Firmware Interface

Intel
PRESS

Intel
PRESS